

Session 3

RADIOIODINE

TUESDAY: August 3, 1982

Co-CHAIRMEN: T.R. Thomas, Exxon Nuclear
Idaho Co.

J.D. Christian, Exxon Nuclear
Idaho Co.

ORGANIC IODINE REMOVAL FROM SIMULATED DISSOLVER OFF-GAS
STREAMS USING PARTIALLY EXCHANGED SILVER MORDENITE
R.T. Jubin

A PARAMETRIC STUDY ON REMOVAL EFFICIENCY OF IMPREGNATED
ACTIVATED CHARCOAL AND SILVER ZEOLITE FOR RADIOACTIVE
METHYL IODIDE
H. Shiomi, Y. Yuasa, A. Tani, M. Ohki, T. Nakagawa

DATA ANALYSIS OF IN PLACE TESTS OF IODINE FILTERS IN THE
FRENCH NUCLEAR FACILITIES
P. Mulcey, L. Trehen, J.L. Rouyer

IODINE FILTERING FOR FRENCH REPROCESSING PLANTS
G. Bruzzone, J.L. Rouyer, Ph. Mulcey, A. Vaudano

RETENTION OF ELEMENTAL RADIOIODINE BY DEEP BED CARBON FILTERS
UNDER ACCIDENT CONDITIONS
H. Deuber, J.G. Wilhelm

EXPERIENCES WITH A CHARCOAL GUARD BED IN A NUCLEAR POWER
PLANT
L.C. Scholten

DEPOSITION OF AIRBORNE RADIOIODINE SPECIES ON SURFACES OF
METALS AND PLASTICS
M.J. Kabat

Consolidated Fuel Reprocessing Program

ORGANIC IODINE REMOVAL FROM SIMULATED DISSOLVER
OFF-GAS STREAMS USING PARTIALLY EXCHANGED SILVER MORDENITE*

R. T. Jubin, Fuel Recycle Division
Oak Ridge National Laboratory
Oak Ridge, Tennessee 37830

ABSTRACT

The removal of methyl iodide by adsorption onto silver mordenite was studied using a simulated off-gas from the fuel dissolution step of a nuclear fuel reprocessing plant. The methyl iodide adsorption of partially exchanged silver mordenite was examined for the effects of NO_x , humidity, filter temperature, and degree of silver exchange. Partially exchanged silver mordenite, in general, achieved significantly higher silver utilizations than the fully exchanged material. Silver utilizations of $>95\%$ were achieved, assuming the formation of AgI. The experimental results indicate that CH_3I loadings increase proportionally with silver loading up to 5 wt % silver and then appear to level off. Tests conducted to determine the effect of temperature on the loading showed higher loadings at 200°C than at either 150 or 250°C . The presence of NO , NO_2 , and H_2O vapor showed negligible effects on the loading of CH_3I . In contrast to iodine loaded onto fully exchanged silver mordenite, the iodine loaded onto the partially exchanged silver mordenite could not be stripped by either 4.5% hydrogen or 100% hydrogen at temperatures up to 500°C .

A study of the regeneration characteristics of fully exchanged silver mordenite indicates a decreased adsorbent capacity after complete removal of the iodine with 4.5% hydrogen in the regeneration gas stream at 500°C . The loss of adsorbent capacity was much higher for silver mordenite regenerated in a stainless steel filter housing than in a glass filter housing.

A cost evaluation for the use of the partially exchanged silver mordenite shows that the cost of the silver mordenite on a once-through basis is $<\$10/\text{h}$ of operation for a 0.5-t/d reprocessing plant.

1. Introduction

Iodine-129 is produced by both natural and man-made sources. The natural sources include the spontaneous fission of uranium and the interaction of cosmic rays with xenon in the atmosphere. The annual production through these natural paths is ~ 10 mg/year. With its long half-life (1.6×10^7 years), ^{129}I tends to accumulate worldwide. As of 1940, the estimated accumulation has been reported to be 2×10^5 g.¹ A light-water reactor (LWR) will produce 234 g of ^{129}I per ton of fuel based on a uranium burnup of 30 000 MWd/t.² In handling the spent fuel, a single 5-t/d nuclear fuel reprocessing plant would have to process 3.2×10^5 g/year of ^{129}I . In addition to ^{129}I , various amounts of other short half-life iodine isotopes are also produced; however, none of these appear in significant amounts after long (200-d) decay times.

*Research sponsored by the Office of Spent Fuel Management and Reprocessing Systems, U.S. Department of Energy, under Contract No. W-7405-eng-26 with Union Carbide Corporation.

During the past two decades, various systems have been studied to reduce the iodine released to the environment. Two liquid scrubber systems are currently available: the Iodex system and the mercuric nitrate-nitric acid (Mercurex) system. Solid sorbents have also been studied, either as secondary systems to provide final filtering following use of either the Iodex or Mercurex system or as primary systems to replace the liquid based methods. These solid sorbents include silver faujasite, silver mordenite, alumina silicates, and macroreticular resins. Activated carbon has also been examined as a reference material; however, this material cannot be considered as a primary sorbent for treating reprocessing plant off-gas because of its low ignition temperature and its adverse reactions with nitrogen oxide (which could lead to the formation of explosive compounds and to poisoning by organic contaminants in the off-gas).

If high decontamination factors (DF's) are required, one of the more promising systems for primary iodine removal is the Iodex system; otherwise, solid sorbent-based processes tend to be favored. The Iodex system has already been tested on an engineering scale and has demonstrated good capabilities and operability. Decontamination factors in excess of 10^6 have been obtained. There are, however, concerns about the long-term integrity of the materials of construction that come in contact with the 20 to 23 M HNO₃ scrub solution.

Silver-impregnated solid sorbents offer a simpler iodine removal scheme in comparison to liquid systems. In this case, however, iodine DF's are limited to about 10^3 , and high operating costs can be expected, particularly if the silver is not recovered. In the past few years, regenerable adsorbents have received considerable attention.

At the 14th ERDA Air Cleaning Conference,³ it was reported that silver-exchanged faujasite (AgX) loaded with elemental iodine could be regenerated in situ with a pure hydrogen stream at 500°C; however, a 50% loss in loading capacity was observed after five loading cycles. Silver-exchanged faujasite is capable of adsorbing iodine at temperatures as high as 500°C; and like most other sorbents, it is adversely affected by water vapor, especially when condensation occurs. Faujasite is also adversely affected by acid vapor found in the dissolver off-gas system. Average I₂ loadings were 100 to 200 mg I₂ per g AgX or 23 to 47% utilization of the available silver.

A silver-containing alumina silicate, AC-6120, also showed potential on a once-through basis. Silver utilizations of ~59% have been reported with AC-6120.

Similar studies with silver mordenite (AgZ) showed only a negligible reduction in loading capacity after eight cycles.⁴ Average I₂ loadings were 100 to 130 mg I₂ per g AgZ or 42 to 55% utilization of the available silver. However, these tests were limited to elemental iodine loading.

The high cost of silver, the lack of an available AC-6120 regeneration scheme plus limited regeneration potential, and the lack of acid resistance of the AgX make these materials less attractive than AgZ for large-scale use.

Previous work on AgZ at the Oak Ridge National Laboratory was reported at the 16th DOE Air Cleaning Conference.⁵ This work demonstrated the increased loading of CH₃I following hydrogen pre-treatment of the AgZ. Hydrogen stripping of the iodine loaded bed was also demonstrated; however, the regeneration procedure caused a dramatic loss in the iodine loading capacity of the bed.

The objectives of the solid sorbent studies reported here were to evaluate:

1. the suitability of silver-exchanged mordenite as a back-up or secondary iodine removal system to the Iodex process in nuclear fuel reprocessing plants;
2. the removal capabilities of silver-exchanged mordenite for organic iodides;
3. the use of low silver content mordenite for iodine removal; and
4. the regeneration potential of both fully and partially exchanged silver mordenite.

2. Experimental Procedure

Silver-exchanged mordenite (AgZ) was prepared by ion exchange with 0.16-cm-diam extrudates of the sodium form of Norton Zeolon 900; silver-exchanged faujasite (AgX) and lead-exchanged faujasite (PbX) were prepared from 0.16-cm-diam extrudates of the type 13X Linde molecular sieve. Fully exchanged AgZ or PbX was prepared by placing 1500 g of the unexchanged zeolite into an ion exchange column and batch contacting with 3 L of 1 M silver nitrate or lead nitrate solution at 40°C. The spent solution was replaced at regular intervals with fresh solution until no change in silver or lead concentration was detected. The solution was drained, and the exchanged zeolite was air dried at 60°C for 24 h. Fully exchanged silver mordenite was also purchased from the Ionex Corporation under the trade name of Ionex Ag-900. Partially exchanged silver mordenite (LAgZ) was prepared by contacting unexchanged mordenite in a stirred tank reactor with a limited amount of silver nitrate solution and air dried at 60°C. During this exchange, virtually all of the silver from the solution is substituted for sodium in the zeolite structure. Thus, the degree of exchange is easily controlled by limiting the quantity of silver available. The AgZ beds were pretreated *in situ* prior to sorbent tests by heating to 200°C and purging with 4.5% H₂-95.5% Ar at a flow rate of 5 L/min for 24 h. The beds were then isolated and brought to the operating temperature. The same procedure was used to pretreat the LAgZ beds. The hydrogen pretreated condition of AgZ and LAgZ is denoted by Ag₂Z and LAg₂Z respectively.

Methyl iodide loading tests were conducted using an apparatus similar to that used in previously reported work.⁵ A schematic of the equipment is presented in Fig. 1. Heated air streams containing the

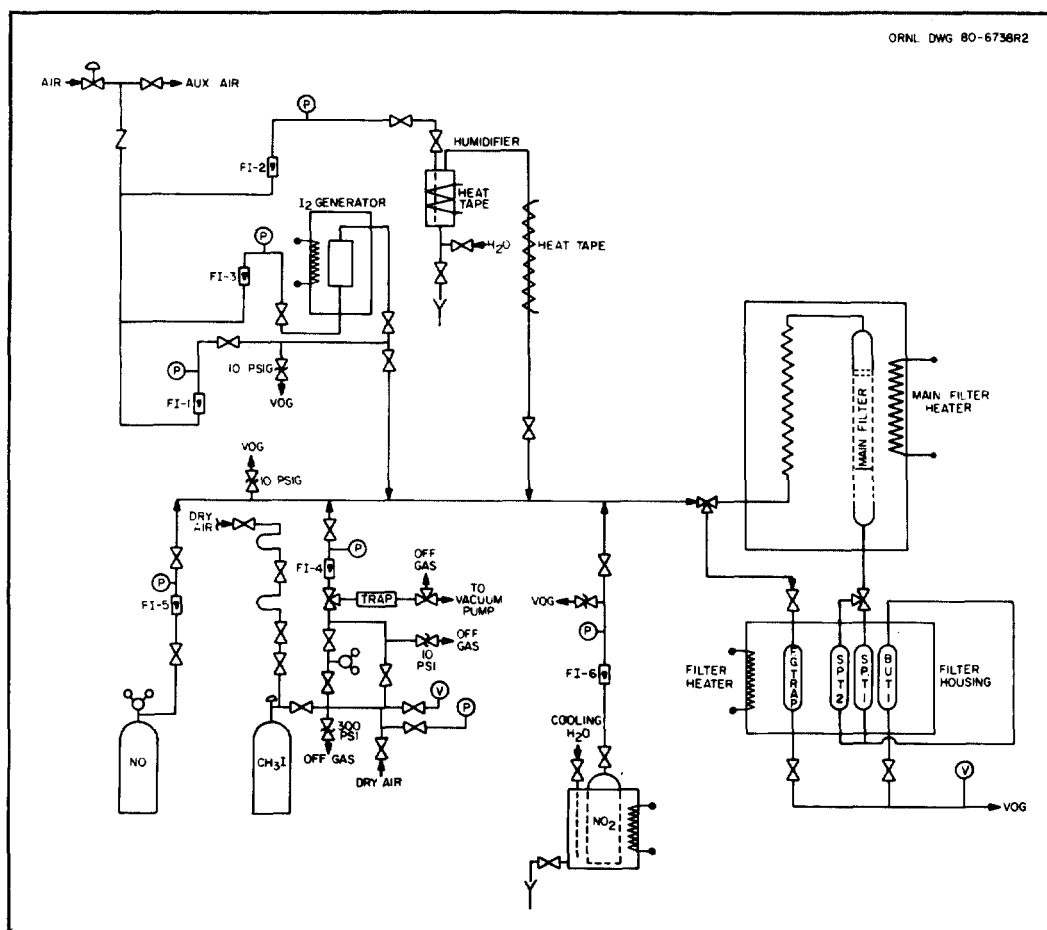

Fig. 1. Test apparatus for methyl iodide loading studies.

desired amount of NO, NO₂, CH₃¹²⁷I tagged with CH₃¹³¹I, and water vapor were passed through the segmented filter bed located in the heated main filter enclosure. Initial studies were conducted using a glass filter casing. A stainless steel filter divided into six segments (Fig. 2) was used in later experiments. The breakthrough of the bed was monitored by collecting the CH₃I, leaving the main filter on AgX. At regular intervals, this trap was removed and counted for ¹³¹I. Normally, when >0.1% of the iodine in the feed gas stream was found to be passing through the main filter, the run was stopped. The bed segments were counted for ¹³¹I using a sodium iodide detector and a single channel analyzer set on the 364-keV gamma-ray peak of 8-d half-life ¹³¹I. Using a 100-keV window, the gross count over a 1-min period (corrected for background) was used as a measure of the iodine content of the bed. The total amount of CH₃I loaded on the test bed was then calculated from the known ratio of ¹²⁷I to ¹³¹I.

ORNL DWG. 80-15046R

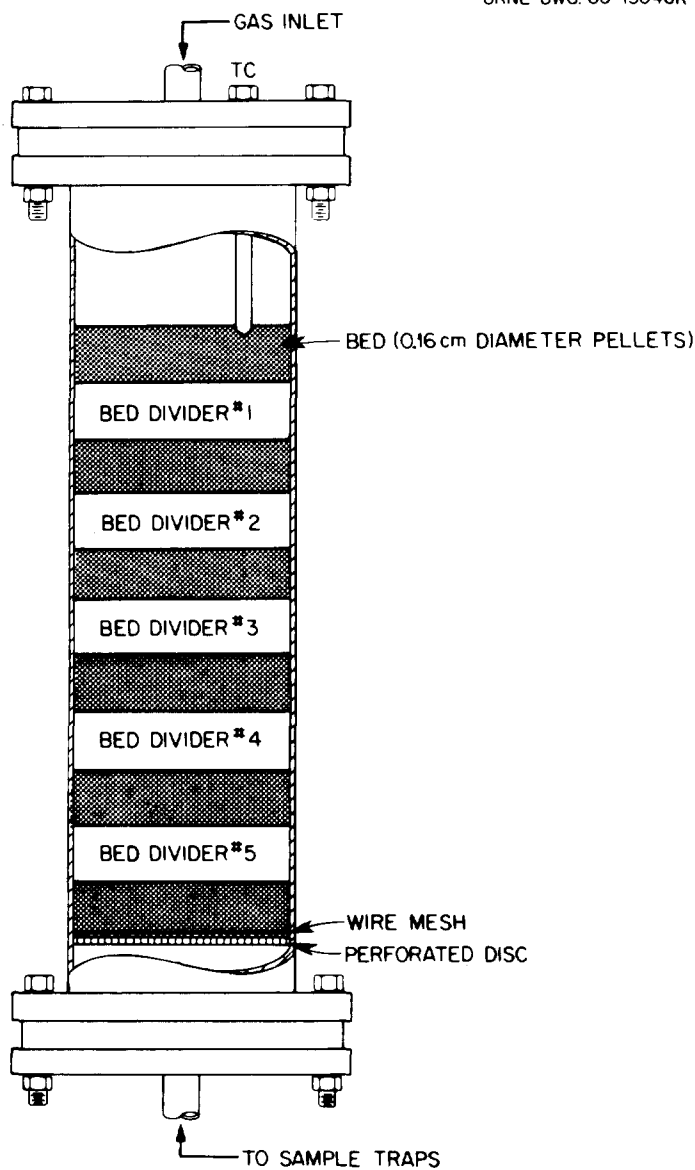

Fig. 2. Stainless steel main filter.

3. Experimental Results

3.1 Temperature and Humidity Effects on AgZ

The effects of NO, NO₂, humidity, pretreatment conditions, operating temperature, and CH₃I concentration on the loading capacity of AgZ were evaluated using an eight-run fractional 2ⁿ factorial-designed experiment.⁵

Analysis of those data indicated that (1) pretreatment with 4.5% H₂–95.5% Ar at 200°C for 24 h improved loadings; (2) loadings were improved at higher operating temperatures; (3) loadings were improved in moist air conditions; and (4) the other variables, NO, NO₂, and CH₃I concentration, produced variations in loadings that were less than the response error.

A follow-on study was conducted to examine the effects of temperature and humidity on AgZ. An air stream containing 1000 mg of CH₃I per m³ and a dewpoint of either approximately –54°C or approximately +35°C was passed across four hydrogen pretreated beds operated in series at temperatures of 100, 125, 150, 175, 200, or 225°C. The CH₃I loading on the first of four 2.54-cm-thick beds at breakthrough is shown in Fig. 3 as a function of temperature. Breakthrough, for this study, is the point where the DF across the main test beds drops below 10³.

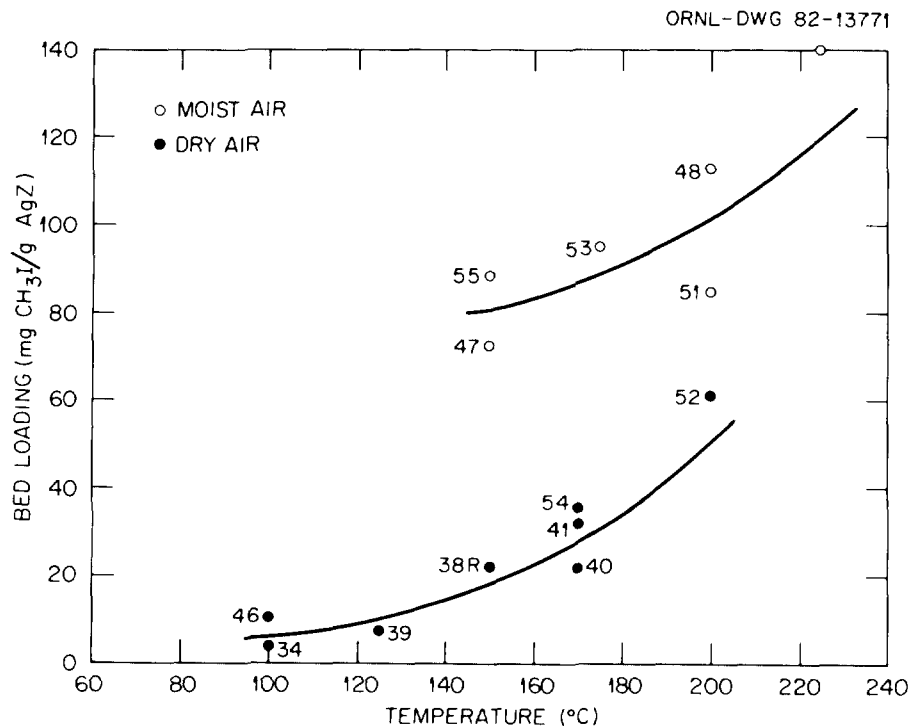

Fig. 3. CH₃I loading at breakthrough on the first of four 2.54-cm-deep beds as a function of temperature.

As indicated by the original scoping study, the presence of water in the system resulted in higher CH₃I loadings. As the operating temperature increases, loadings also increase, and the mass transfer zones (MTZ) are also increased. At 150°C, the MTZ for both the humidified bed and the dry bed is 5 to 7.5 cm in length. At 200°C, the MTZ is over 10 cm. As a result, the entire MTZ was not contained within the four test beds. Hence, even higher bed loadings should be expected prior to breakthrough on longer beds. This, in fact, was demonstrated during one experiment at 200°C with moist air. The run was continued past breakthrough and was terminated at a first bed loading of 139.5 mg CH₃I/g AgZ. Tests at 225°C with

moist air have shown first bed loadings of 141.5 mg CH₃I per gram of AgZ at breakthrough of the last bed. Higher loadings could possibly be achieved since, in both cases, the first bed was not saturated under the given conditions.

Improved loading was also observed in a run that was stopped at breakthrough, that is, a DF < 1000, which was allowed to remain at its operating temperature (150°C) overnight. When loading was reinitiated 18 h later, the DF across the bed remained above 1000 for 2 h, allowing the additional loading of ~20 mg/g on the first bed before breakthrough occurred again. During the heat soaking period, the iodine apparently distributed into the AgZ pellet thus freeing some of the more accessible silver sites for the second loading period. The elevated temperatures probably facilitate similar movement of the iodine into the more inaccessible silver sites, thus increasing the overall silver utilization.

3.2 Regeneration Test of AgZ

Loaded AgZ beds were regenerated with the equipment shown in Fig. 4, using both 4.5% H₂–95.5% Ar and pure H₂. Both gas streams satisfactorily remove the chemisorbed iodine. The assumed reaction is:

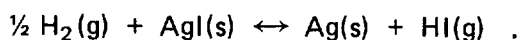

Equilibrium vapor pressures of HI at an operating temperature of 500°C are 26.5 and 119.1 Pa for 5 and 100% H₂ respectively.

ORNL DWG. 80-15053

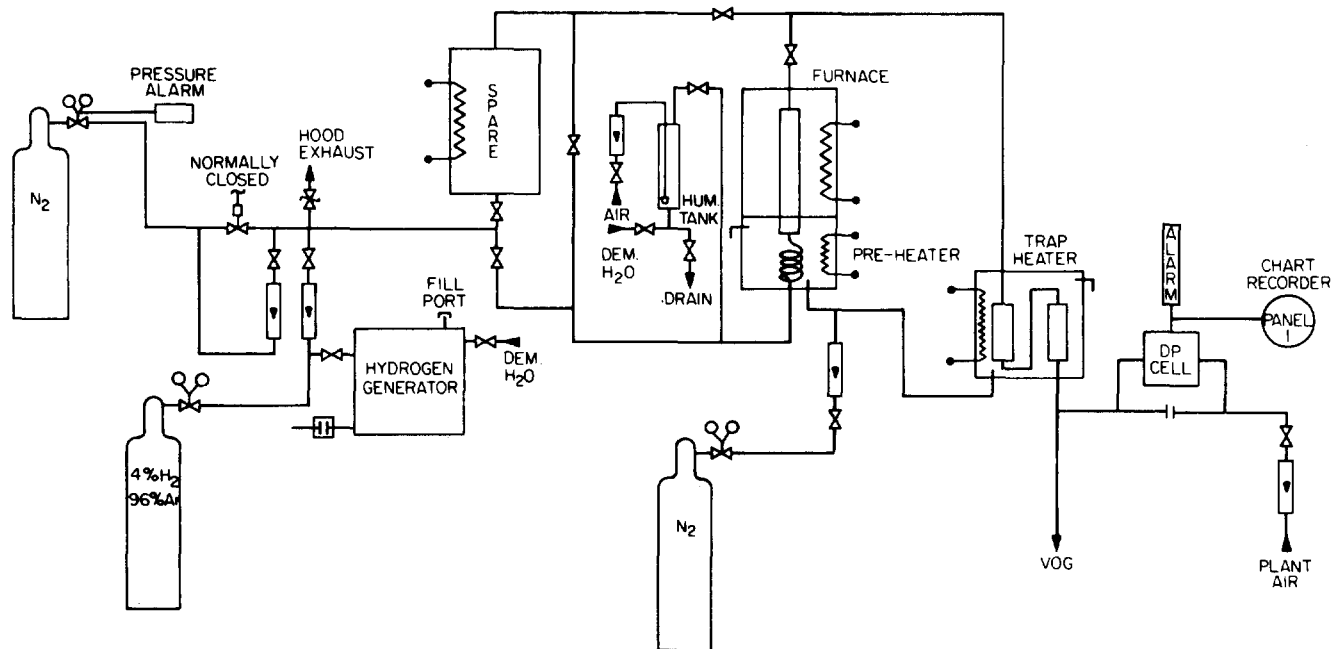

Fig. 4. Hydrogen regeneration flowsheet for silver mordenite.

The hydrogen flow was countercurrent to the original iodine flow. The iodine in the form of HI was then trapped on the PbX bed. During 24 h of regeneration with an H₂ flow of 0.5 SLPM,* >50% of the I₂ is removed in 6 h and >98% in 24 h. The second loading of the regenerated bed using the same feed conditions as the initial loading resulted in significantly lower loadings than the original loading. The addition of water vapor to the feed gas improved loads to approximately one-third of the original loadings at 150°C.⁵ This loading is significantly lower than the post-regeneration loadings reported by Thomas et al.⁴

*Standard liters per minute.

An examination of the AgZ by x-ray diffraction and scanning electron microscopy showed:

1. the presence of free silver following 4.5% H₂ pretreatment at 200°C,
2. the formation of small (<2000 Å) nodules of silver during 4.5% H₂ at 200°C pretreatment,
3. no free silver or silver nodules on air-pretreated AgZ, and
4. large (>8000 Å) nodules of silver following regeneration at 500°C with 4.5% H₂.

To determine the effects of temperature and time on the formation of the silver nodules and subsequent CH₃I loading on the AgZ, a series of beds was treated with 100% H₂ for 24 or 48 h at temperatures of 200, 400, or 500°C. Following this treatment, the beds were loaded with CH₃I in dry air. The results of the bed loadings are shown in Table 1.

Table 1. CH₃I loadings of 100% hydrogen-treated AgZ in dry air

| Run | Temperature (°C) | Time (h) | Loading (mg/g) |
|-----|------------------|----------|----------------|
| 57 | 200 | 24 | 35.6 |
| 58 | 200 | 48 | 12.3 |
| 59 | 400 | 24 | 11.0 |
| 61 | 400 | 48 | 8.0 |
| 60 | 500 | 48 | 0.26 |

Loadings showed decreased retention capacity for CH₃I as exposure time to H₂ increased and as temperature of exposure increased. Photomicrographs showed small increases in the nodule size from 200 to 400°C and a significant increase in nodule size at 500°C. It is the migration of the silver to these nodules that is believed to (at least partially) account for the decrease in CH₃I loadings. The migration of silver in the presence of hydrogen was also noted by Yates in 1965.⁶ Yates reported that silver crystallites of 170 Å formed in the presence of H₂ at 250°C. These temperatures of interest are well below the melting point of silver (961°C). The vapor pressure of silver is correspondingly low (10⁻⁵-mm Hg at 757°C).

Work by Scheele et al.⁷ using glass housings for the AgZ did not show the same large nodules following a hydrogen pretreatment at 500°C nor was the loading as low. A series of tests was conducted using a 5.08-cm-diam glass column to explore the possible effects of filter housing material. AgZ was placed in this column and treated with 100% H₂ at 500°C for 24 h. The bed was then loaded with CH₃I to 54 mg/g at 200°C in moist air. This is approximately half the loading observed for AgZ under the same loading conditions but treated with 4.5% H₂ at 200°C and 10 times higher than loadings following hydrogen treatment at 500°C in stainless steel.

Beyer and Jacobs⁸ have also reported on the roles temperature and iron impurities play in the hydrogen reduction and reoxidation of AgZ. At increasing reduction temperatures, the intensity of the (111) diffraction of crystalline silver external to the zeolite increases and the particle size of the silver crystallites also increases. They also report that upon oxidation at sufficiently high temperatures, the external silver phase disappears. After a second redox cycle at 653 K, a small amount of the silver remains located between the zeolite crystallites, indicating a slight irreversibility of the system.

The proposed stoichiometry appears straightforward for both reduction and oxidation:

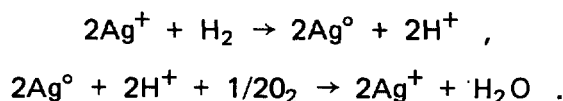

A second, and possibly clearer, representation of the reduction reaction showing the role of the mordenite is given by Tszuri and Takahashi:⁹

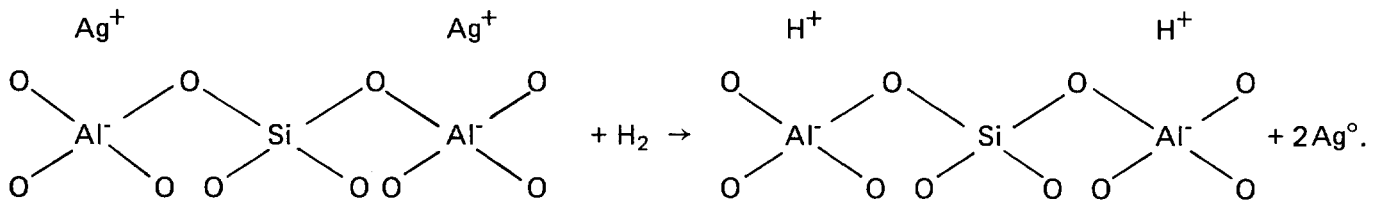

Beyer and Jacobs also indicated that the reduction is a catalyzed process where hydrogen is probably activated on iron impurities within the zeolite structure of the material they used. It was shown that rate of reduction strongly depends on the iron content. In fact, using partially deironized material, the rate of reduction of silver ions showed a fivefold decrease, whereas the reduction mechanism remained unchanged as deduced from the slope of the Arrhenius plots.

This "activation" of the hydrogen by iron would account for the rapid formation of large silver nodules when treating AgZ in the stainless steel housing at high temperatures and the much slower formation of nodules in the glass housing. These reactions must be taken into account when designing actual plant off-gas systems using silver zeolites since it appears that only a very limited amount of CH₃I can be adsorbed onto AgZ in which the silver has formed large metal agglomerates.

3.3 Scoping Tests on Partially Exchanged Silver Mordenite

Tests on fully exchanged AgZ indicate the iodine probably first chemisorbs at the easily accessible silver sites. Experience in exchanging the sodium for silver has also shown that the last 25% of the exchange is more difficult to accomplish. With this in mind, the CH₃I loading characteristics of partially exchanged silver mordenite (LA₀AgZ) were examined using a fractional factorial designed experiment. The experiment examined the effects of NO, NO₂, humidity, bed temperature, dilute hydrogen, and silver content on the loading capacity. The dilute hydrogen stream was added in an attempt to maintain the silver in the reduced state during the loading phase. Although hydrogen was also used for regeneration of the loaded AgZ beds, the loading operation was conducted at a significantly lower temperature than the regeneration step. Experimental conditions are presented in Table 2. The eight-run design, along with the loading on the first bed, and the effects of each variable are shown in Tables 3 through 7.

Response errors for a designed experiment can be estimated using the dummy variable.¹⁰ Using this technique, values of 2.16, 6.86, 3.98, 0.14, and 1.96 mg/g were obtained for Tables 3 through 7 respectively. However, this method probably overestimates the response errors since some degree of interaction between the measured variables is likely. A response error has also been calculated using replicate runs. This method indicates the response error to be on the order of 0.5 mg/g. The response error is, however, controlled somewhat by how closely breakthrough can be determined and how quickly the run can be stopped. If the entire mass transfer zone is contained within the test beds, then the effect of not stopping the run at the exact moment of breakthrough is not critical since the first bed is no longer playing an active role in iodine removal. Under certain conditions, the mass transfer zone becomes longer than the 15-cm bed length. The first bed is therefore still loading at the time of shutdown, hence more variation in its loading would be expected.

Analysis of the scoping studies indicated that:

1. Increased CH₃I loadings occur with increasing silver content. This increase in loading appears to stabilize above the 3% Ag content.

17th DOE NUCLEAR AIR CLEANING CONFERENCE

2. An operating temperature of 200°C is favored over either 150 or 250°C. The difference between 200°C loadings and 250°C loadings appears to decrease as the silver content increases. This corresponds to the bed loading versus temperature response observed for the fully exchanged material.
3. NO and NO₂ produced small and varied positive and negative effects.
4. The effects of water vapor also produced mixed results.
5. The addition of 1 vol % hydrogen to the inlet stream resulted in increased bed loadings at the lower silver contents. This is probably the result of maintaining more of the limited amount of silver in the reduced state.

Table 2. Experimental conditions for scoping studies

| Variable | Value |
|--|---------------------------------------|
| Bed weight, g | ~40 |
| Bed diameter, cm | 5.08 |
| Bed thickness, cm | 2.54 |
| Number of beds | 6 |
| Carrier gas | Air |
| Superficial velocity, m/min at STP | 10.0 |
| CH ₃ I concentration mg/m ³ at STP | 1000 |
| NO concentration, % | 0 or 3.0 |
| NO ₂ concentration, % | 0 or 3.0 |
| Relative humidity (dewpoint), °C | -54 or ~35 |
| Pretreatment | 4.5% H ₂ in argon for 24 h |
| Bed temperature, °C | 150, 200, or 250 |
| Hydrogen, % | 0 or 1.0 |
| Silver content, wt % | 1.5, 3.0, 5.0, or 9.0 |

Table 3. Summary of screening runs for 1.5–3.0% LAgZ^a

| Run | Bed 1 loading ^b (mg/g) | NO | NO ₂ | Dew point (°C) | Temperature ^c | Ag (wt %) in AgZ | 4% H ₂ | Dummy |
|--------|-----------------------------------|--------|-----------------|----------------|--------------------------|------------------|-------------------|--------|
| 1 | 17.74 | - | - | - | - | - | - | + |
| 2 | 21.63 | + | - | - | + | + | - | - |
| 3 | 11.13 | - | + | - | + | - | + | - |
| 4 | 30.10 | + | + | - | - | + | + | + |
| 5 | 37.44 | - | - | + | - | + | + | - |
| 6 | 7.48 | + | - | + | + | - | + | - |
| 7 | 22.95 | - | + | + | + | + | - | + |
| 8 | 14.18 | + | + | + | - | - | - | - |
| | | --=0 % | --=0% | --=-54°C | --=200°C | --=1.5% Ag | --=0 LPM | |
| | | + =3% | + =3% | + = 35°C | + =250°C | + =3.0% Ag | + =5 LPM | |
| Effect | | -3.968 | -1.483 | 0.363 | -9.068 | 15.398 | 2.413 | -1.528 |

^a Run conditions: six beds each, 2.54-cm-thick, 5.08 cm in diameter, gas rate 20 SLPM; pretreated 24 h at 200°C with dry 4.5% H₂-95.5% Ar; average decontamination factor >10³.

^b Loadings are based on a dry density of 0.78 g/cm.

^c Bed temperature.

17th DOE NUCLEAR AIR CLEANING CONFERENCE

Table 4. Summary of screening runs for 1.5–3.0% LAgZ^a

| Run | Bed 1 loading ^b (mg/g) | NO | NO ₂ | Dew point (°C) | Temperature ^c | Ag (wt %) in AgZ | 4% H ₂ | Dummy |
|--------|-----------------------------------|--------|-----------------|----------------|--------------------------|------------------|-------------------|--------|
| 1 | 17.74 | – | – | – | – | – | – | + |
| 2 | 26.05 | + | – | – | + | + | – | – |
| 3 | 16.23 | – | + | – | + | – | + | – |
| 4 | 30.10 | + | + | – | – | + | + | + |
| 5 | 37.44 | – | – | + | – | + | + | – |
| 6 | 10.04 | + | – | + | + | – | + | + |
| 7 | 16.32 | – | + | + | + | + | – | + |
| 8 | 14.18 | + | + | + | – | – | – | – |
| | | –=0 % | –=0% | –=–54°C | –=200°C | –=1.5% Ag | –=0 LPM | |
| | | + =3% | + =3% | + = 35°C | + =150°C | + =3.0% Ag | + =5 LPM | |
| Effect | | –1.840 | –3.610 | –3.035 | –7.705 | 12.930 | 4.880 | –4.925 |

^a Run conditions: six beds each, 2.54-cm-thick, 5.08 cm in diameter, gas rate 20 SLPM; pretreated 24 h at 200°C with dry 4.5% H₂–95.5% Ar; average decontamination factor >10³.

^b Loadings are based on a dry density of 0.78 g/cm.

^c Bed temperature.

Table 5. Summary of screening runs for 3.0–5.0% LAgZ^a

| Run | Bed 1 loading ^b (mg/g) | NO | NO ₂ | Dew point (°C) | Temperature ^c | Ag (wt %) in AgZ | 4% H ₂ | Dummy |
|--------|-----------------------------------|-------|-----------------|----------------|--------------------------|------------------|-------------------|--------|
| 1 | 21.48 | – | – | – | – | – | – | + |
| 2 | 21.63 | + | – | – | + | + | – | – |
| 3 | 20.99 | – | + | – | + | – | + | – |
| 4 | 30.10 | + | + | – | – | + | + | + |
| 5 | 37.44 | – | – | + | – | + | + | – |
| 6 | 23.60 | + | – | + | + | – | + | + |
| 7 | 22.95 | – | + | + | + | + | – | + |
| 8 | 29.33 | + | + | + | – | – | – | – |
| | | –=0 % | –=0% | –=–54°C | –=200°C | –=5.0% Ag | –=0 LPM | |
| | | + =3% | + =3% | + = 35°C | + =250°C | + =3.0% Ag | + =5 LPM | |
| Effect | | 0.450 | 0.195 | 4.780 | –7.295 | 4.180 | 4.185 | –2.815 |

^a Run conditions: six beds each, 2.54-cm-thick, 5.08 cm in diameter, gas rate 20 SLPM; pretreated 24 h at 200°C with dry 4.5% H₂–95.5% Ar; average decontamination factor >10³.

^b Loadings are based on a dry density of 0.78 g/cm.

^c Bed temperature.

17th DOE NUCLEAR AIR CLEANING CONFERENCE

Table 6. Summary of screening runs for 1.5–9% LA_gZ^a

| Run | Bed 1 loading ^b (mg/g) | NO | NO ₂ | Dew point (°C) | Temperature ^c | Ag (wt %) in AgZ | 4% H ₂ | Dummy |
|--------|-----------------------------------|-------|-----------------|----------------|--------------------------|------------------|-------------------|-------|
| 1 | 21.48 | – | – | – | – | – | – | + |
| 2 | 28.45 | + | – | – | + | + | – | – |
| 3 | 20.99 | – | + | – | + | – | + | – |
| 4 | 27.60 | + | + | – | – | + | + | + |
| 5 | 22.51 | – | – | + | – | + | + | – |
| 6 | 23.60 | + | – | + | + | – | + | + |
| 7 | 28.99 | – | + | + | + | + | – | + |
| 8 | 29.33 | + | + | + | – | – | – | – |
| | | –=0 % | –=0% | –=–54° C | –=200° C | –=1.5% Ag | –=0 LPM | |
| | | + =3% | + =3% | + = 35° C | + =250° C | + =9.0% Ag | + =5 LPM | |
| Effect | | 0.665 | 1.450 | –2.940 | –1.495 | 14.255 | –5.160 | 1.385 |

^aRun conditions: six beds each, 2.54-cm-thick, 5.08 cm in diameter, gas rate 20 SLPM; pretreated 24 h at 200°C with dry 4.5% H₂–95.5% Ar; average decontamination factor >10³.

^bLoadings are based on a dry density of 0.78 g/cm.

^cBed temperature.

Table 7. Summary of screening runs for 5–9% LA_gZ^a

| Run | Bed 1 loading ^b (mg/g) | NO | NO ₂ | Dew point (°C) | Temperature ^c | Ag (wt %) in AgZ | 4% H ₂ | Dummy |
|--------|-----------------------------------|-------|-----------------|----------------|--------------------------|------------------|-------------------|-------|
| 1 | 17.74 | – | – | – | – | – | – | + |
| 2 | 28.45 | + | – | – | + | + | – | – |
| 3 | 11.13 | – | + | – | + | – | + | – |
| 4 | 27.60 | + | + | – | – | + | + | + |
| 5 | 22.51 | – | – | + | – | + | + | – |
| 6 | 7.48 | + | – | + | + | – | + | + |
| 7 | 28.99 | – | + | + | + | + | – | + |
| 8 | 14.18 | + | + | + | – | – | – | – |
| | | –=0 % | –=0% | –=–54° C | –=200° C | –=5.0% Ag | –=0 LPM | |
| | | + =3% | + =3% | + = 35° C | + =250° C | + =9.0% Ag | + =5 LPM | |
| Effect | | 3.752 | 2.717 | 1.477 | 0.278 | 3.038 | –3.388 | 0.097 |

^aRun conditions: six beds each, 2.54-cm-thick, 5.08 cm in diameter, gas rate 20 SLPM; pretreated 24 h at 200°C with dry 4.5% H₂–95.5% Ar; average decontamination factor >10³.

^bLoadings are based on a dry density of 0.78 g/cm.

^cBed temperature.

Silver utilization averaged 72% for both 1.5 and the 3% LA $\overset{\circ}{\text{g}}$ Z, whereas silver utilizations of over 50% were rare with AgZ; the highest silver utilization on AgZ seen to date is 64%. One hundred percent silver utilization on three percent LA $\overset{\circ}{\text{g}}$ Z was seen in run 5 of the first LAgZ scoping study (Table 3).

For both 5 and 9% LAgZ, the silver utilization and the associated CH₃I appears low. The maximum silver utilization for the 9% LAgZ was 27%. This may be the result of a changing batch of sodium mordenite. In the period between the two purchases of NaZ, the Norton Company changed production sites of the Zeolon-900 from Stow, Ohio to Brian, Texas.¹¹ An effort to determine the difference in the process and/or material used has been undertaken by both Norton and ORNL. This change in base material could have an impact on future solid sorbent work. Should the difference result from impurities in the water used in processing, treatment steps could be taken to produce material of similar quality to that obtained from the Ohio plant. On the other hand, if the difference occurs as a result of using locally available raw materials, it may be much more difficult, if not impossible, to produce the same product as before. An initial response from Norton indicated that the new NaZ was from the first batch of product from the Texas plant and may not have been properly washed prior to final firing thus leaving impurities inside the mordenite pellet.

Similar problems were encountered by Holland et al.¹¹ with 3A molecular sieves from Linde. In this case, an eightfold change in iodine retention apparently resulted from a change in the binder.

Prior to the 5 and 9% scoping studies, several intermediate silver loading studies were conducted using the early batch of substrate. Silver loadings of 12 wt % yielded CH₃I loadings between 86 and 118 mg of CH₃I per gram AgZ depending on the run conditions. These loadings correspond to silver utilizations of 61 to 84%. In addition to this evidence, two batches of 3% Ag made from the new NaZ have consistently produced CH₃I loadings and silver utilization of approximately half the loadings and silver utilizations observed for the four batches of 3% AgZ made from original NaZ.

3.4 Regeneration of LAgZ

Regeneration studies of the LA $\overset{\circ}{\text{g}}$ Z indicate that the use of 4.5% H₂ in argon at 500°C does not perform in the same manner as it does with fully exchanged silver mordenite. Very little (<5% in 24 h) of the iodine loaded onto the LA $\overset{\circ}{\text{g}}$ Z is removed by the 4.5% H₂ treatment at temperatures up to 500°C, and only limited iodine removal (~13%) was achieved using pure hydrogen at 500°C for 48 h. Although air purges at temperatures up to 250°C are also ineffective for removing iodine, air at 500°C will remove >90% of the iodine in 24 h. The regenerated material has been reloaded with CH₃I to ~90% of the original iodine loading and regenerated three times with similar results. During the air regenerations at 500°C, 30 to 40% of the iodine is removed in the first hour and an additional 30 to 35% is removed during the second hour of regeneration.

Additional tests of LA $\overset{\circ}{\text{g}}$ Z regeneration were conducted using pure O₂ at 500°C and pure N₂ at 500°C. In both tests <1% of the iodine loaded on the bed was removed by the pure gas stream. Use of a combined 20% O₂–80% N₂ gas stream produced results similar to those observed for an air stream. The negative response for either pure stream indicates a probable reaction between the O₂ and N₂, possibly forming an NO_x. However, this behavior is not fully understood and is currently under investigation.

A second unexplained, but possibly useful, phenomenon was the inability to remove the iodine from the loaded LA $\overset{\circ}{\text{g}}$ Z beds with hydrogen. It is suspected that the hydrogen gas stream may facilitate a transfer of iodine from silver sites to sodium sites within the pellets. Similar removal, or lack of removal, characteristics were noted by Thomas¹² using a mixed bed of AgZ and NaZ. During the regeneration mode, the iodine was not removed from the bed with hydrogen at 500°C as had been demonstrated for AgZ beds. Interpellet iodine transfer for LA $\overset{\circ}{\text{g}}$ Z was examined during four transfer and reloading cycles. A cycle consists of the transfer of iodine from one site within the pellet to another by passing a 4.5% H₂ stream across the beds.

17th DOE NUCLEAR AIR CLEANING CONFERENCE

This was tried, followed by a reloading of CH_3I onto the beds until breakthrough occurred. The total bed loadings for each step in the four cycles are shown in Table 8. This procedure appears to allow at least a doubling in iodine capacity on the bed.

**Table 8. Total bed loadings during interpellet iodine transfer studies
loading on bed in mg CH_3I /g LAgZ**

| Cycle | Bed number | | | | | |
|-----------------|------------|------|------|------|------|-------|
| | 1 | 2 | 3 | 4 | 5 | 6 |
| Initial loading | 37.4 | 37.2 | 22.7 | 11.5 | 1.90 | 0.03 |
| 1st transfer | 23.6 | 22.4 | 22.0 | 11.0 | 2.36 | 0.048 |
| 2nd loading | 37.7 | 41.7 | 42.4 | 10.1 | 14.8 | 6.99 |
| 2nd transfer | 26.9 | 22.6 | 23.5 | 23.8 | 5.42 | 8.08 |
| 3rd loading | 44.3 | 42.0 | 41.8 | 39.6 | 28.8 | 10.8 |
| 3rd transfer | 32.7 | 24.0 | 28.2 | 22.2 | 25.2 | 21.3 |
| 4th loading | 43.0 | 35.1 | 37.9 | 32.7 | 24.8 | 23.7 |
| 4th transfer | 43.7 | 33.4 | 21.0 | 25.5 | 19.0 | 22.1 |
| 5th loading | 58.9 | 51.7 | 35.6 | 33.8 | 21.0 | 23.1 |

3.5 LAgZ Potential as Main Filter Material

The high degree of silver utilization achieved by LAgZ makes this material attractive for use in a main filter. Of concern during early studies was the high cost associated with the use of silver-substituted zeolites; however, the cost associated with LAgZ is quite low. For example, assuming the following: (1) 3% silver loading by weight; (2) 95% silver utilization; (3) \$10 per troy oz. of silver (\$6.70 per troy oz. of silver on May 21, 1982); and (4) \$11 per kg for 1/16-in.-diam Norton Zeolon 900, a 0.5-t/d nuclear fuel reprocessing plant would require 7.5 kg/d of sorbent to remove the 0.25 kg/d of halogens present in the plant off-gas. The cost of the sorbent amounts to ~\$82 for the substrate and \$76 for silver per day or a total cost of \$6.60/h of operation. The total volume of waste generated would be approximately 0.01 m³/d.

Future work with the partially exchanged silver mordenites will be directed to optimize the degree of silver loading to reduce the total cost and more importantly, the waste volume. The use of interpellet iodine transfer may also play a role in reducing the waste volume.

4. Conclusions

The following conclusions can be made from the experimental results and interpretation of the data:

1. Loadings of ~142 mg of CH_3I per g of AgZ can be obtained. This represents a silver utilization of ~60%.
2. Increased bed temperature has a positive effect on the loading capacity of the AgZ and AgZ.
3. Water vapor content up to a dewpoint of 35°C has a positive effect on the CH_3I loadings on AgZ.
4. Nodules of free silver are formed in AgZ during hydrogen exposure. The size of the nodule appears to be a function of the temperature more than the exposure time. Nodules ~2000 Å in diameter are formed in beds up to 400°C. At 500°C, nodules 10 to 20 times as large are formed.
5. CH_3I loading decreases with hydrogen exposure at increasing temperature.

17th DOE NUCLEAR AIR CLEANING CONFERENCE

6. Higher loadings are achieved using glass filter housings than when using stainless steel when high temperature hydrogen for regeneration is employed.
7. Iron plays a key role in the migration of silver in the mordenite.
8. High silver utilizations (>95%) can be achieved for LA $\overset{\circ}{\text{g}}\text{Z}$.
9. A bed temperature of 200°C produces higher CH₃I loadings on LA $\overset{\circ}{\text{g}}\text{Z}$ than temperatures of 150 or 250°C.
10. LA $\overset{\circ}{\text{g}}\text{Z}$ cannot be regenerated using hydrogen at 500°C as can A $\overset{\circ}{\text{g}}\text{Z}$.
11. Interpellet iodine transfer can be used to extend LA $\overset{\circ}{\text{g}}\text{Z}$ capacity.
12. Air at 500°C can strip iodine from LA $\overset{\circ}{\text{g}}\text{Z}$.
13. LA $\overset{\circ}{\text{g}}\text{Z}$ produced from newly acquired NaZ resulted in lower iodine capacity. This may be the result of incomplete washing of the NaZ prior to final firing at the manufacture.

Future plans include:

1. Further examine the effects of stainless steel on A $\overset{\circ}{\text{g}}\text{Z}$ regeneration and nodule formation.
2. Examine the effect of operating conditions on the length of the mass transfer zone.
3. Determine the optimum silver loading on A $\overset{\circ}{\text{g}}\text{Z}$ to minimize waste volume and maximize silver utilization.
4. Investigate the mechanisms involved in CH₃I loads on A $\overset{\circ}{\text{g}}\text{Z}$ and LA $\overset{\circ}{\text{g}}\text{Z}$.
5. Study mixed I₂ and CH₃I loadings on LA $\overset{\circ}{\text{g}}\text{Z}$.
6. Determine differences between the two batches of NaZ.
7. Explore air stripping mechanisms for LA $\overset{\circ}{\text{g}}\text{Z}$.
8. Examine interpellet transfer in LA $\overset{\circ}{\text{g}}\text{Z}$.

5. References

1. D. T. Pence and B. A. Staples, "Solid adsorbents for collection and storage of iodine-129 from reprocessing plants," *Proc. 13th AEC Air Cleaning Conf.*, CONF-740807, p. 758 (August 1974).
2. L. L. Burger, "Storage of unprocessed fuel," *Nuclear Waste Management Quarterly Progress Report April Through June 1977*, ed. by A. M. Platt, Pacific Northwest Laboratories, BNWL-2377-2 (November 1977).
3. B. A. Staples, L. P. Murphy, and T. R. Thomas, "Airborne elemental iodine loading capacities of metal zeolites and a dry method for recycling silver zeolite," *Proc. 14th ERDA Air Cleaning Conf.*, CONF-760822, p. 363 (August 1976).
4. T. R. Thomas, B. A. Staples, and L. P. Murphy, "The development of A $\overset{\circ}{\text{g}}\text{Z}$ for bulk ¹²⁹I removal from nuclear fuel reprocessing plants and PbX for ¹²⁹I storage," *Proc. 15th DOE Air Cleaning Conf.*, CONF-780819, p. 394 (August 1978).
5. R. T. Jubin, "Organic iodine removal from simulated dissolver off-gas streams using silver-exchanged mordenite," *Proc. 16th DOE Air Cleaning Conf.*, CONF-801038, p. 519 (October 1980).
6. D. J. C. Yates, "The stability of metallic cations in zeolites," *J. Phys. Chem.* **69**, 1676 (1965).
7. L. L. Burger, "Iodine-129 fixation," *Nuclear Waste Management Quarterly Progress Report April Through June 1981*, ed. by Judy Powell, Pacific Northwest Laboratories (in publication).

17th DOE NUCLEAR AIR CLEANING CONFERENCE

8. H. K. Beyer and P. A. Jacobs, "Reduction and Reoxidation of Silver Mordenites," *Molecular Sieves-II*, ed. by James R. Katzer, ACS Symposium Series No. 40, American Chemical Society, Washington, D.C. (1977).
9. K. Tsutsumi and H. Takahashi, "The formation of metallic silver in silver form zeolites," *Bull. Chem. Soc. Jpn.* 45(8), 2332-2337 (1977).
10. T. D. Murphy, Jr., "Design and analysis of industrial experiments," *Chem. Eng.* 84, 168-82 (1977).
11. B. Horan, Norton Chemical Process Products Division, Akron, Ohio, personal communication.
12. W. D. Holland, A. H. Shaw, A. F. Kaiser, J. C. McGee, *Experimental Studies Concerning the Drying of Voloxidizer Off-Gases*, ORNL/Sub-7164/1 (July 1981).
13. T. R. Thomas, personal communication.

DISCUSSION

VIKIS: How do you rationalize your observation that air releases the sorbed iodine at 500°C, but N₂ or O₂ individually would not? What happens to the organic part of CH₃I, does it stay on the sorbent or does it go through?

JUBIN: We currently suspect the formation of small quantities of NO_x from the N₂ and O₂ as the gas stream passes across the silver mordenite bed. We have been able to strip the loaded iodine from the bed using streams of NO or NO₂. The formation of NO_x is presently under investigation at ORNL. The organic portion passes through the bed.

PORREY: Do you intend to investigate the differences in early and later base mordenite material? What does Norton believe is the problem? Have x-ray diffraction studies been done to determine differences?

JUBIN: We are presently investigating the differences between the two batches of sodium zeolite. No significant differences were observed using x-ray diffraction. A quantitative analysis of both batches also showed no major differences in the major and minor components. Norton believes the problem lies with inadequate washing of the zeolite prior to its final firing. This resulted in some additional material being trapped within the micro- and macropore structure. This possibility is supported by a pore size distribution measurement of both batches which showed a reduced pore size in the material from the Brian, TX facility.

THOMAS, T.R.: Are you getting better CH₃I loading capacities with Ag₂Z or Ag⁰Z (pretreated with H₂)? Is it the Fe⁰ impurities in the Ag⁰Z or the Fe⁰ from the S.S. reactor that is responsible for low CH₃I loadings after regeneration?

JUBIN: We get better loading capacities for CH₃I using Ag⁰Z (pretreated with H₂ at 200°C for 24 hours). Loading capacities drop as time and, more critically, temperature is increased. We believe the major factor is the Fe⁰ in the reactor vessel itself since only small losses in capacity are noted following regeneration in a glass housing.

17th DOE NUCLEAR AIR CLEANING CONFERENCE

THOMAS, T.R.: From your paper, I estimate it would cost about \$700,000/yr. (based on 300 days) for the AgOZ (3% - 5% by wt exchanged) for a 5t/d FRP. Is that correct?

JUBIN: Yes, assuming a throwaway bed. However, over half of the cost is the substrate itself. If higher silver loadings perform as well as the 3% LAgZ, the total cost and waste volume can be reduced by 25% and 50% by using 6% LAgZ. The performance characterization of the 5-6 LAgZ and 9% LAgZ will be completed as soon as the problems encountered with the new NaZ are resolved.

A PARAMETRIC STUDY ON REMOVAL EFFICIENCY OF
IMPREGNATED ACTIVATED CHARCOAL AND SILVER ZEOLITE
FOR RADIOACTIVE METHYL IODIDE

H. Shiomi, Y. Yuasa and A. Tani
Nippon Atomic Industry Group Co., Ltd.
Kawasaki, Japan

M. Ohki and T. Nakagawa
Toshiba Corporation
Yokohama, Japan

The Tokyo Electric Power Co., Inc.
The Tohoku Electric Power Co., Inc.
The Chubu Electric Power Co., Inc.
The Hokuriku Electric Power Co., Inc.
The Chugoku Electric Power Co., Inc.
The Japan Atomic Power Co., Ltd.

Abstract

The removal efficiency of impregnated activated charcoal and silver zeolite for radioactive methyl iodide is influenced by various parameters such as temperature, relative humidity, face velocity and packing density. This study is to evaluate the dependency of the removal efficiency on each parameter and these combined parameters, quantitatively. Four types of adsorbents, BC-727, AgX, CHC-50 and SS 208C 5KI₃, were tested. From experimental data and mass transfer theory, an experimental equation for evaluating the removal efficiency of adsorbents was derived under a series of experiments for radioactive methyl iodide-131. It was concluded that the removal efficiency calculated from the experimental equation agreed well with the experimental value. Effects of experimental specific parameters, such as Pre-flow time, methyl iodide injection time and After-flow time, on the removal efficiency of adsorbent are also described.

I. Introduction

Impregnated activated charcoal and silver zeolite are being utilized at Nuclear Power Facility and Radioactive Isotope Facility, in order to remove radioactive iodine from gaseous effluents of those facilities. The trapping efficiency of these adsorbents for radioactive iodine is affected by such parameters as bed length, packing density, temperature, relative humidity and face velocity. The dependency of the trapping efficiency on each parameter is important to design a radioactive iodine removal system and to evaluate reliability of the system under accident conditions.

Influence of individual parameters has been reported^{(1), (2), (3)}, but the quantitative evaluation on influence of these combined parameters has hardly been discussed. It is desirable, however, to evaluate quantitatively the influence of combined parameters from above mentioned reasons. From the point of view, authors have tried to conduct a series of experiments in order to derive and check an experimental equation which can evaluate the influence of combined

parameters.

II. Experimental

Apparatus and Experimental Procedure. The experimental apparatus consisted of methyl iodide generator, humidifier and adsorbent bed installed in a thermostated oven as shown in Figure 1. Figure 2 shows the construction of the bed and the stainless steel filter elements which were assembled into the bed. The filter element have internal dimensions of 60mm diameter by 10mm long and both sides are covered with a stainless steel screen 50mm in diameter. Each filter element was packed with the adsorbents shown in Table I.

Table I. Impregnated Adsorbents under Investigation

| Adsorbents | Base Material | Nominal Size | Apparent Density | Impregnation |
|---------------------------------|------------------------|--------------|-----------------------|----------------------------|
| BC-727 | Coconut | 8 x 16 | 0.50g/cm ³ | KI+I ₂ , 5 w/o |
| AgX* | Molecular Sieve Type X | 10 x 16 | 1.1 g/cm ³ | Ag(Exchanged metal cation) |
| CHC-50** | Coconut | 28 x 60 | 0.60g/cm ³ | TEDA, 10 w/o |
| SS 208C 5KI ₃ *** | Coconut | 8 x 16 | 0.50g/cm ³ | KI+I ₂ , 5 w/o |

* CTI-NUCLEAR silver zeolite, Type III

** Toyo Roshi (Toyo Filter Paper) Co., Ltd.

*** Sutcliffe Speakman & Co., Ltd.

The experiments were conducted according to the order of pre-flow step, methyl iodide injection step and after-flow step.

Pre-flow step: Air with controlled relative humidity was run through the bed until the adsorbents reached equilibrium. The Ueshima-Brooks mass flowmeter measured and controlled flow rate of dry air. The mass flowmeter has a rated accuracy of ± 2 percent. Relative humidity can be controlled in the range of 0 ~ 95 percent with accuracy of ± 1 percent and temperature of the adsorbent bed in the thermostated oven can be controlled in the range of 20 ~ 90°C within $\pm 0.5^\circ\text{C}$.

Methyl iodide injection step: After the pre-flow step, Nitrogen gas which contained methyl iodide tagged with ¹³¹I was being injected into humid air flow during from 0.25 hours to 2 hours. The injection flow rate was monitored with a NaI(Tl) scintillation detector.

After-flow step: Following the methyl iodide injection step, humid air was passed through the bed at the same condition as in the pre-flow step for 0.1 ~ 15 hours.

After these steps, the piping and the bed were swept with dry air, and then the bed was disassembled to the filter elements. Radioactivity collected in each filter element was measured with a

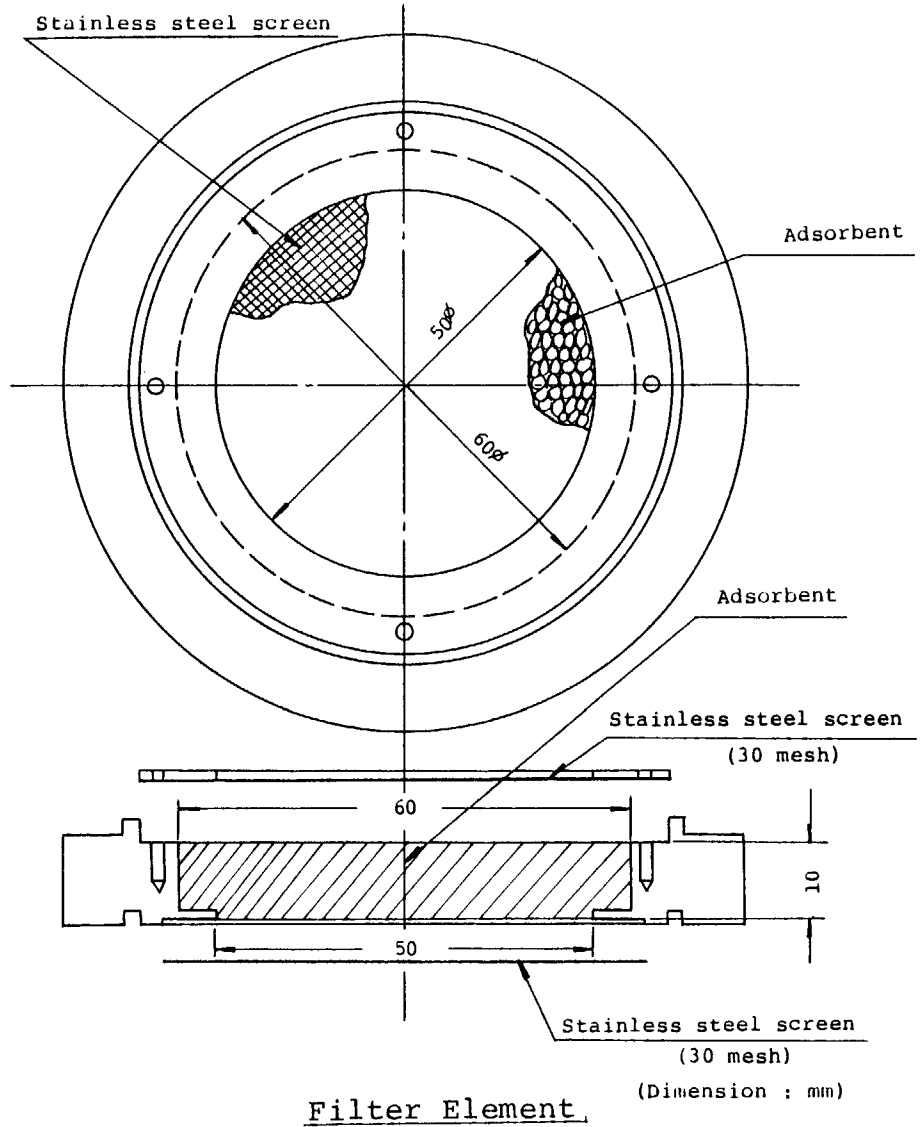
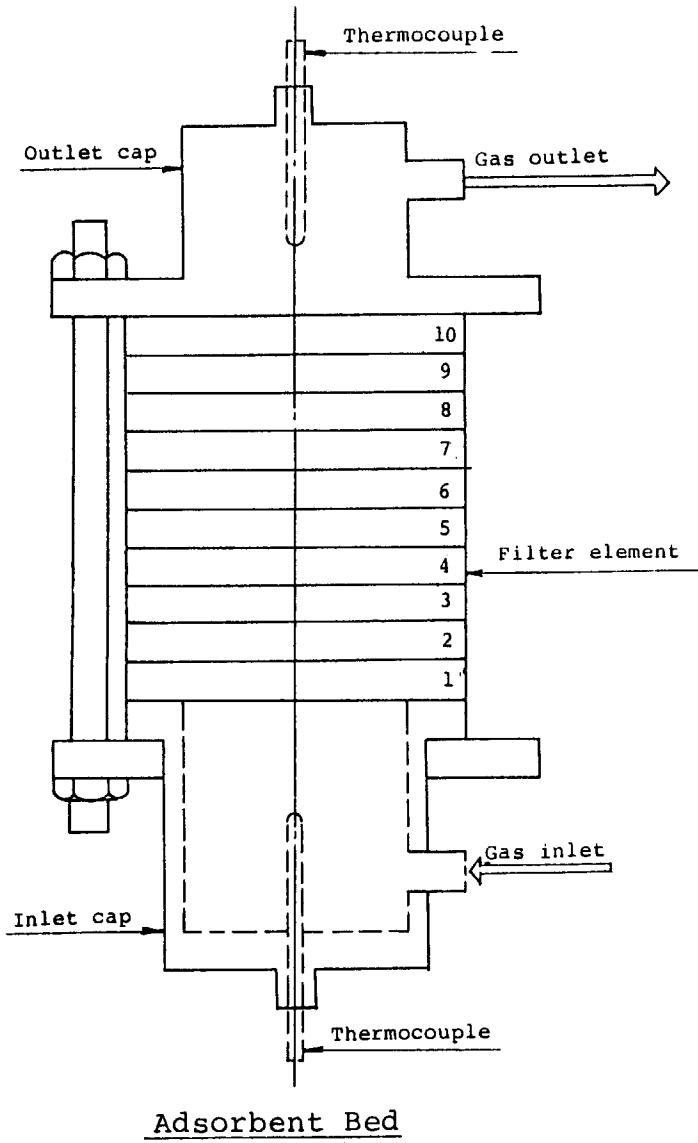

Fig.2 Filter Element and Filter Bed Assembly

Ge(Li) detector.

Experimental Conditions. Table I shows the properties of adsorbents which were used in experiment. Removal efficiency of the adsorbents for methyl iodide-131 is affected by such parameters as temperature, relative humidity, face velocity, packing density, pre-flow time, methyl iodide injection time and after-flow time.

Experiments were done under such conditions as shown in Table II.

Table II. Experimental Conditions

| Parameter | Adsorbent | Experimental Range |
|--------------------------------------|--------------------------|--------------------|
| Temperature (°C) | BC-727 | 25 ~ 80 |
| | AgX | 30 ~ 85 |
| | CHC-50 | 30 ~ 80 |
| | SS 208C 5KI ₃ | 20 ~ 65 |
| Relative Humidity (%) | BC-727 | 30 ~ 95 |
| | AgX | 0 ~ 95 |
| | CHC-50 | 30 ~ 85 |
| Face Velocity(cm/sec) | BC-727 | 10 ~ 25 |
| | AgX | 5 ~ 35 |
| Packing Density (g/cm ³) | BC-727 | 0.38 ~ 0.60 |
| | AgX | 1.05 ~ 1.30 |
| Pre-flow (hours) | BC-727 | 0 ~ 22 |
| Injection (hours) | BC-727 | 0.25 ~ 2 |
| After-flow (hours) | BC-727 | 0.1 ~ 10 |

Each experiment was done under the condition that one parameter was varied over the range shown in Table II and the other parameters were fixed. Each value of the fixed parameters is following,

Temperature: 66°C
 Relative Humidity: 70%
 Face Velocity: 20cm/sec
 Packing Density: approximately Apparent Density
 Pre-flow Time: 20 hours
 CH₃I-injection Time: 1 hour
 After-flow Time: 1 hour
 CH₃I-131+CH₃I-127 Concentration: 0.10±0.03mg/m³
 Bed Depth: 1cm x 10

Calculation Method of Removal Efficiency. It is well known that radioactive intensity of the filter elements is to be inversely exponential with bed depth. The typical profile which was shown in Figure 3 was expressed with the following equation,

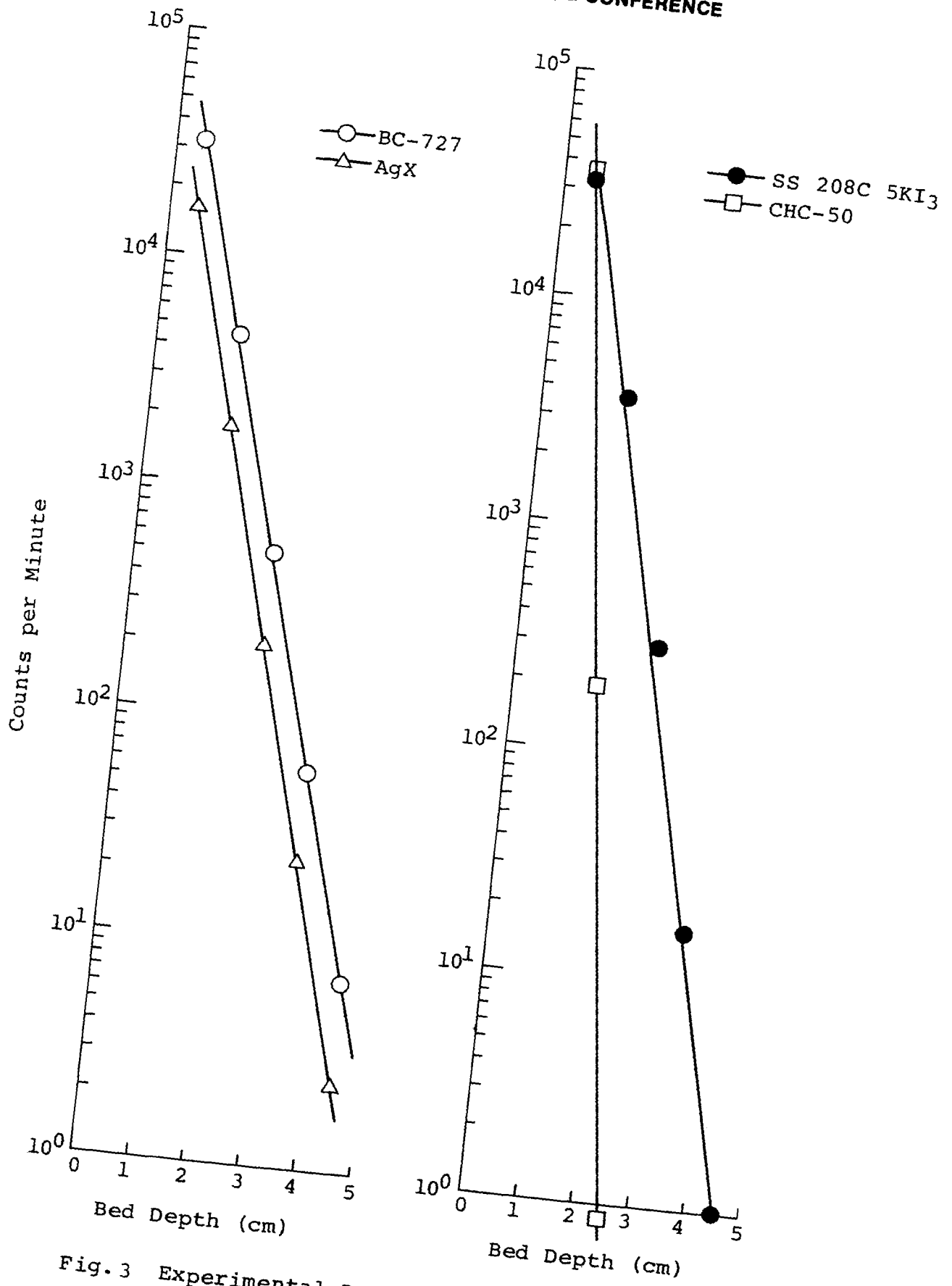

Fig. 3 Experimental Depth Profile of CH₃I-131 with New Adsorbent in Five One-Centimeter Layers

$$Q_i \propto e^{-\mu L_i} \quad (1)$$

where Q_i : radioactive intensity of the i th filter element
 L_i : distance of the i th filter element from inlet of the bed
 i : number of filter element ($i = 1 \sim 10$)
 μ : removal coefficient

The equation (1) is obtained by mass balance in the bed and external fluid phase diffusion model on outer surface of the adsorbent as shown in Appendix, and the removal coefficient μ is presented by the equation,

$$\mu = \frac{k_g a_v}{V_g} \quad (2)$$

Trapping efficiency η is defined with the following equation,

$$\eta = 1 - \frac{C^*}{C_0} \quad (3)$$

where C^* : concentration of CH_3I^* in gaseous phase
 C_0 : inlet concentration of CH_3I^* in gaseous phase

From Appendix, equation (3) is transformed into the equation,

$$\eta = 1 - e^{-\mu L} \quad (4)$$

where L : bed length

Influence of each parameter was evaluated by calculating the removal coefficient from the profile of the radioactive iodine-131 intensity obtained by experiments.

III. Results and Discussion

Effect of Temperature. Figure 4 illustrates results obtained from experiments which were conducted to investigate the effect of temperature on the removal efficiency for such adsorbents as BC-727, AgX, CHC-50 and SS 208C $5KI_3$, and it reflects the well-known effect of increasing removal efficiency with increasing temperature on a new adsorbent (4).

From Figure 4, the removal efficiency was approximated by the following equation,

$$\mu \propto \exp(aT) \quad (5)$$

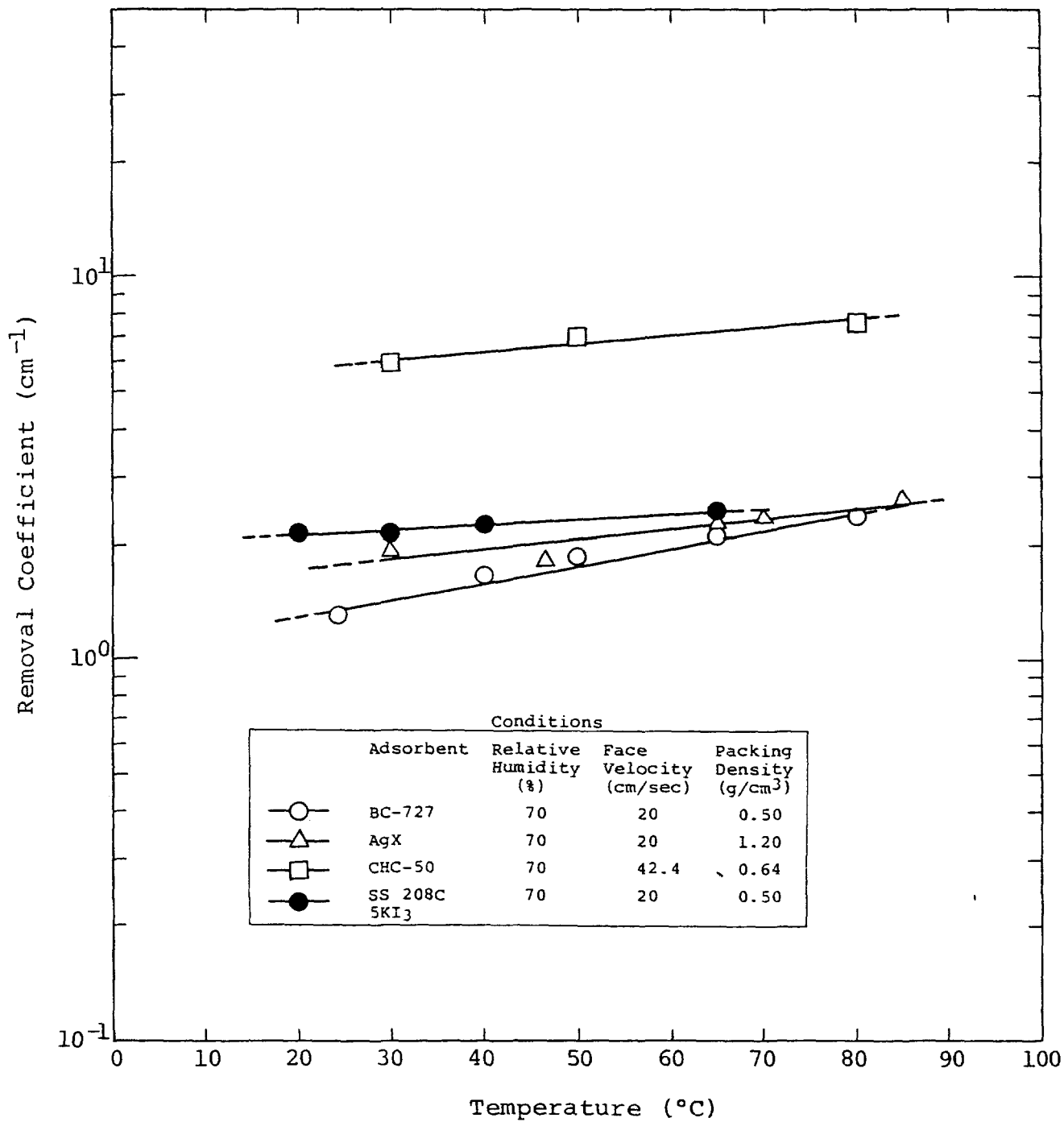

Fig.4 Effect of Temperature

where μ : removal coefficient (cm^{-1})
 T: Temperature ($^{\circ}\text{C}$)
 a: constant (temperature factor)

The constant "a" is shown in Table III, calculated from the equation (5) and the experimental results for each adsorbent.

Values of the constant "a" in Table III appear the following tendency,

- 1) The effect of temperature on BC-727 and SS 208C 5KI₃ is different, in spite of the same removal mechanism, isotopic exchange mechanism, for methyl iodide-131,
- 2) The methyl iodide removal mechanism on AgX and CHC-50 is chemical adsorption, and both adsorbents have the same value of the temperature factor "a".

Effect of Relative Humidity. Figure 5 illustrates results of experiments conducted to investigate the effect of relative humidity on the removal efficiency for such adsorbents as BC-727, AgX and CHC-50. The results appear the well-known tendency of decreasing removal efficiency with increasing relative humidity. This decrease of the removal efficiency is associated with the increase of the amount of water adsorption, because adsorbed water interferes with the interaction of methyl iodide and the adsorbent to an extent depending on the amount of adsorbed water ⁽⁵⁾.

From Figure 5, the effect of relative humidity on the removal efficiency was made an approximation with the equation,

$$\mu \propto \exp (-bH) \quad (6)$$

where μ : removal coefficient (cm^{-1})
 H: relative humidity (%)
 b: constant (relative humidity factor)

The relative humidity factor "b" for each adsorbent was calculated from the equation (6) and the experimental results, and was shown in Table III.

The relative humidity factor "b" of AgX shown in Table III hold to a fairly good approximation in the wide region of dry \sim 95% relative humidity. In case of BC-727, the relative humidity factor "b" in Table III can be applied in the region of 60 \sim 95% relative humidity, that is, the factor "b" for dry \sim 40% relative humidity is different from the above mentioned value, because amount of adsorbed water on the adsorbent decrease suddenly in comparison with amount of adsorbed water in the former region.

From values of the relative humidity factor "b" shown in Table III, the followings were derived,

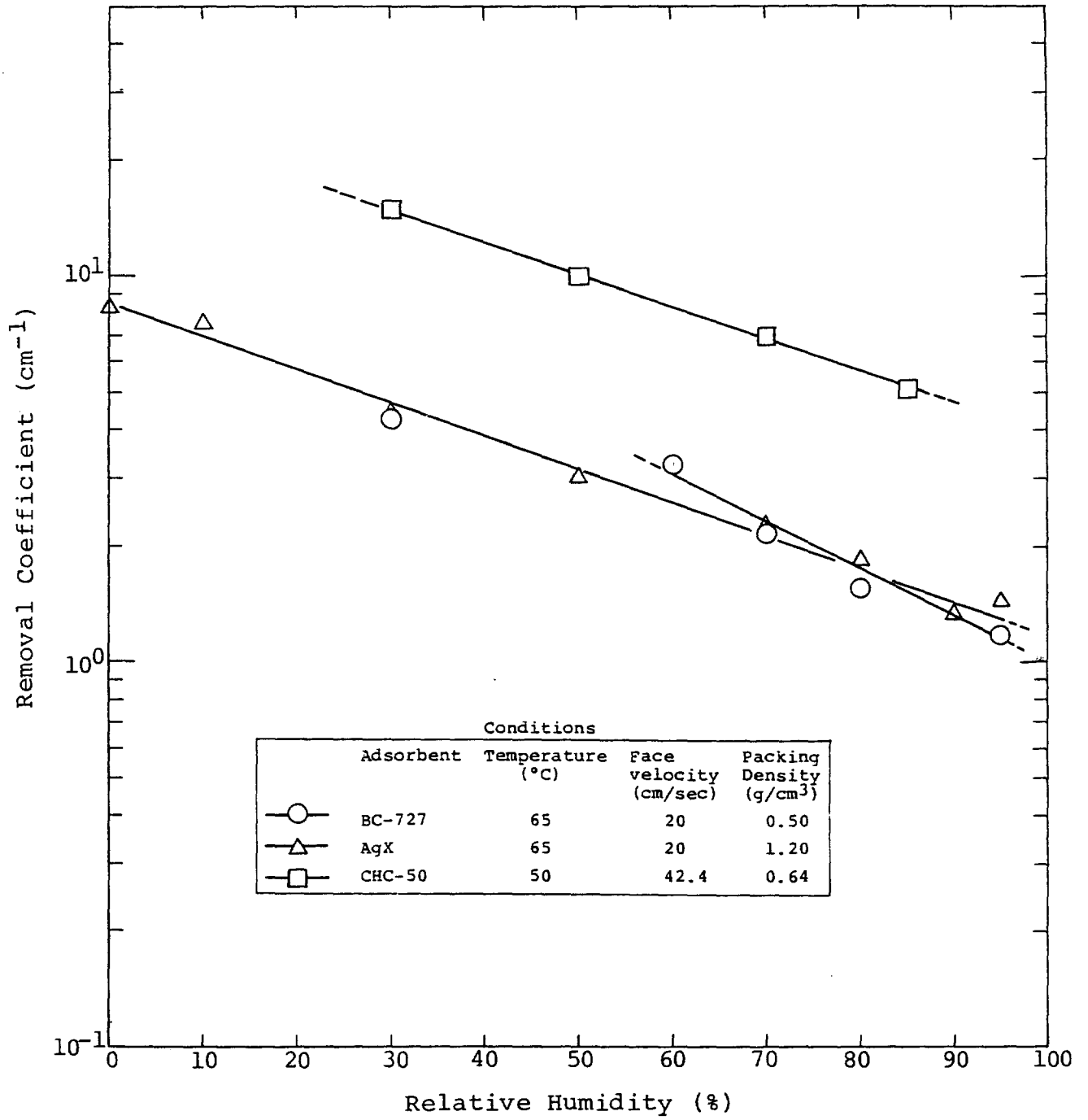

Fig.5 Effect of Relative Humidity

- 1) The effect of relative humidity on AgX is the same as that of CHC-50,
- 2) BC-727 is apt to be influenced by the high relative humidity, compared with other adsorbents.

Effect of Face Velocity. Some papers have been reported on the influence of face velocity on methyl iodide-131 removal with various adsorbents ⁽⁶⁾, ⁽⁷⁾. In most of these reports, however, the influence has been discussed from a combination of the stay time of the feed gas in the bed and the decontamination factor of methyl iodide-131, and has been little discussed from the standpoint of transfer phenomenon of methyl iodide-131 in the bed.

Authors investigated the effect of the face velocity on the methyl iodide-131 removal efficiency from mass transfer theory in order to express the effect by mathematics.

From Appendix, the removal coefficient " μ " of methyl iodide-131 can be expressed by the following equation,

$$\mu = \frac{k_g a_v}{V_g} \quad (2)$$

where

k_g : mass transfer coefficient

a_v : surface area per unit volume of the adsorbent

V_g : face velocity

Mass transfer coefficient " k_g " can be calculated from the experimental equation (Appendix equation) given by Chu et al ⁽⁸⁾. Reynolds Number in the present experiments is from 1 to 30, therefore, the methyl iodide-131 removal coefficient is expressed by following equation,

$$\mu = 34.2(1-\theta) \left\{ \frac{d_p V_g \rho_g}{\eta(1-\theta)} \right\}^{-0.78} \left(\frac{\eta}{\rho_g D_g} \right)^{-2/3} \quad (7)$$

where

μ : removal coefficient

θ : void fraction

d_p : particle diameter

V_g : face velocity

ρ_g : fluid density

η : fluid viscosity

D_g : diffusion constant

From the equation (7), the ratio of the methyl iodide-131 removal coefficient under face velocity V_{g1} to that under face velocity V_{g2} is presented as follows,

$$\frac{\mu_1}{\mu_2} = \left(\frac{V_{g1}}{V_{g2}} \right)^{-0.78} \quad (8)$$

17th DOE NUCLEAR AIR CLEANING CONFERENCE

Figure 6 shows the influence of face velocity on the methyl iodide-131 removal efficiency for BC-727 and AgX. From the equation (8), data points in Figure 6 were fit by the following equation,

$$\mu \propto V_g^{-f} \tag{9}$$

where μ : removal coefficient
 V_g : face velocity
 f : constant (face velocity factor)

The fitting results for the face velocity factor "f" are shown in Table III.

Obtained value of the factor "f" is about 0.8 for both adsorbents, and almost agree with the value in the equation (8). Accordingly, the controlling mechanism of methyl iodide-131 mass transfer in the bed would be external fluid phase diffusion as mentioned in Appendix.

Table III. Summary of Constants of Experimental Equations

| Parameter | Experimental Equation | Adsorbent | Constant |
|------------------------------------|---|--------------------------|-----------------|
| Temperature(T) | Equation (5) $\mu \propto \exp(aT)$ | BC-727 | a = 0.010±0.001 |
| | | AgX | a = 0.006±0.002 |
| | | CHC-50 | a = 0.005±0.001 |
| | | SS 208C 5KI ₃ | a = 0.003±0.001 |
| Relative (H) Humidity | Equation (6) $\mu \propto \exp(-bH)$ | BC-727 | b = 0.028±0.004 |
| | | AgX | b = 0.020±0.001 |
| | | CHC-50 | b = 0.020±0.002 |
| Face (V _g) Velocity | Equation (10) $\mu \propto V_g^{-f}$ | BC-727 | f = 0.822±0.011 |
| | | AgX | f = 0.797±0.020 |

Effect of Packing Density. Figure 7 shows the influence of packing density on the methyl iodide-131 removal efficiency for BC-727 and AgX.

The methyl iodide-131 removal coefficient is expressed by the above mentioned equation (7). Such parameters as d_p , V_g , ρ_g , η and D_g in the equation (7) are independent of void fraction, therefore, the methyl iodide-131 removal coefficient ratio under the different void fraction are appeared as follows,

$$\frac{\mu_1}{\mu_2} = \frac{1 - \theta_1}{1 - \theta_2} = \frac{\gamma_1}{\gamma_2} \tag{10}$$

where μ : removal coefficient

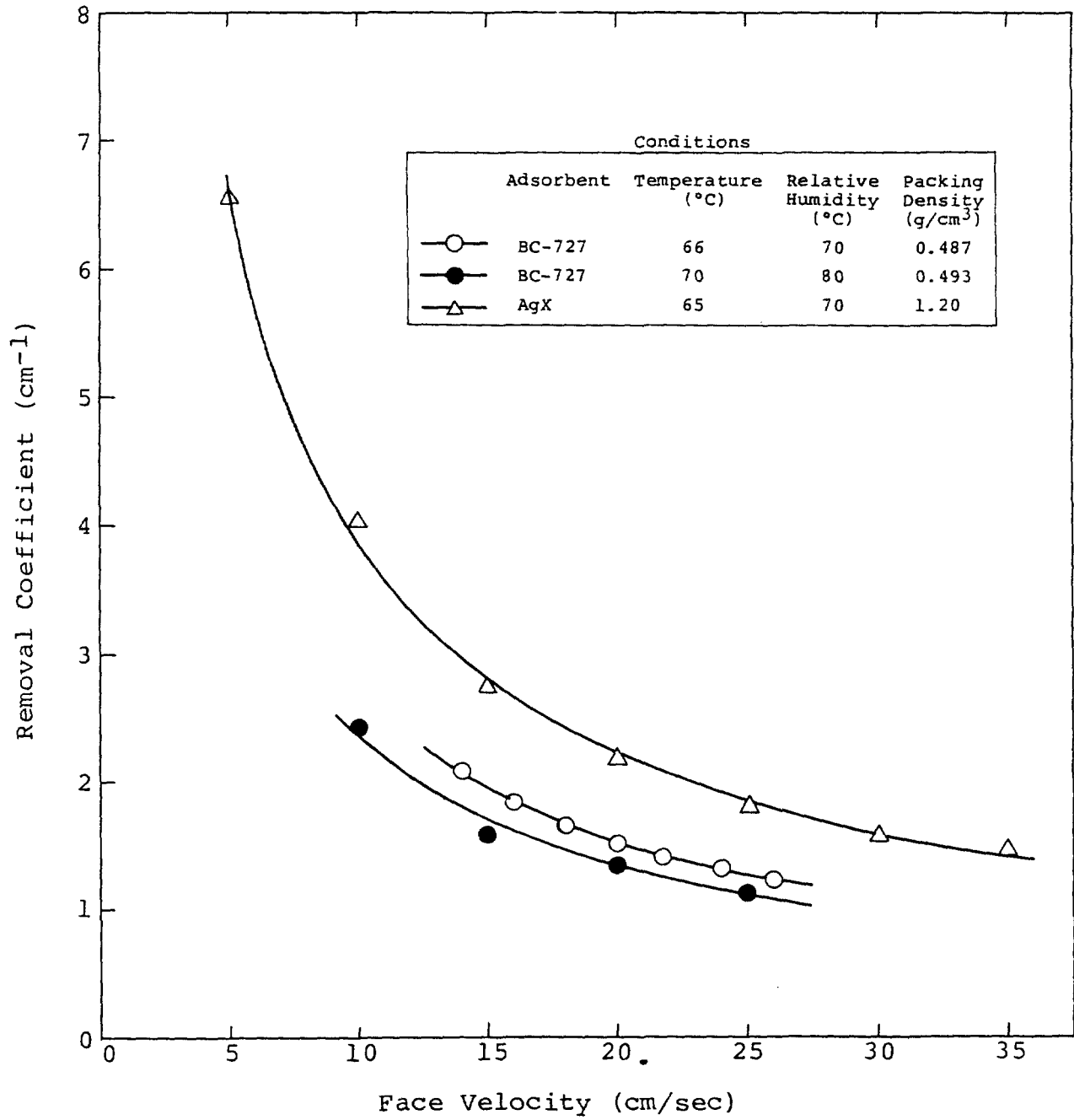

Fig.6 Effect of Face Velocity

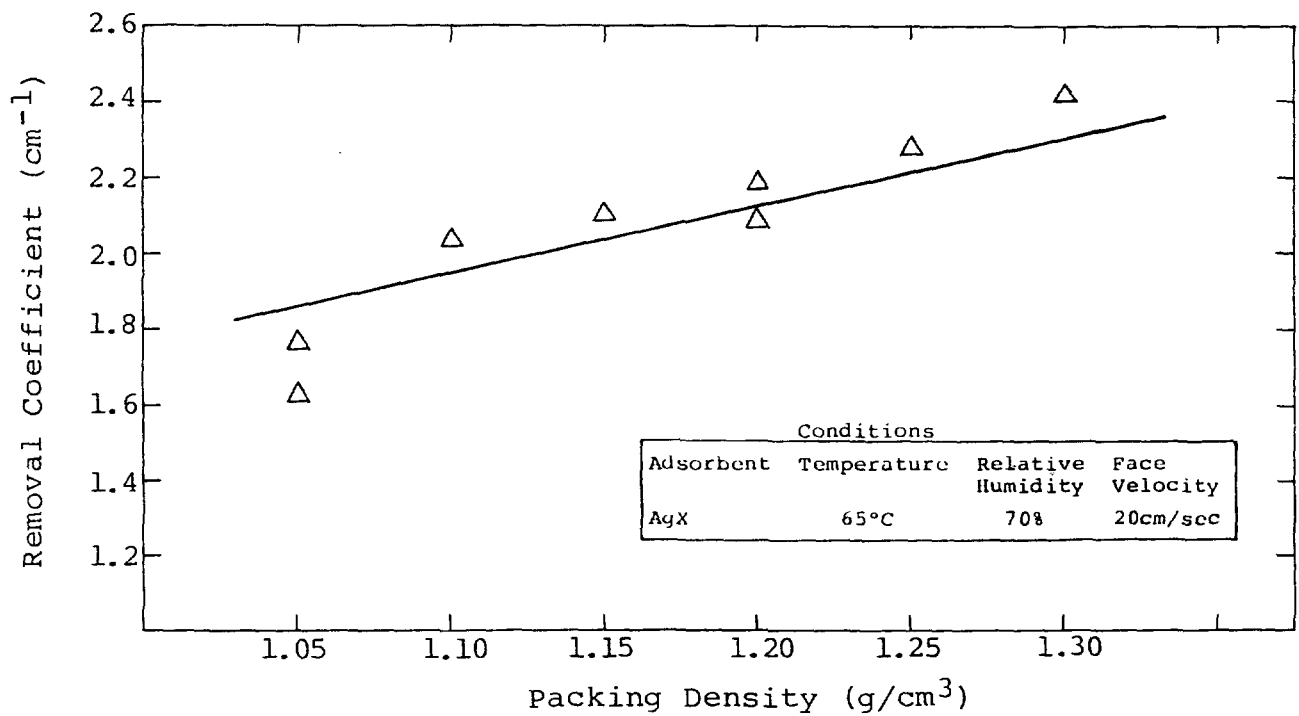
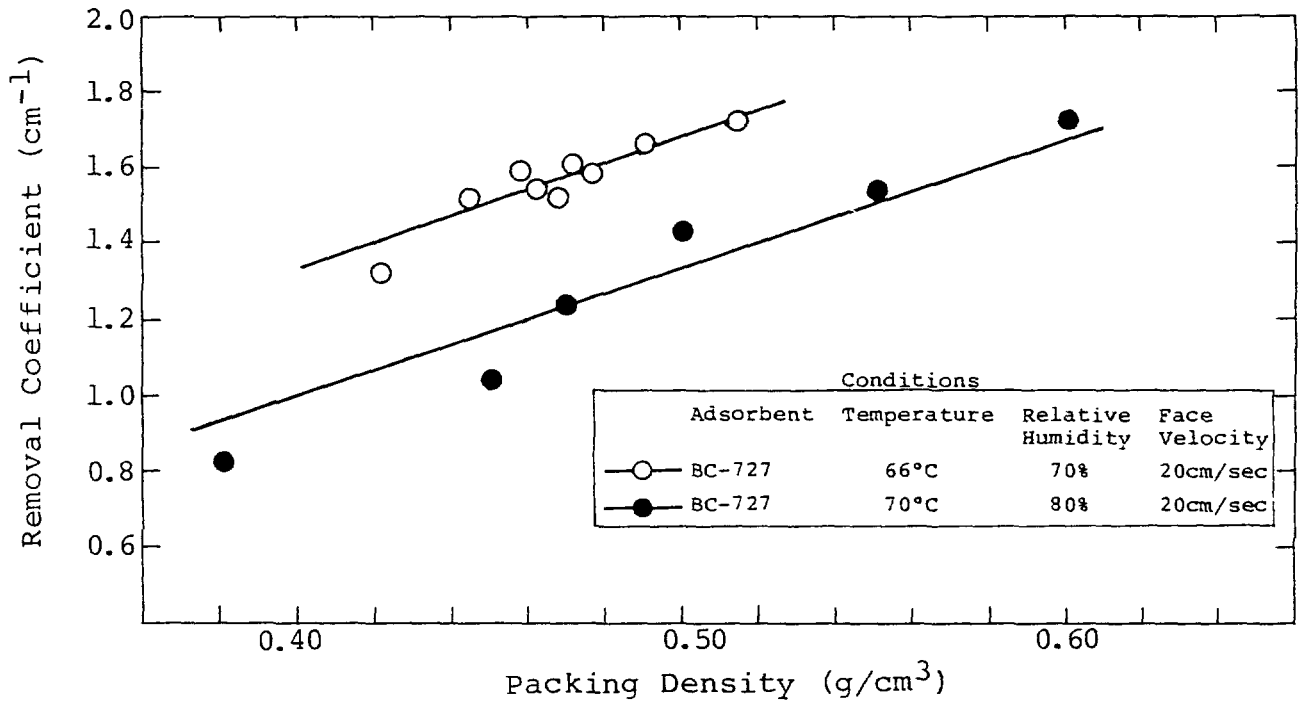

Fig.7 Effect of Packing Density

θ : void fraction

γ : packing density

It is thought that the experimental data in Figure 7 follow the equation (10), and some scatter of the data from the straight line calculated by equation (10) is caused by a variation of adsorbent particle diameter.

Effect of Pre-flow Time. A series of experiments were conducted in order to investigate the effect of the pre-flow time on the methyl iodide removal efficiency.

The results are shown in Figure 8. It is seen that the methyl iodide removal efficiency decreases as the pre-flow time increases in early time, and its efficiency reaches a constant when it reaches a certain value and it will not decrease any more even if the pre-flow time increases.

Figure 9 shows the change of gas temperature at the inlet and the outlet of the bed during the pre-flow time. The inlet and outlet gas has the same temperature before the pre-flow, but outlet gas temperature increases suddenly at the start of the pre-flow and decreases gradually as the pre-flow time increases. The increase of the outlet gas temperature would be caused by heats of water adsorption on adsorbents. In case of the present experimental conditions, water adsorption reaches the equilibrium after the pre-flow time of about 8 hours and temperature of the inlet gas corresponds to that of the outlet gas, as shown in Figure 9.

Changes of the removal efficiency for the methyl iodide seen in Figure 8 would be brought by such distribution of temperature in the bed that was presumed from the change of gas temperature at the outlet shown in Figure 9. Accordingly, the pre-flow time should be taken until the outlet gas temperature became stable.

Effect of Methyl Iodide Injection Time. Figure 10 shows the results of the experiments which were done to investigate the effect of methyl iodide injection time on the methyl iodide removal efficiency. It is seen from Figure 10 that the methyl iodide removal efficiency is not affected by the injection time in the region of 0.25 ~ 2.0 hours.

Effect of After-flow Time. It is well known that the after-flow is performed after methyl iodide injection in order to evaluate the ability of the adsorbent to hold the methyl iodide once it is captured.

It was confirmed that the methyl iodide removal efficiency was not affected by the after-flow time in the region of 0.1 ~ 10 hours as shown in Figure 11.

Evaluation of experimental equation. The methyl iodide trapping efficiency " η " on the adsorbent bed is expressed by the equation (11), as described previously in Calculation Method of Removal Efficiency.

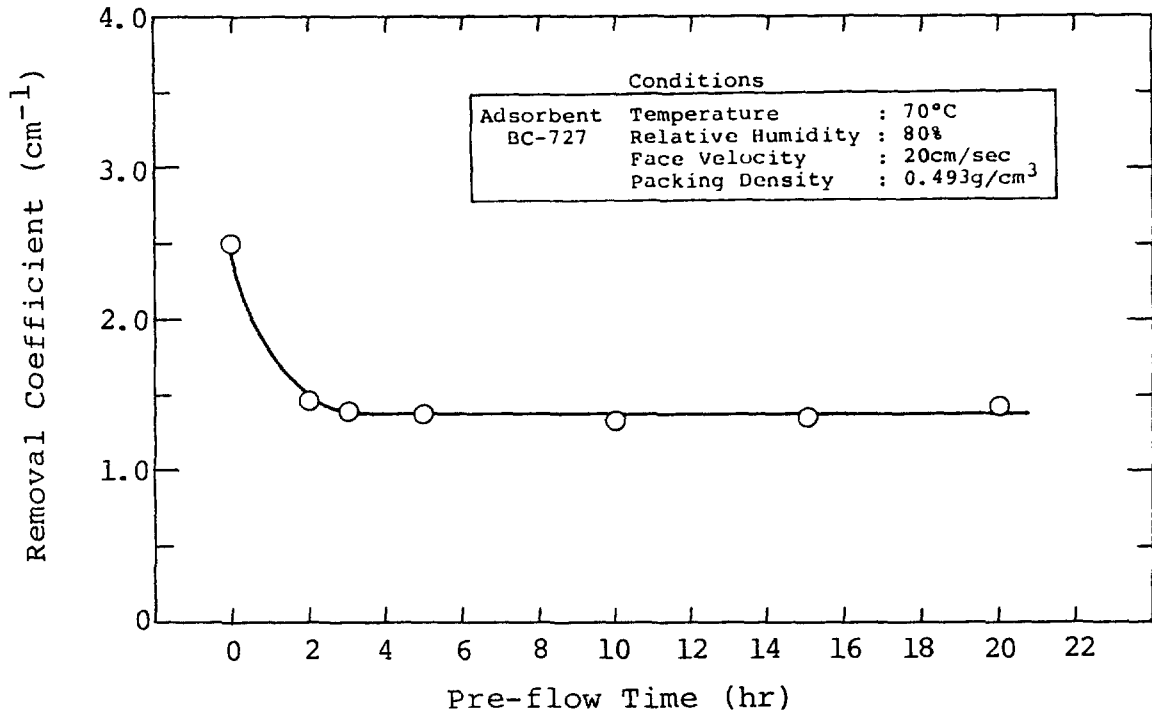

Fig. 8 Effect of Pre-Flow Time

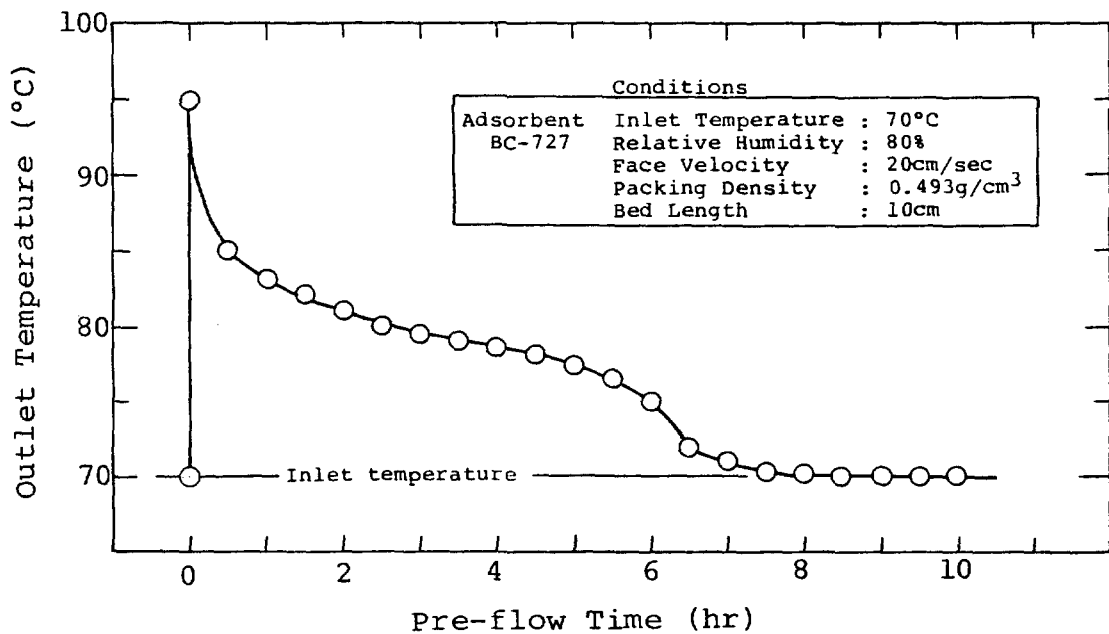

Fig. 9 Change of Outlet Temperature during Pre-flow

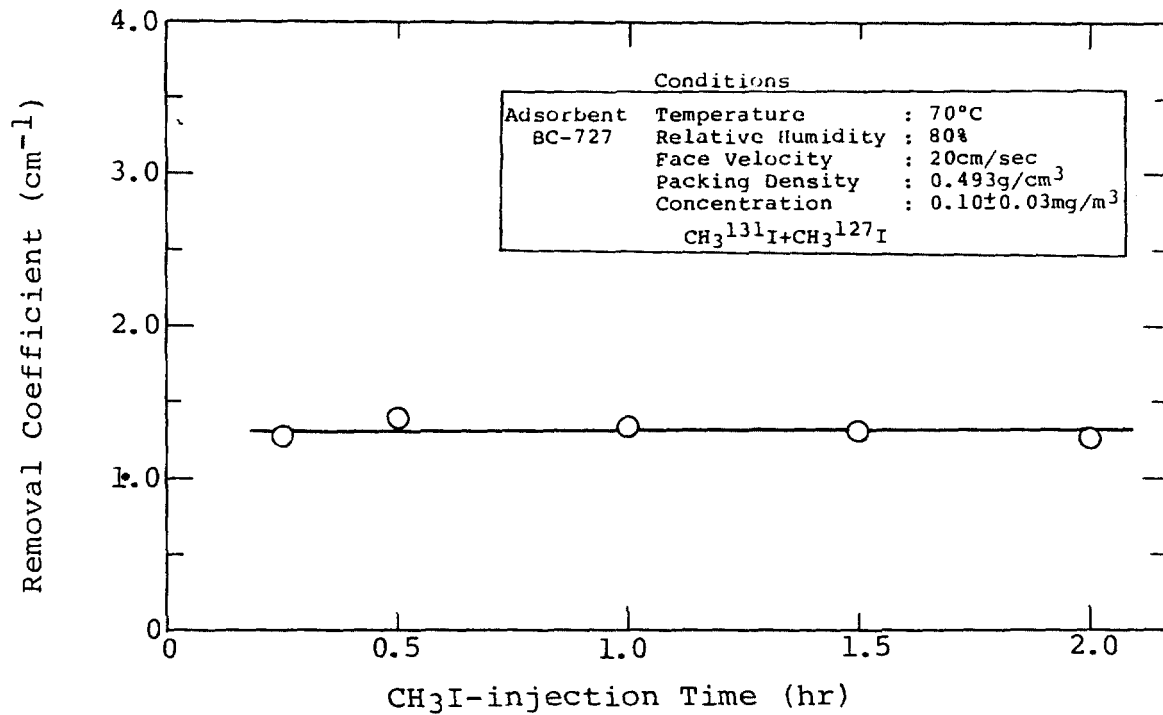

Fig.10 Effect of CH₃I-injection Time

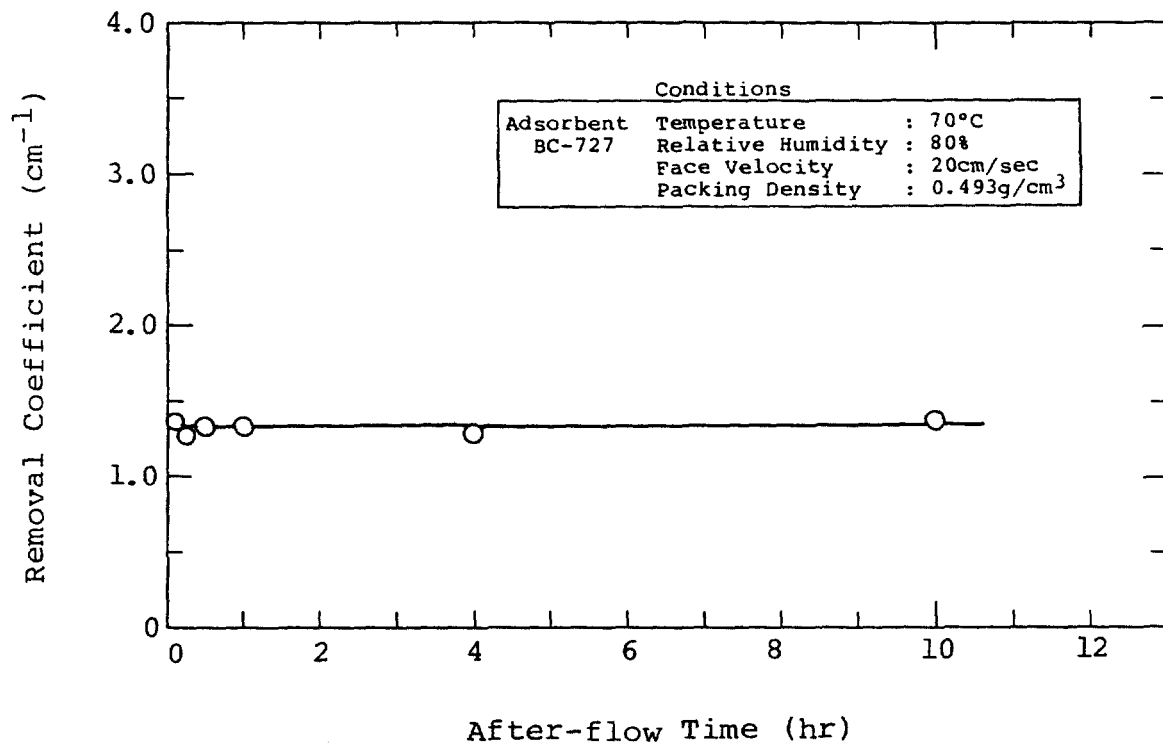

Fig.11 Effect of After-flow Time

$$\eta = 1 - \frac{C^*}{C_0} = F(L, T, H, V_g, \gamma) = 1 - e^{-\mu L} \quad (11)$$

$$\mu = G(T, H, V_g, \gamma) \quad (12)$$

where

- C*: concentration of CH₃I* in gaseous phase
- C₀: inlet concentration of CH₃I* in gaseous phase
- L : bed length (cm)
- T : temperature (°C)
- H : relative humidity(%)
- V_g: face velocity (cm/sec)
- γ : packing density (g/cm³)
- μ : removal coefficient (cm⁻¹)

Authors derived the equation (13) by combining mass transfer model described in Appendix and individual experimental equations (5), (6) and (9) for each parameters.

$$\mu = A \cdot \gamma \cdot V_g^{-f} \cdot \exp(aT - bH) \quad (13)$$

where

- μ : removal coefficient (cm⁻¹)
- γ : packing density (g/cm³)
- V_g: face velocity (cm/sec)
- T : temperature (°C)
- H : relative humidity (%)
- A : constant
- a : constant (temperature factor)
- b : constant (relative humidity factor)
- f : constant (face velocity factor)

In order to check applicability of the above equation, a series of experiments were conducted. Table IV shows the experimental conditions. Standard conditions in Table IV were used to obtain the constant "A" in the equation (13).

17th DOE NUCLEAR AIR CLEANING CONFERENCE

Table IV. Experimental Conditions for Checking The Experimental Equation

| Parameter | Standard Condition | Experimental Range |
|--------------------------------------|--------------------|--------------------|
| Temperature (°C) | 66 | 63 ~ 69 |
| Relative Humidity (%) | 70 | 55 ~ 85 |
| Face Velocity (cm/sec) | 20 | 14 ~ 26 |
| Packing Density (g/cm ³) | 0.468 * | 0.421 ~ 0.515 |
| | 0.487 ** | 0.438 ~ 0.536 |

* Adsorbent: BC-727, Lot No. M-2767

** Adsorbent: BC-727, Lot No. M-3000

The experimental results are shown in Figure 12. The calculated value of the methyl iodide removal efficiency agreed with the experimental results within ±20%, as shown in Figure 12.

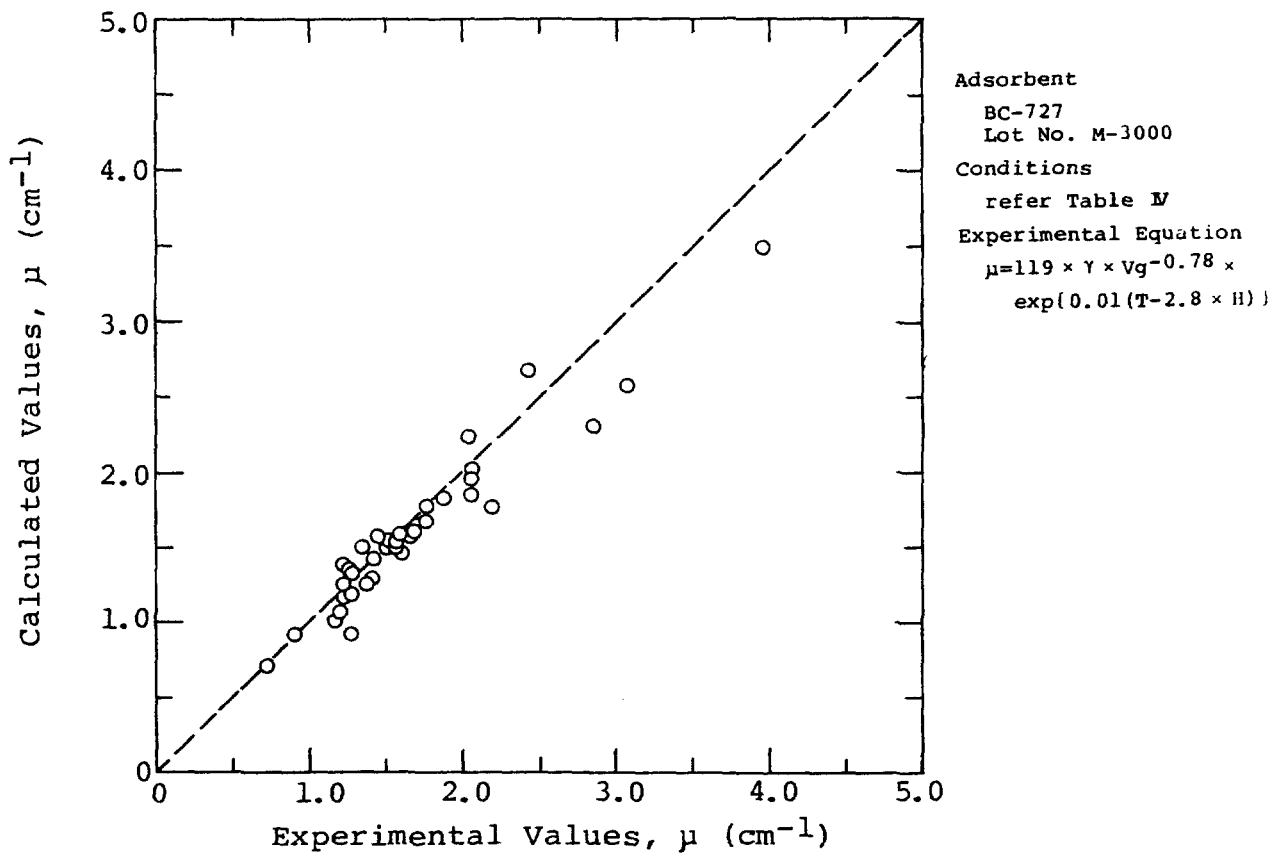
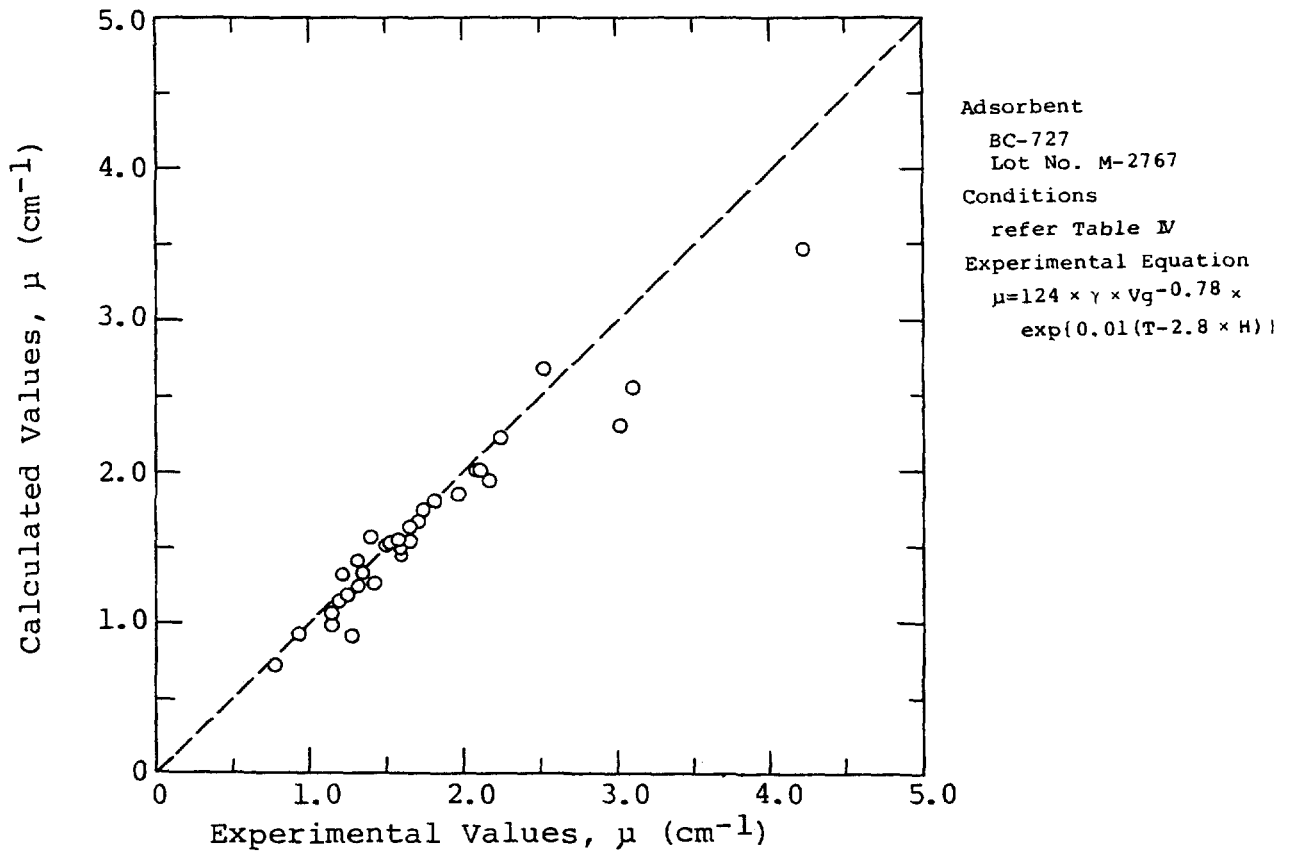

Fig.12 Comparison of The Experimental Results with Calculated Results

IV. Conclusion

The experimental equation for evaluating the methyl iodide removal efficiency of adsorbents was derived from a series of experiments. It was concluded that the removal efficiency calculated from the present equation agreed well with the experimental value.

References

1. D. A. Collings, L. R. Taylor, and R. Taylor, "Development of Impregnated Charcoals for Trapping Methyl Iodide at High Humidity", AEC Report CONF-660904, (1966)
2. G. W. Parker, G. E. Cheek, and A. Ferreli, "Retention of Methyl Iodide by Impregnated Carbons Under Ambient Conditions", AEC Report CONF-660904, (1966)
3. D. T. Pence, F. A. Duce, and W. J. Maeck, "Developments in the Removal of Airborne Iodine Species with Metal-Substituted Zeolites", AEC Report CONF-740807, (1974)
4. J. R. Hunt, L. Rankovic, R. Lubbers, and J. L. Kovach, "Iodine Removal Adsorbent Histories, Aging and Regeneration", ERDA Report CONF-760822, (1976)
5. R. D. Ackley, R. E. Adams, and W. E. Browning, Jr., "Removal of Radioactive Methyl Iodide from Steam Air Systems", USAEC Report ORNL-4040, (1967)
6. V. R. Dietz, C. H. Blachly, and L. A. Jones, "Dependence of Gas Penetration of Charcoal Beds on Residence Time and Linear Velocity", ERDA Report CONF-760822, (1976)
7. D. A. Collins, L. R. Taylor, and R. Taylor, "The Development of Impregnated Charcoals for Trapping Methyl Iodide at High Humidity", British TRC Report 1300(W), (1967)
8. Ju Chin Chu, James Kalil, and William A. Wetteroth, "Mass Transfer in a Fluidized Bed", Chemical Engineering Progress, Vol. 49, No.3, p. 141 ~ 149, (1953)

Appendix

Mass Transfer Model of Methyl Iodide

The following model for mass transfer model of methyl iodide was presumed.

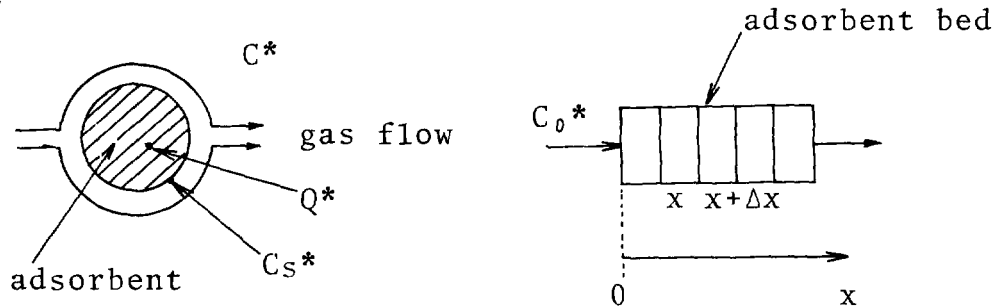

*: radioactive

- C^* : concentration of CH_3I^* in gaseous phase (mol/cm^3)
- C_S^* : concentration of CH_3I^* on adsorbent external phase (mol/cm^3)
- C_0^* : inlet concentration of CH_3I^* in gaseous phase (mol/cm^3)
- Q^* : concentration of I^* on the adsorbent (mol/g)
- V_g : face velocity (cm/sec)
- γ : packing density (g/cm^3)
- t : time (sec)
- x : axial distance (cm)

Mass Balance

$$-V_g \frac{\partial C^*}{\partial x} + \frac{\partial Q^*}{\partial t} = 0 \quad (14)$$

(Gas diffusion was neglected.)

External Fluid Phase Diffusion

$$\gamma \frac{\partial C^*}{\partial x} = k_g a_v (C^* - C_S^*) \cong k_g a_v C^* \quad (15)$$

- where
- k_g : mass transfer coefficient
 - a_v : surface area per unit volume of the bed (cm^2/cm^3)

From the equations (14) and (15), the next equations can be obtained.

$$C^*(x) = C_0 * \exp \left(- \frac{k_g a_v}{V_g} x \right) \quad (16)$$

$$Q^*(x,t) = \frac{k_g a_v}{\gamma} C_0 * t \exp \left(- \frac{k_g a_v}{V_g} x \right) \quad (17)$$

Consequently, the methyl iodide removal coefficient " μ " which was defined by the equation (1) described in Calculation Method of Removal Efficiency is expressed by the equation (2),

$$\mu = \frac{k_g a_v}{V_g} \quad (2)$$

Mass transfer coefficient " k_g " can be calculated the following equations (18), (19), (20) and (21) given by Chu et al⁽⁸⁾.

$$10000 > Re' > 30, \quad J = 1.77 (Re')^{-0.44} \quad (18)$$

$$30 > Re' > 1, \quad J = 5.7 (Re')^{-0.78} \quad (19)$$

$$Re' = \frac{d_p V_g \rho_g}{\eta (1-\theta)} = (N_{Re'}) \quad (20)$$

$$J = \frac{k_g}{V_g} \left(\frac{\eta}{\rho_g D_g} \right)^{2/3} = \frac{k_g}{V_g} (NSc)^{2/3} \quad (21)$$

where

- $N_{Re'}$: modifide reynolds number
- NSc : schmidt number
- d_p : particle diameter
- ρ_g : fluid density
- η : fluid viscosity
- θ : void fraction
- D_g : diffusion constant

Surface area per unit volume of the bed " a_v " can be calculated by the equation (22), assuming the adsorbent to be a sphere.

$$a_v = \frac{6 (1-\theta)}{d_p} \quad (22)$$

DISCUSSION

CSILLAG: I would like to know if the equation holds for 100% relative humidity?

SHIOMI: No, because we can not obtain reliable experimental data under 100% relative humidity conditions.

BELLAMY: Is it true that the only carbons tested were new virgin carbons?

SHIOMI: Yes.

BELLAMY: Was your equation checked against data from another laboratory?

SHIOMI: No, but this would be a good idea. We want to evaluate our equation for used adsorbents.

DEUBER: I would like to draw attention to the fact that retention increases with increasing residence time. To investigate the effect of face velocity, one should compare it at the same residence time?

SHIOMI: Thank you. I think so.

DEUBER: Did you do some tests on the influence of concentration? I ask this because in the past some have found an increase and some a decrease with changing concentration.

SHIOMI: We have not tested that relationship so far.

17th DOE NUCLEAR AIR CLEANING CONFERENCE

DATA ANALYSIS OF IN PLACE TESTS OF IODINE FILTERS IN THE FRENCH NUCLEAR FACILITIES

P. Mulcey, L. Trehen and J.L. Rouyer
Institut de Protection et de Sûreté Nucléaire
Commissariat à l'Energie Atomique - France

Abstract

The first part of the paper is devoted to the characteristics of the iodine adsorbers which equip French air cleaning systems and to their operating conditions.

The analysis of the data obtained with in place testing of iodine filters is developed further on. Data already available and new complementary data to be obtained are examined.

An analysis of the results of in place tests will give an idea of the rejection level observed for acceptance tests and will show the possible influence of several parameters (air velocity, relative humidity, ageing) upon the measured decontamination factors.

Finally, an assessment is made of the evolution of French cleaning systems during the last few years and of the complementary measurements to be carried out in the frame of the standardized test method.

I. Introduction

French legislation on the inspection of ventilation systems in nuclear facilities⁽¹⁾⁽²⁾ states that the efficiency of their gaseous effluent cleaning systems must be measured at least once a year.

Moreover because of the TMI₂ accident the Permanent Group in charge of Nuclear Reactors⁽³⁾ has decided to bring the inspection frequency to three months in the case of ventilation systems where the iodine adsorbers are in service permanently.

The method adopted in France for many years is now covered by and AFNOR Experimental Standard⁽⁴⁾.

The technique, consisting of an in placetest on the air cleaning system as a whole by the use of a radioactive tracer (iodine 131 - labelled I₂ or ICH₃), is the only method used so far on all iodine filters fitted.

17th DOE NUCLEAR AIR CLEANING CONFERENCE

It gives the overall efficiency of the air cleaning unit at the moment of testing, for working conditions as close as possible to those for which the trap was designed.

The results obtained in this way on certain air cleaning systems have been analysed with a dual purpose :

- to examine the data available now and the new data required to improve the analysis and management of the filters to maximum advantage ;
- to show up any correlations between the decontamination factor and certain parameters affecting its measurement (air velocity, relative humidity, weathering).

In our opinion the method used in France, and more generally in Europe, to measure the decontamination factor of iodine traps must on no account be questioned or fundamentally changed, since no other available method can evaluate the efficiency of the system as a whole for working conditions close to those found in normal operation or in the event of accident.

However from the results obtained by this method it is often difficult to estimate the relative contributions of the leakage rate and the intrinsic efficiency of the active charcoal in the overall decontamination factor, especially when this is small.

For other technical reasons examined below, other measurements, besides the present one, are needed to enrich the data used for calculating the efficiency at the time of inspection and estimating its variation in the time interval between two decontamination factor measurements.

The test method has already been published(5), (6) and will therefore not be described again here.

General remarks

1. Characteristics of iodine adsorber units

All power reactor systems and most laboratory and experimental reactor air cleaning units are equipped with standard 610 x 610 x 292 mm cells, installed either in bag-in bag-out housings or on honeycombed metal frames (filtering walls).

These cells contain about 35 kg of active charcoal impregnated to 1 % with potassium iodide. Coal base charcoal 8-16 mesh ASTM, has usually been used in preference to coconut base charcoal because of its better efficiency at high relative humidity but the fitting of preheaters on new facilities could eventually lead to a review of this choice.

17th DOE NUCLEAR AIR CLEANING CONFERENCE

The charcoal bed is 5 cm deep ; at the nominal flow rate of 1200 m³/h for 25 cm/s the residence time averages 0.2 s.

A sample of this active charcoal is checked in the laboratory beforehand (2-ton batches). To be accepted the sample must have a K factor(8) greater than 8 for a 25 cm/s air velocity and a 90 % relative humidity.

It is practically impossible to correlate the efficiency of the samples with that of the adsorbers these generally being equipped with cells from different active charcoal batches.

2. Working conditions

a) Air velocity

The gas velocity through the active charcoal, too fast on the earliest ventilation systems, has gradually been brought to a value of around 25 cm/s and even less in certain cases.

b) Active charcoal bed depth

For new reactors, especially the 1300 MW(electric) type the bed depth has been increased to 10 cm.

c) Relative humidity

To improve the efficiency of the adsorbers the systems are being equipped more and more with preheaters, which guarantee a relative air humidity below 40 %.

d) Degree of use

A few circuits are ventilated permanently and the efficiency of the adsorbers deteriorates fairly quickly as a result. In all other cases the adsorber is by-passed in normal operation. The insulating dampers must be particularly well made to avoid by-pass leaks. On new ventilation systems the increasing tendency is to use double dampers with the inner part under pressure.

e) Charcoal conditioning

Pneumatically rechargeable carbon adsorbers have been developed over the last few years and are being fitted on certain circuits.

The use of these devices is likely to modify the test procedures.

This point will be examined below.

II. Analysis of data concerning iodine adsorbers

1. Available data

These data are obtained either at the time of testing or during the working period between tests.

a) Data supplied by the test

The first information is obtained by visual inspection of the trap when faults can be detected on the cells themselves (active charcoal leaks; poor air-tightness assembly). During this inspection the ventilation flow sheet is also checked for testing purposes.

The measurements carried out next concern :

- the flow rate through the iodine adsorbers. Whenever possible the pressure drop of the adsorber is measured and checked for consistency with the flow rate determined in the duct ;

- the relative humidity at which the test is performed, to check that the preheaters are working properly ;

- the overall efficiency of the system, obtained from estimates of the iodine 131 activity fixed on the charcoal samples taken.

b) Operational data

In most cases the only working data available are those obtained from periodic flow rate measurements and pressure drop readings for traps on continuously operating circuits.

2. Supplementary data

Certain additional information is necessary to improve the evaluation of iodine traps.

a) Acceptance tests

These should be supplemented by a sampling qualification measurement applicable to each new kind of circuit or facility . This would be especially useful for older types of circuit where requirements for sampling points have not always been foreseen at the design stage.

b) Periodic tests

It is becoming more and more necessary to have a fast and accurate means of estimating leakage of the facility (assembly, by-pass dampers,...) so that in certain cases, when the measured overall efficiency falls below the required level, repairs can be made without changing the cells.

17th DOE NUCLEAR AIR CLEANING CONFERENCE

c) Operation

- For circuits which in normal operation are normally by passed and brought into play only on special occasions (refuelling operations, gaseous effluent handling line...) it would be possible, knowing the number of hours in service, to estimate the probable ageing of the traps and to inform the operator of the risks involved in working with an air cleaning system of efficiency below safety standards.

- It would also be advisable to generalise the periodicity of flow rate measurements on circuits in permanent use, since any operational or configurational anomalies would then be detected.

III. Analysis of results

The results were analysed from two viewpoints : 1 - the rejection level observed at reception of air cleaning units before start up of the facility ; 2 - possible correlations between the measured efficiencies and the different parameters involved (air velocity, relative humidity and weathering of the charcoal).

1. Rejection levels observed on reception

The analysis was carried out on twelve 900 PWR type reactors distributed over 3 different sites.

The results are given in the table below :

Table. Rejection ratio
Expressed in percentage of the total number of tests performed

| Site | Number of absorbers per site | Rejection ratio | | |
|-------|------------------------------|-----------------|--------------------|---------------------|
| | | Acceptance test | First routine test | Second routine test |
| A | 34 | 0 | 30 | 0 |
| B | 35 | 2.9 | 38.5 | 33.3 |
| C | 37 | 8.1 | 50 | 44.4 |
| TOTAL | 106 | 3.8 | 39.5 | 25.9 |

17th DOE NUCLEAR AIR CLEANING CONFERENCE

In most cases of below standard efficiency the causes are not known exactly. For one circuit the poor measured value was due to a fault in the filter housing design which was remedied on the spot. In the other cases failure can be attributed to defective assembly of the elements or to paintwork carried out after the adsorbers were fitted. Once the filter elements had been changed the values were up to standard.

2. Influence of the air velocity and relative humidity

Attempts were made to correlate the efficiencies measured on reception with the air velocity and relative humidity.

The analysis was performed on all the air cleaning systems of the containment buildings for the 12 reactors mentioned above.

The nominal flow rate of these systems, which work in close circuit, corresponds to an air velocity of 26.1 cm/s and a 0.19 s. apparent residence time in the charcoal.

For this series of tests the relative humidity of the air passing through the adsorbers ranged from 15 to 40 %.

a) Influence of the air velocity

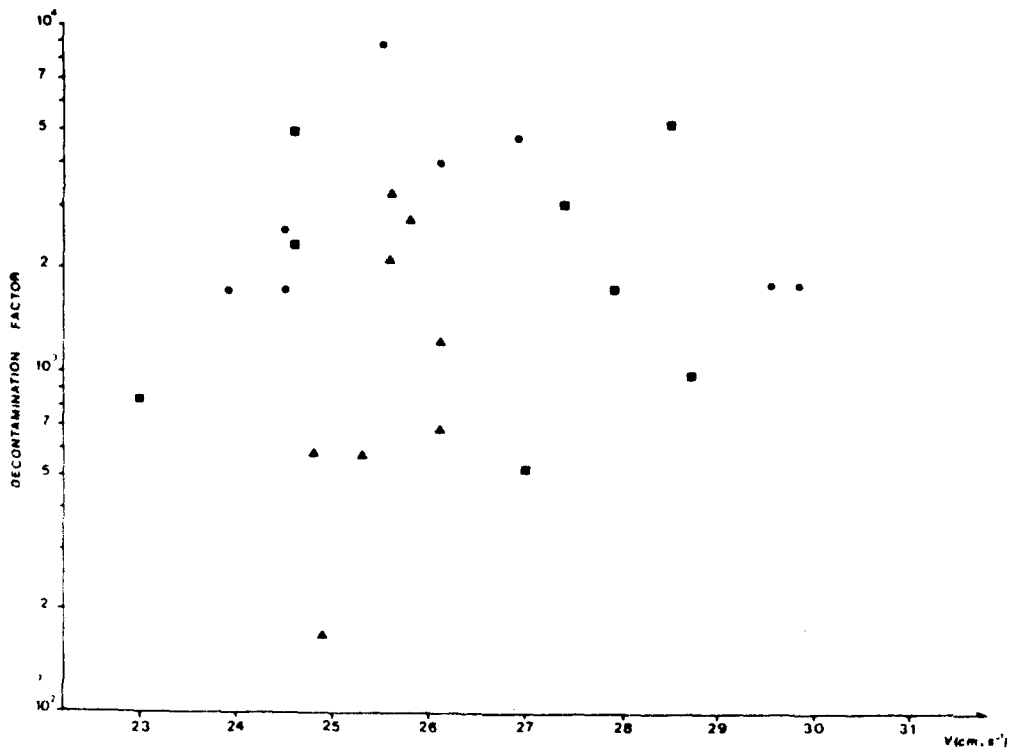
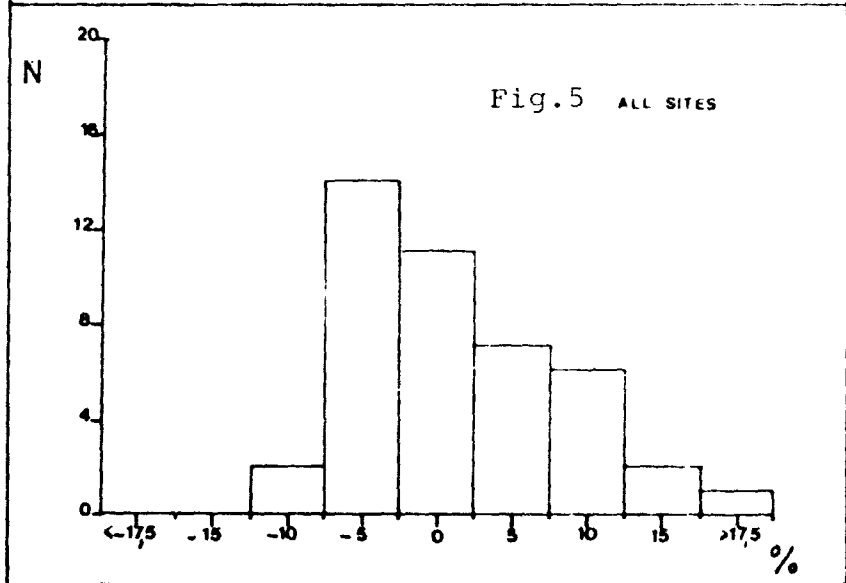
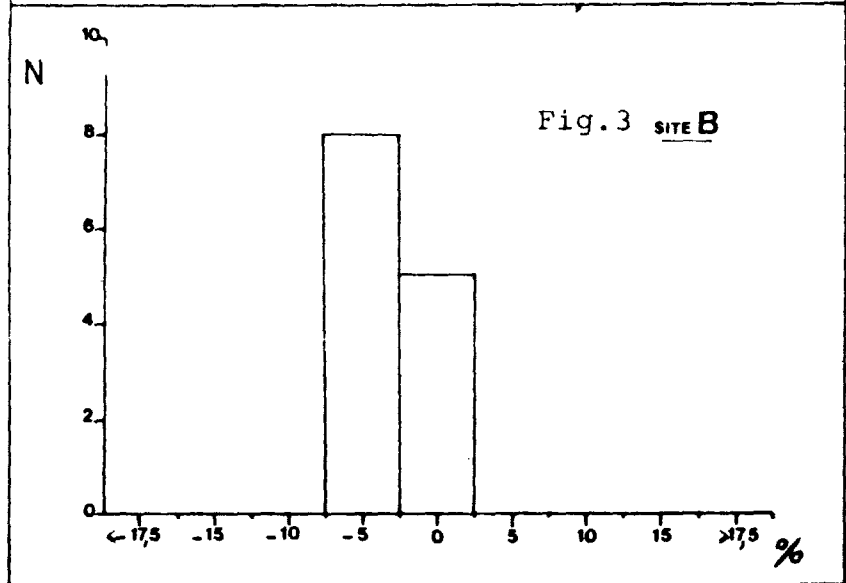
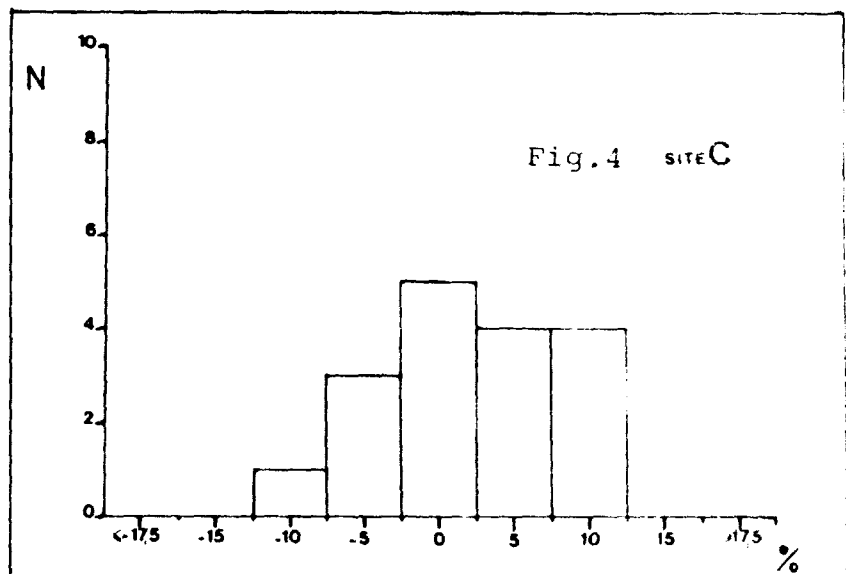
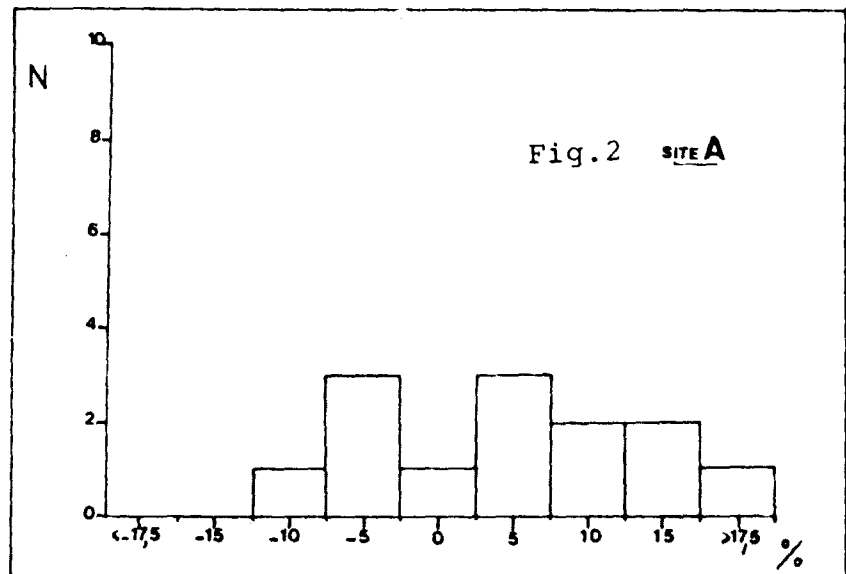

Fig.1



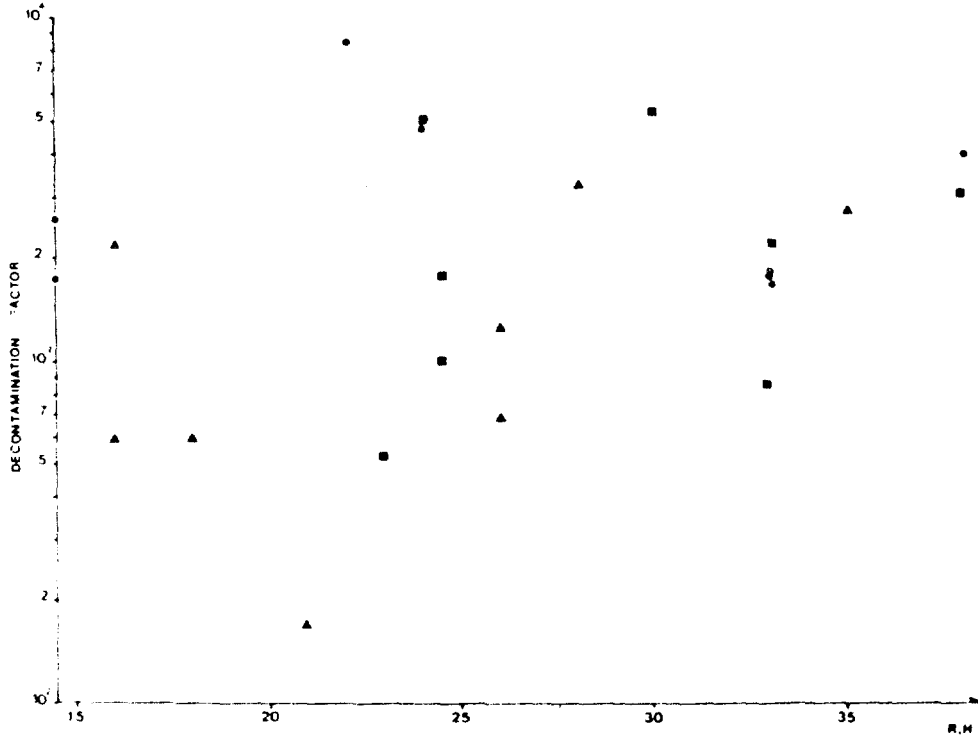

Fig.6

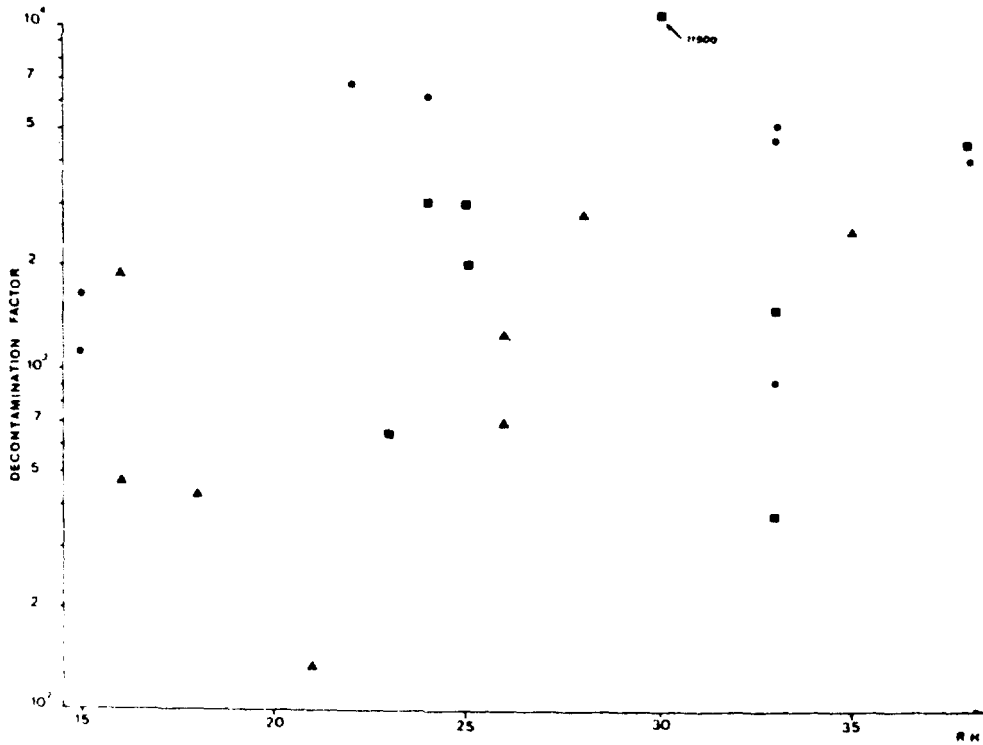

Fig.7

17th DOE NUCLEAR AIR CLEANING CONFERENCE

The results, given on figure 1, show no correlation between the measured efficiency and the air velocity in the range 23 to 30 cm/s.

Figures 2 to 5 show the air velocity distribution expressed in percentage deviation from the design flow rate for the systems at the 3 sites taken separately and together.

b) Influence of relative humidity

The results are shown on figures 6 and 7.

Figure 6 corresponds to the measured efficiency and figure 7 to the efficiency reduced to the design flow rate by a logarithmic correction. Again no correlation can be established.

This analysis of results, which should be extended to all air cleaning units, suggests that the efficiency of the air cleaning system is limited by the quality of the system, the assembly tightness and the leak rate of the units installed (usually around 1 to 2 x 10⁻⁴) and is independent of air velocity and relative humidity (below 40 %) for a rather large range about the nominal operating conditions.

3. Influence of weathering

The weathering effect on iodine adsorbers in permanent operation has been studied on a system fitted with 4 charcoal filter trains working in parallel at an air flow rate of about 40.000 m³/h each.

The efficiency of each train was tested at 3 monthly intervals, the lifetime of the traps being about 6 months.

The results, given on figures 8 and 9, correspond to tests carried out on the same system at different times and are expressed by the apparent K factor of the adsorber ($K = \frac{\log E}{\tau}$, with E the measured efficiency and τ the average air residence time in the charcoal,

It is observed that :

- the initial efficiency of train D is systematically below average, showing a fault in the ventilation design ;

- since weathering is more pronounced during the second six month period the initial efficiency is limited by design and assembly defects ;

- weathering varies from one train to another, showing that their flow rates must be more carefully balanced after the test.

17th DOE NUCLEAR AIR CLEANING CONFERENCE

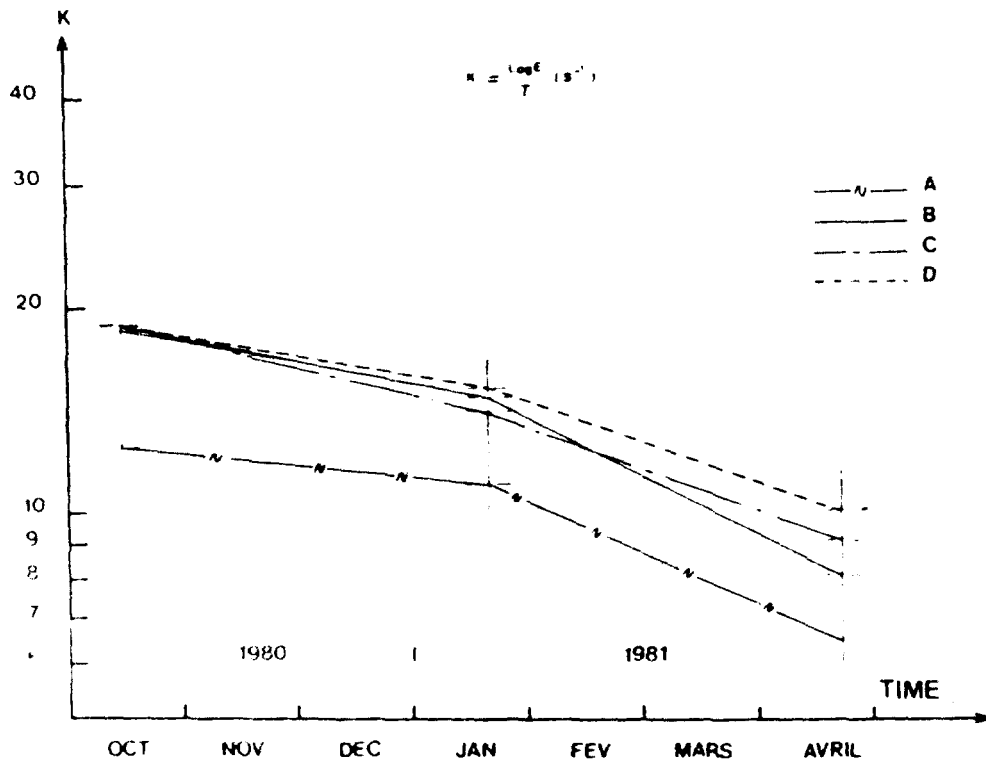

Fig. 8

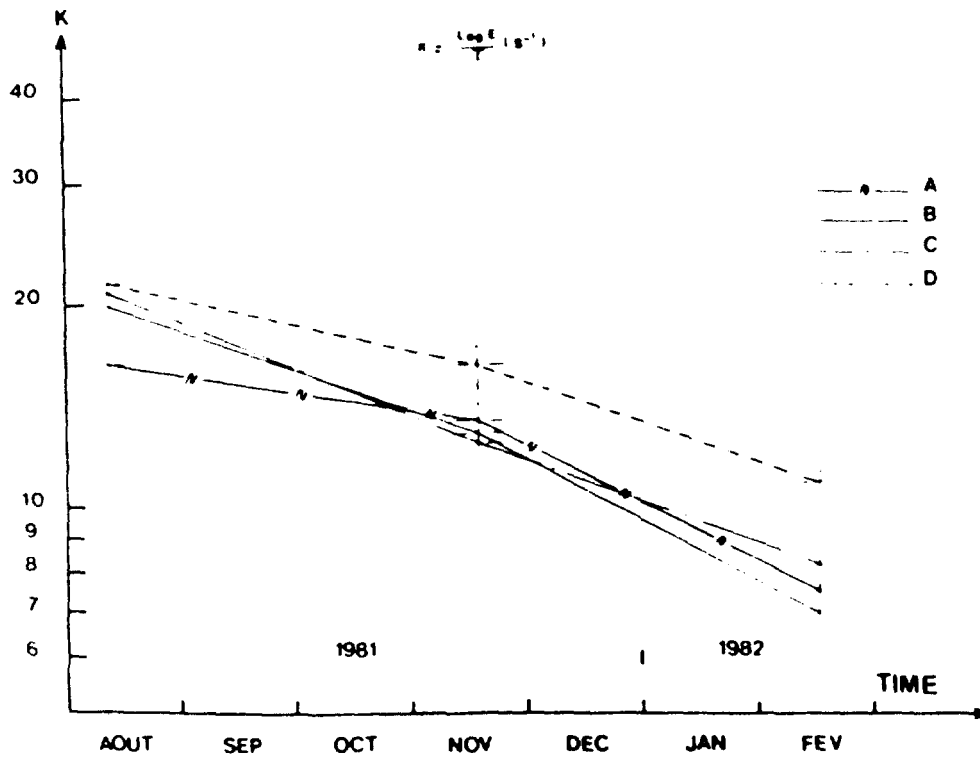

Fig. 9

17th DOE NUCLEAR AIR CLEANING CONFERENCE

Lack of attention to this flow rate equilibrium factor is troublesome for two reasons :

- the train taking the greatest flow rate ages more quickly (proportionately, in a first approximation, to the volume of air passing through) ;

- its efficiency is lowered, all other things being equal, by the higher air velocity.

In the event of an accident the efficiency of the set-up may in fact be unnecessarily reduced.

IV. Development of equipment and means of inspection

1. Development of equipment

The main improvements made to iodine adsorbers over the last few years (9) (10) concern :

- systematic by passing of iodine filters wherever possible ;
- fitting of new facilities with preheaters to lower the relative humidity and improve efficiency, especially for methyl iodine trapping ;
- use of rechargeable carbon adsorbers, accompanied by a systematic increase to 10 cm in the bed depth.

2. Development of inspection methods

a) Needs

An inactive testing method to supplement the normalised inspection should be developed for the following reasons ;

- Qualification of sampling points

A conventional tracer method must be used here so that the representativity of sampling points specific to iodine tests may be determined and if necessary their position changed, or if this is impossible a correction factor applied to the measured activity. This application is intended above all for circuits of an older design where the configuration cannot always guarantee the homogeneity of the tracer at the sampling points or at the trap itself. This application refers to a standard tracer method.

- Leak measurements on ventilation systems under pressure

On a few circuits the air cleaning units are placed downstream from the blower and are hence under higher pressure than the surrounding premises.

17th DOE NUCLEAR AIR CLEANING CONFERENCE

In such cases a leak measurement is necessary in order to detect any anomaly liable to cause radioactive contamination of personnel or premises when the adsorber is tested. There again a standard tracer method is fitted for use.

- Leak rate evaluation

The leak rate of iodine adsorbers is determined at present by means of a double injection of molecular iodine then methyl iodide. Comparison of the results obtained generally shows whether the efficiency is limited by leakage. However the method is long, costly and ill-suited to adsorbers containing weathered charcoal.

The use of rechargeable carbon adsorbers has led EDF to propose a test procedure based on reference samples measured every 6 months. A standardized radioactive efficiency test would be carried out on reception and after each active charcoal replacement (maximum lifetime : 4 years).

If this procedure were to be adopted, assuming the results obtained could be correlated with the findings of in-place tests, a yearly or twice-yearly check on the leak rate of the facility would be necessary in our opinion, the initial measured value being difficult to guarantee for 4 years.

For this last application a specific method must be used in keeping with the behaviour of the active charcoal.

b) Characteristics of the method

The method to be developed must meet the above 3 requirements and possess the following characteristics :

- Tracer gas. This must :
 - . be non radioactive,
 - . non inflammable,
 - . non toxic,
 - . non corrosive,
 - . non degradable,
 - . easily injectable,
 - . not affect the sorption properties of the charcoal and be quickly eliminated,
 - . stay in the active charcoal for a time consistent with leak rate measurements,
 - . not interfere with any other gases present in the effluent cleaned up.

17th DOE NUCLEAR AIR CLEANING CONFERENCE

- Detector. This must be :
 - . small and light-weight,
 - . robust,
 - . autonomous for electricity supply and gas intake (at least 10h),
 - . highly sensitive and if possible specific for the gas injected,
 - . capable of continuous tracer gas measurement,
 - . able to give a direct and rapid response.

The "tracer gas plus detector" pair must be able to measure leak rates $> 10^{-4}$ for the general working conditions of the systems tested (flow-rate, temperature, air relative humidity, moisture content of the charcoal, etc...). Such an apparatus is being studied in our laboratories.

V. Conclusions

Analysis of the results of in place tests on French facilities is not yet perfect, but certain facts emerge :

- The method used at present to measure the decontamination factor of iodine adsorbers, the only one of its kind to be covered by statutory rules, should be supplemented when necessary by other techniques allowing the leak rate of the facility in particular cases to be determined ;
- Certain additional information is necessary to improve the analysis and gain better control of the efficiency changes taking place with time in systems used only occasionally in normal operation (repairs, fuel handling, gaseous effluents treatments) ;
- No correlation has been observed, within the range of variation of these parameters, between the efficiency of iodine traps, as measured on reception and the air velocity or relative humidity ;
- Special attention must be paid to the balancing of flow-rates on systems in permanent operation and equipped with several charcoal filter trains working in parallel, otherwise the efficiency of the whole is undermined.

VI. References

1. Décret n°75.306 relatif à la Protection des Travailleurs contre les Dangers des Rayonnements Ionisants dans l'Industrie Nucléaire (1975)
2. Arrêté fixant la Périodicité des Contrôles des Installations de Ventilation (1977)
3. Premiers enseignements tirés de l'analyse de l'accident de Three Miles Island - Groupe Permanent chargé des Réacteurs Nucléaires - Ministère de l'Industrie (1979),
4. "Méthode de contrôle du coefficient d'épuration des pièges à iode"
Norme Expérimentale AFNOR NF.M.62.206 (1982)
5. Sigli P. and Trehen L.
"Contrôle des pièges à iode des centrales nucléaires"
CEC Seminar on Iodine Filter Testing - Karlsruhe (1973)
6. Deckers B., Sigli P. and Tréhen L
"Operating experience with the testing of iodine adsorbers on the air clean up systems of the Belgian PWR power plants"
14th ERDA Air Cleaning Conference CONF. 76.0822 (1976)
7. Taylor L.R. and Taylor R.
"The ageing of impregnated charcoals"
CEC Seminar on Iodine Filter Testing - Karlsruhe (1973)
8. Decoursière P.
"Evolution de la filtration des iodes dans les centrales nucléaires"
CEC Seminar on Iodine Removal from Gaseous Effluents in the Nuclear Industry - Mol (1981) - To be published
9. Madoz J.P. and Decoursière P.
"Principes de conception retenus pour assurer la fonction "piégeage des iodes" des systèmes de ventilation des réacteurs à eau légère du palier 1300 MWe"
IAEA Seminar on the Testing and Operating of Off Gas Cleaning Systems at Nuclear Facilities - Karlsruhe (1982)
To be published.

DISCUSSION

DEITZ: Does the relative humidity reach a higher value than 40 % during weathering? What is the activity of the test gas? What are the atmospheric contaminants in weathering?

MULCEY: Relative humidity can reach higher values than 40 % for the circuits which are not equipped with preheaters. Nevertheless, for the corresponding adsorbers, the humidity control performed before testing (after the 16 hours service needed for equilibrium in case of stand-by adsorbers) very rarely shows relative humidities greater than 60 %. The activity of the test gas during the injection is of the order of 10^{-7} Ci per m^3 with a maximum of about 10^{-6} Ci per m^3 in the case of deep-bed adsorbers. The injection technique used (in-place production of the radioactive tracer) does not allow the test gas activity to be constant during the injection time. The concentration of the atmospheric contaminants, partly responsible for the weathering of the charcoal (SO_2 for example) mainly depends on the industrial surroundings of the nuclear site. These contaminants have not been measured in France. For the site studied here, the values measured every 3 months show a rather good agreement with the weathering formula proposed by Taylor.

THOMAS: Do you wish to supplement the tracer method with a leak test similar to the Freon test used in the U.S.? Is 6 months the typical service life of your charcoal adsorbers? Are you required to do in-situ tracer analysis every 3 months by French law?

MULCEY: To answer your first question, I can say that this method will be similar in its principle to the U.S. one, but that the tracer gas and the detector to be used could be somewhat different. A study is starting now in our laboratory and I should be able to bring more informations in a few months. Regarding your second question, 6 months is the typical service life for continuously operating 5 cm bed depth charcoal adsorbers. As was said before, this service life is in accordance with what can be expected using Taylor's formula. French law only requires a yearly test of each ventilation system (Reference 2 of the paper). As a consequence of the T.M.I. 2 accident, safety authorities have required the licensee to perform an in-place test of the continuously operating charcoal adsorbers every 3 months. This decision only concerns some circuits of the 6 first 900 Mwe PWR'S.

DEUBER: Could you elaborate on the drawbacks of using I_2 for in-site leak testing?

MULCEY: The technique uses the well known fact that the decontamination factor of a given impregnated charcoal bed is higher for molecular iodine than for methyl iodide (generally by one order of magnitude). For new carbon, the efficiency of the adsorber is mainly governed by the leak rate of the system and a comparison between the D.F. for I_2 and ICH_3 can easily indicate a leak rate, the D.F. for I_2 being then a good estimation of the maximum leak rate of the system. For aged carbon, the overall

17th DOE NUCLEAR AIR CLEANING CONFERENCE

efficiency is also governed by the intrinsic efficiency of the carbon which can be greatly affected by ageing and weathering. Then, the leak rate estimation using the D.F. obtained for I_2 is no longer valid. This technique (rather expensive and time consuming) is then used only when a significant leak rate is anticipated from an anomalously low value obtained in a ICH_3 acceptance test.

WILHELM: The important parameter with respect to the influence of wet air is the water adsorbed on the carbon. So, a correlation between the relative humidity of the air to be filtered and the removal efficiency will only, under operational conditions during the test, give meaningful numbers when the adsorption-desorption equilibrium is reached for the water on the carbon surface.

MULCEY: I fully agree with your comment. It is the reason that we ensure that for each test performed the preconditioning time under all operational conditions (flow-rate, heating, etc...) is at least 16 hours.

17th DOE NUCLEAR AIR CLEANING CONFERENCE

IODINE FILTERING FOR FRENCH REPROCESSING PLANTS

G. Bruzzone*, J.L. Rouyer*, Ph. Mulcey*, A. Vaudano**

* Commissariat à l'Energie Atomique, IPSN/DPr/STEP/SPT, B.P. n° 6,
92260 FONTENAY AUX ROSES, France

** Commissariat à l'Energie Atomique, DERDCA/DGR/SEP, B.P. n° 6,
92260 FONTENAY AUX ROSES, France

Abstract

This paper describes the study of iodine trapping performed on a test rig called "SIRROCO" on a scale 1 cartridge filled with adsorbent AC 6120 and the tests on samples done in parallel to compare the removal efficiencies of the industrial filter with those of the sorbent. Influence of the major parameters encountered in French operating conditions are discussed. The sorbent tests have to be further pursued, particularly those concerning influence of No.

I. Introduction

Recommandations made in France for gaseous releases coming from fuel reprocessing facilities require that iodine 129 is filtered in two stages. The first stage of the removal consists of chemical primary trapping in a soda scrubber. Cleaning is finalized with secondary trapping by adsorption on a specific silver impregnated sorbent.

The requirement for this second barrier on new reprocessing plants has necessitated the selection of a feed material and the test of a filter at one-one scale in representative conditions of operation.

This paper describes the study performed on a test rig called "SIROCCO" and the tests on samples done in parallel to compare the removal efficiencies of the industrial filter with those of the sorbent and to evaluate the influence of the major parameters in French operating conditions.

II. Study on "SIROCCO" rig

II.1. Description of the experimental installations

Test were made on a cartridge filled with adsorbent AC 6120 which has been chosen because of the good removal performances described by the team of J.G. WILHELM.

Characteristics of the rig as well as of the cartridge are given in table I and figure 1.

II.2. Preparation of the experiment

To start the experiment, it has been necessary to :

- verify the representativity of upstream and downstream sample points as well as airflow measurements, by helium tracing,
- design and realize several systems with new sampling tubes in glass and teflon for the injection of iodine 127 and 131.

Table. I

FEATURES OF THE "SIROCCO" TESTING INSTALLATION

TESTING RIG

| | |
|----------------------|-------------------------|
| Nominal Flow rate | 200 N m ³ /h |
| Temperature | 150°C ± 5°C |
| Volumetric Flow rate | 310 m ³ /h |

ABSORBENT CARTRIDGE

- Geometrical parameters

| | |
|-----------------------|---------------------|
| . Shape | coaxial cylindrical |
| . Inside radius | 15,65 cm |
| . Outside radius | 28,15 cm |
| . Total height | 56 cm |
| . Useful height | 43,5 cm |
| . Absorbent bed depth | 12,5 cm |
| . Inside useful area | 0,43 m ² |
| . Outside useful area | 0,77 m ² |

- Dynamical parameters

Gas velocity

| | |
|----------------|-----------|
| . Inside face | 20,1 cm/s |
| . Outside face | 11,2 cm/s |

Average stay time

0,8 s

AC 6120 SORPTION MATERIAL

| | |
|--|----------------------|
| - Nature: impregnated amorphous silica | Ag NO ₃ |
| - Silver mass rate | 12% |
| - Apparent bulk density | 0,70 |
| - Total volume | 96,3 dm ³ |
| - Total mass | 67,4 kg |

Fig. 1

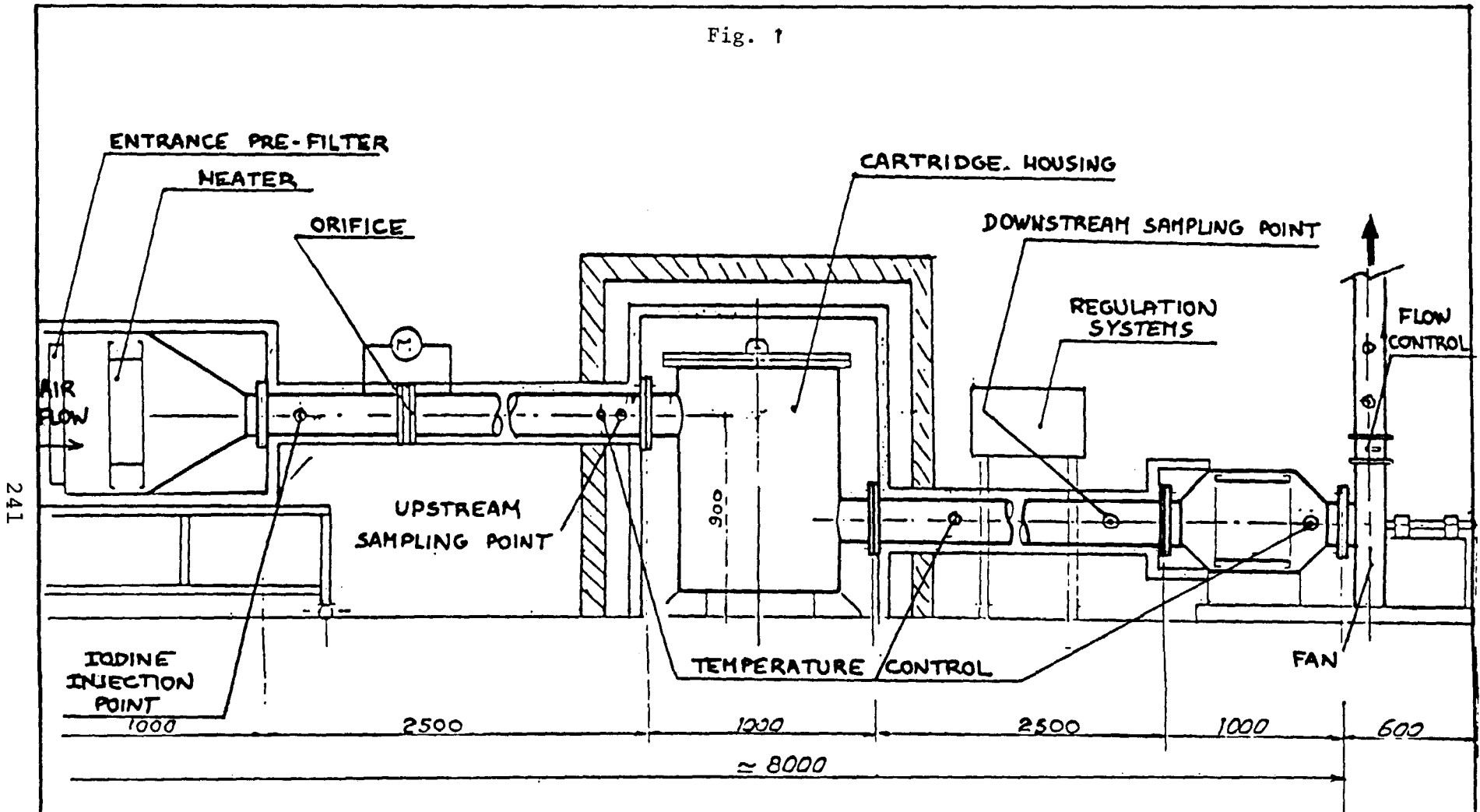

241

"SIROCCO" TEST RIG

17th DOE NUCLEAR AIR CLEANING CONFERENCE

II.3. Tests

The housing containing the cartridge is placed in an air stream at 150°C and is permanently loaded with iodine 127 vapour.

Weekly injections of molecular and methyl iodine labelled with iodine 131 were made to measure decontamination factors and follow their time-dependant evolution.

II.4. Results

- The test rig has been continuously operated for 7 560 hours with a iodine 127 loading time of 5 300 hours.

- Figures 2 and 3 show DF evolution for ICH_3 and I_2 as a function of the cartridge saturation.

Trapping efficiency of AC 6120 falls rapidly for ICH_3 above a saturation level of about 80 mg/g. For I_2 , figure 3 shows a DF decrease at a saturation level above 100 mg/g.

Two reasons could explain this apparent better behaviour of AC 6120 for molecular iodine :

- . a partial adsorption of I_2 on duct walls between the cartridge outlet and the downstream sample point (which would increase DF value in decreasing downstream activity),
- . other trapping mechanisms than those for ICH_3 .

- Data gathered for elution confirm, for ICH_3 as well as for I_2 , the degradation of cartridge removal efficiencies over a saturation level of about 85 mg/g.

II.5. Conclusion

The study realized on SIROCCO rig with AC 6120 sorbent has allowed us to :

- determine the useful parameters for filter design
- confirm the removal efficiencies at high temperature in the absence of NO_x
- obtain the values of DF which would indicate the necessity for replacement of the sorbent.

These results achieved on an industrial type installation, had to be fulfilled by laboratory tests on sorbent under all conditions representative of new French reprocessing plants.

III. Tests on sorbent samples.

The tests performed on AC 6120 samples had the following objectives :

- to reveal an eventual isotopic exchange of iodine 131 or iodine 123 with iodine 127. This exchange could occur on the rig while it cannot occur in the reprocessing plant, since the isotopic ratio between active and inactive iodine is 5 on the plant, whereas it is $5 \cdot 10^{-9}$ on the rig for iodine 131,
- to compare the saturation curve obtained for samples with the ones obtained on SIROCCO, which might indicate leakages from the filter,
- to measure the sorbent removal efficiency as a function of gas velocity,
- to study the influence of nitrogen oxides.

Fig. 2

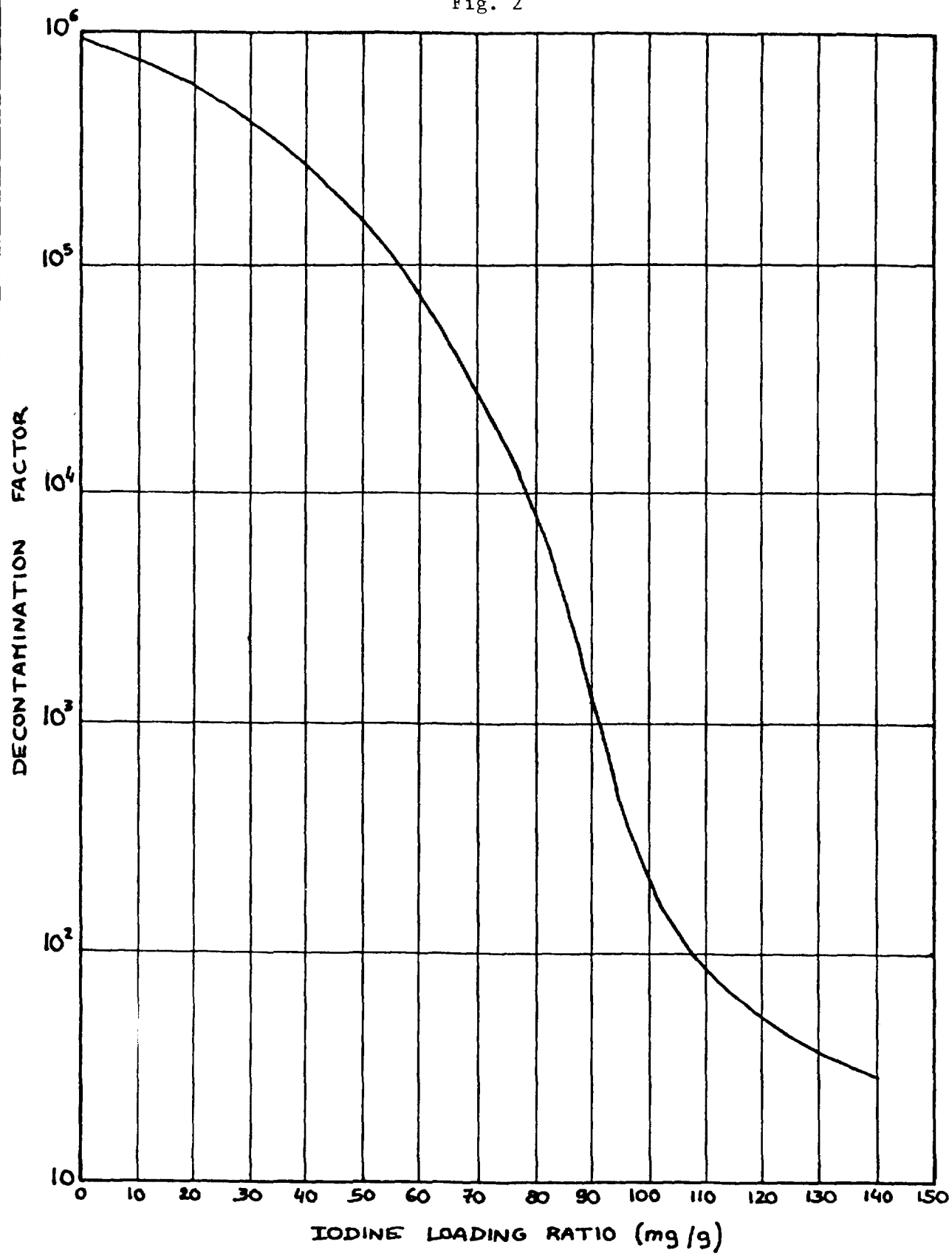

VARIATION OF DF WITH ¹²⁷IODINE LOADING FOR ¹³¹ICH₃

Fig. 3

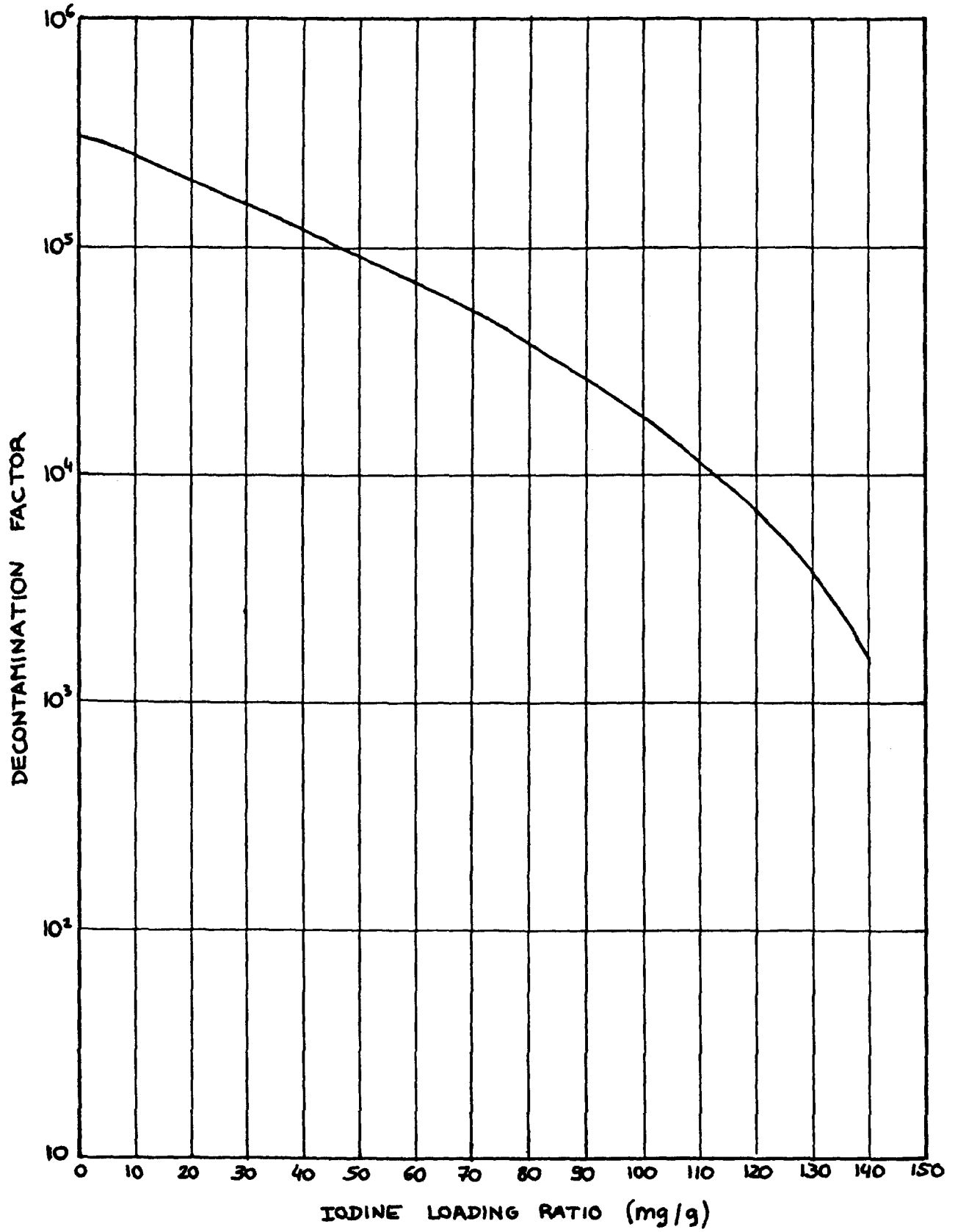

VARIATION OF DF FOR ¹³¹I₂ WITH ¹²⁷I IODINE LOADING

III.1. Estimation of isotopic exchange

The method of estimating isotopic exchange consists in DF measurement of two AC 6120 beds presaturated in molecular iodine.

This DF can be attributed to several phenomena i.e. trapping by some non saturated residual silver, iodine physical adsorption on sorbent and isotopic exchange.

The measured DF gives then an estimation at the upper limit of the isotopic exchange.

The DF values obtained and given in table II, are low : 4,5 average for molecular iodine and 1,2 average for methyl iodine.

They indicate that if it occurs, isotopic exchange is very slight. Utilization of iodine 123 or iodine 131 as a radioactive tracer is then justified.

TABLE II - Estimation of isotopic exchange

Test conditions

Sweep gas : air at 150°C, dew point : 30°C, velocity : 25 cm/s

Loading : 2 beds of AC 6120, 2.5 cm deep
 Equilibrium time of the beds : 2 h
 injection \leq 200 mg of I₂ or ICH₃ traced with I 123
 (~1 m Ci) during 1 h.
 air flow continued for 2 h.

Tests with molecular iodine

| Test | Overall DF | | Individual DF | |
|------|------------|---------|---------------|---------|
| | 1st bed | 2nd bed | 1st bed | 2nd bed |
| 1 | 4,8 | 26,4 | 4,8 | 5,5 |
| 2 | 3,7 | 15,6 | 3,7 | 4,2 |

Tests with methyl iodine

| Test | Overall DF | | Individual DF | |
|------|------------|---------|---------------|---------|
| | 1st bed | 2nd bed | 1st bed | 2nd bed |
| 3 | 1,2 | 1,5 | 1,2 | 1,2 |
| 4 | 1,2 | 1,4 | 1,2 | 1,2 |

17th DOE NUCLEAR AIR CLEANING CONFERENCE

III.2. Comparison of sorbent and filter removal efficiencies

Removal efficiencies for the cartridge of "SIROCCO" and those of sorbents with equivalent depth are comparable : efficiencies are about as high and DF drops, registered over 80 mg/g, correspond approximately to 56 % of silver consumption by iodine.

These comparable performances of the filter and the samples indicate that leakages from the filter are very low.

III.3. Removal efficiencies as a function of gas velocity

For safety of the environment, it is necessary to know the variations of removal efficiencies around normal operating conditions.

The results for several velocities are given in table III, which shows that velocities around the nominal value for the industrial trap are acceptable.

TABLE III - Removal efficiency as a function of gas velocity

Test conditions

Temperature : 150°C
 Due point : 30°C
 Air velocity : 10 to 50 cm/s
 Equilibrium time of the beds : 3 h
 Injection \leq 20 mg of ICH_3 traced with I123 (\sim /mCi)
 Air flow continued for 3^h
 5 beds of AC 6120 of 2.5 cm depth.

Results

| Test | Air velocity (cm/s) | Overall DF | | | | Individual DF | | |
|------|---------------------|------------|-------|--------|-----|---------------|-----|-----|
| | | Bed number | 1st | 2nd | 3rd | 1st | 2nd | 3rd |
| | | depth (cm) | 2,5 | 5 | 7,5 | 2,5 | 5 | 7,5 |
| 1 | 10 | | 1 900 | - | - | 1 900 | - | - |
| 2 | 25 | | 210 | 59 000 | - | 210 | 280 | - |
| 3 | 50 | | 20 | 580 | - | 20 | 29 | 28 |

III.4. Influence of nitrogen oxide

The influence of NO_2 has been extensively studied by the team of J.G. WILHELM, but information concerning NO is rather scarce. This is of concern for French reprocessing because NO/NO_2 ratio at the level of the filter is quite high.

17th DOE NUCLEAR AIR CLEANING CONFERENCE

It is possible that NO reduces impregnated silver nitrate, and thus reduces removal efficiency.

Initial tests have been carried out but the results have to be confirmed by other tests.

IV. Conclusions

The study performed on an industrial iodine filter have allowed approval for the secondary trapping for new French reprocessing plants.

To optimise the operating conditions, the study had to be completed with sorbent tests. These have to be further pursued, particularly those concerning influence of NO. A new test rig called "TEAM" will be utilized. This rig has been described in reference (2).

The placement of such a cleaning system is meant to complete the removal of iodine 129 in the gaseous effluents of reprocessing plants. This involves the development of monitors able to control periodically the removal efficiency and operate the sorbent management to obtain the best possible conditions.

V. Références

(1) G. BRUZZONE, Ph. MULCEY, J.L. ROUYER, Essais de qualification d'un dispositif de piégeage de l'iode à haute température, Séminaire sur la rétention de l'iode dans les effluents gazeux de l'industrie nucléaire, Mol, Belgique (1981)

(2) G. BRUZZONE, Ph. MULCEY, Un testeur d'échantillons d'adsorbants, Séminaire sur la rétention de l'iode dans les effluents gazeux de l'industrie nucléaire, MOL, Belgique (1981)

(3) J. FURRER, R. KAEMPFER, J.G. WILHELM, Entwicklung von abluzifiltern für Wiederaufarbeitungsanlagen, KFK 2262

DISCUSSION

THOMAS, T.R.: Are you testing AC 6120 adsorbent in the dissolver offgas of a fuel reprocessing plant? If not, when do you plan to install it in a French facility?

ROUYER: No, we made the tests under simulated conditions. UP3, the next French reprocessing facility where our iodine trap will be installed, will be started in 1987.

RETENTION OF ELEMENTAL RADIOIODINE BY DEEP BED CARBON FILTERS
UNDER ACCIDENT CONDITIONS

H. Deuber, J. G. Wilhelm
Laboratorium für Aerosolphysik und Filtertechnik
Kernforschungszentrum Karlsruhe GmbH
Postfach 3640, D-7500 Karlsruhe 1
Federal Republic of Germany

Abstract

New German guidelines require a minimum retention of elemental radioiodine of 99.99 % by the filters used to vent the annulus of pressurized water reactors in the case of a design basis accident (LOCA). On the basis of an analysis of the results from various laboratory investigations on the retention of elemental radioiodine by activated carbons it is concluded that this requirement will be met with the deep bed annulus exhaust air filters. Taking into account that the radioiodine penetrating a deep bed iodine filter is in a nonelemental form, as shown in our investigations, there even seems to be a wide safety margin.

1. Introduction

German pressurized water reactors are provided with iodine filters to vent the annulus in an accident (1). According to new guidelines the minimum retention to be achieved with these filters in a design basis accident (LOCA) is 99.99 % for elemental radioiodine (2). The corresponding value for organic radioiodine (which has not been raised) is 99 %.

We have concluded that in the event of a LOCA this new requirement will be met with the deep bed annulus exhaust air filters, both with respect to the performance of the activated carbon and the leaktightness. That the leaktightness of the filters is sufficient can be inferred from surveillance tests (3,4). That also the performance of the activated carbon contained in the filters suffices can be concluded from an evaluation of the results of laboratory investigations on the retention of elemental radioiodine by activated carbons. In this paper we present this evaluation in which both results of studies described in the literature and of studies recently performed in our laboratory have been taken into account.

2. Design and operation of accident filters

As already indicated, in German PWRs annulus exhaust air filters containing activated carbon are installed to mitigate the consequences of an accident. Mostly the activated carbon 207B, 8 - 12 mesh, impregnated with KI, is used. Bed depth and face velocity are about 50 cm and 50 cm/s, respectively (residence time: ≈ 1 s) (3,4).

During normal situations the filters have to be in the stand-by mode. During an accident the filters can be challenged by leakage of steam and radioactivity as well as transfer of heat through the inner containment shell. However, during a LOCA the effect of leakage can be neglected even if the design basis leakage (0.25 %/d) is exceeded to a certain extent.

Therefore, in a LOCA temperatures and relative humidities of < 150 °C and < 10 %, respectively, have to be anticipated in the annulus during the major part of the first phase of the accident in which a pressure differential across the inner containment shell exists. The length of this phase may be of the order of 10 h. Afterwards, temperatures and relative humidities near to 30 °C and 100 %, respectively, have to be envisaged. Filter operation under these conditions could last up to two months.

As regards the iodine concentration in the inlet air of the annulus exhaust air filters and the iodine loading of the carbon, values of < 1 mg I/m³ and < 1 mg I/g carbon, respectively, have to be reckoned with.

From data pertaining to serious accidents (5) it can be concluded that, if the integrity of the inner containment shell were maintained, in serious accidents the challenge of the annulus exhaust air filters would not be much more serious than that outlined above.

3. Results of previous investigations

This chapter contains results which various experimenters obtained in investigations on the retention of elemental radioiodine by activated carbons. To a certain extent these results have already been reviewed a few years ago (1,6).

In these investigations a small bed depth or residence time was used in general (2.5 to 5 cm and 0.1 to 0.2 s, respectively). In addition, the purging time was often short (several h). The retention test according to ASTM D3803 (7) is a typical example. In this test, performed at 180 °C, the bed depth and residence time are about 2.5 cm and 0.13 s, respectively; the purging time is 4 h. It seems that attempts to establish the chemical form of penetrating radioiodine have rarely been made.

In this review both the influence of various parameters on the retention of radioiodine and the chemical form of penetrating radioiodine are dealt with. Emphasis is placed on studies performed under conditions which are of importance in the present context.

3.1 Influence of various parameters on the retention of elemental radioiodine

Base material

It was observed by Caron et al. (8) that up to some 150 °C the base material exerts no significant influence. The decontamination factors (DF's) found with coconut and coal carbon were 10^5 to 10^6 (impregnant: none, KI or TEDA; dry air; residence time: 0.17s; purging time: several h). However, at higher temperatures, coconut carbon was ascertained to perform best in general (9,8,10,11). This finding has been attributed to the high potassium content and high basicity of coconut carbon. It has been concluded that, in addition to physical adsorption, formation of KI is of importance in the retention of elemental iodine by carbons (11).

Particle size

The retention of I_2 decreases with increasing particle size of the carbon. This may be explained by longer diffusion time with higher particle size. We have observed a decrease of DF from between 10^5 and 10^6 to 10^4 with increase of particle size from 8 - 12 to 5 - 10 mesh (207B (KI); 30 °C; 98 - 100 % R. H.; residence time: 0.1 s; purging time: 2 h). In other experiments the particle size was varied from 16 - 32 to 2 - 4 mesh (12). The DF's always exceeded the maximum measurable value of 10^4 (BC727 (KI); 25 °C; 25 % R. H.; residence time: \approx 0.13 s; purging time: \approx 3 h).

Impregnant

Up to some 150 °C the influence of the impregnant is not significant in dry air as can be seen from the DF's of between 10^5 to 10^6 found by Caron et al. (8) for carbons impregnated with KI, TEDA or not impregnated, under the conditions mentioned above. In these experiments the same was observed for humid air at ambient temperature except for a low DF for carbons without impregnants. The last finding can be attributed to poorer retention of organic iodine species formed from I_2 . We have obtained similar results in humid air at 30 °C (13). At temperatures higher than 150 °C both insignificant and significant (detrimental) influence of impregnants have been noticed (8,10).

Service life

Various authors have reported on the decline of DF due to aging (14-18,4). We have observed a decrease of DF by two orders of magnitude due to aging in a nuclear power station for one year (wood carbon impregnated with KI₃; 30 °C; 40 % R. H.; residence time: 0.1 s, purging time: 2 h or 2 weeks) (4). By purging for two weeks the DF of the aged carbon was diminished to between 10^3 and 10^4 . A similar decrease of DF was observed in other

cases for the same length of aging (18). The DF fell to between 10^2 and 10^3 over one year of service (coconut carbons impregnated with KI and TEDA, 180 °C, dry air, residence time: ~ 0.1 s; purging time: 4 h). In these cases the decrease of DF could be correlated to the decrease of pH of the water extract of the carbon.

I₂ concentration

With a rise of the I₂ concentration to values much higher than 1 mg/m³ a fall of DF has been observed (19,20). This can be attributed to exceeding of the loading capacity which is approximately 1 mg I/g carbon. However, the DF may also drop if the I₂ concentration declines to values much lower than 1 mg/m³ (21,19,20). This performance has not to be expected from theoretical considerations (22). It may therefore be assumed that the effect is caused by the formation of more penetrating iodine species whose proportions increase with decreasing I₂ concentration.

Temperature

Because a high temperature is not favorable for physical adsorption a decrease of DF with increase of temperature has to be expected. This effect has been found to be very dependent on the purging time. At a purging time of several hours, Caron et al. (8) found no significant influence up to a temperature of some 150 °C (carbon: coconut or coal; impregnant: KI, TEDA or none; dry air; residence time: 0.17 s). However, at a purging time of approximately one week, the DF dropped from between 10^5 and 10^6 to between 10^3 and 10^4 at the same conditions. Insignificant influence of temperature up to nearly 150 °C in dry and humid air has been noticed by various investigators when the purging time was kept short (23,21,24,25,19,8).

Relative humidity

With impregnated carbons ordinarily little influence of the relative humidity on the retention of I₂ has been observed (25,19,8,26,27). Even with water-clogged carbon a good retention was noticed (25,19). However, with unimpregnated carbons a decrease of DF with increase of relative humidity was found (21,8,27). This may be attributed to the formation of other iodine species which are difficult to trap with unimpregnated carbons in humid air.

Face velocity

At the same residence time the influence of the face velocity appears to be negligible in a wide range. We have found the same DF's of between 10^5 and 10^6 at 25 and 50 cm/s (carbon: 207B; impregnant: KI or TEDA; 30 °C, 98 - 100 % R. H.; residence time: 0.1s; purging time: 2 h).

Residence time

In accord with expectation, an increase of DF with increase of residence time has been found (21,28,1,3,4,13). However, when the residence time becomes longer than about 0.1 s, the increase usually becomes relatively small. This has to be ascribed to the

formation of more penetrating iodine species whose influence becomes evident when the bulk of elemental iodine has been removed. With aged carbons this may occur at a residence time much higher than 0.1 s (3).

Purging time

With extended purging iodine may desorb from the carbon. This effect depends strongly on temperature. With impregnated carbons usually little influence has been noticed at ambient temperature in dry and humid air (8,27). However, with a certain carbon (wood carbon impregnated with KI_3) we observed a marked effect even at a low temperature (4). If the temperature approaches 150 °C the effect becomes very pronounced. In the experiments of Caron et al. (8) the DF was mostly lower than 10^4 at 150 °C at a purging time of approximately one week (carbon: coconut or coal; impregnant: KI, TEDA or none; dry air; residence time: 0.17 s).

Radiation

Intense gamma radiation may significantly influence the DF. In a radiation field of about 10^7 rad/h, Evans (10) mostly found DF's of between 10^3 and 10^4 , compared with DF's of greater than or equal to 10^5 with no radiation at all (various impregnated carbons; 80 °C; 75 % R. H.; residence time: \approx 0.1 s; purging time: 4h). These values translate to a desorption rate of the order of 10^{-4} %/h. With no impregnation desorption was even stronger. The influence of radiation was due to generation of organics (see Sec. 3.2). Lorenz (29,30) investigated the influence of radiation (and heat) by loading highly radioactive iodine on carbon (up to about 10^3 Ci ^{130}I equivalent to about 10^8 rad/h). The desorption rate of radioiodine was of the order of 10^{-4} to 10^{-3} %/h.

The influence of the various parameters on the retention of elemental radioiodine by impregnated activated carbons, in the range of interest in the present context, is summarized in Table I. It is obvious that the critical parameters are service life, temperature, purging time and radiation. With unfavorable values of these parameters, in the range of interest here, there is a potential that a DF of 10^4 is not achieved if the residence time is in the range of 0.1 to 0.2 s only.

3.2 Chemical form of penetrating radioiodine

Because only small amounts of radioiodine usually desorb from carbons it is not easy to determine the chemical iodine species involved.

Evans (10) succeeded in identifying four organic iodine species which desorbed from the carbon when an intense radiation field was applied. These were methyl iodide, methylene iodide, ethyl iodide and vinyl iodide.

Other investigators have tried to distinguish elemental and organic iodine by passing the desorbing iodine through samplers with components for selective retention. Lorenz et al. (29,30)

employed silver plated honeycombs to selectively trap I_2 desorbing from the carbon loaded with highly radioactive iodine. Mostly they found small percentages of I_2 only, particularly in the experiments with humid air.

Caron et al. (8) collected I_2 with copper screens. Often they observed an abundance of I_2 in their desorption tests (carbon: coconut and coal; impregnant: KI, TEDA, none; 200 °C; dry air; residence time: \approx 0.17 s; purging time: up to about 1 week).

We usually trap I_2 on a specific sorbent (DSM11; see appendix). In desorption tests we did not find measurable percentages of I_2 (carbon: wood; impregnant: KI₃; 30 °C; 40 % R. H.; residence time (total): 0.35 s; purging time: 2 weeks) (4).

4. Results of recent investigations

In this chapter results are given which we obtained in recent investigations on the retention of elemental radioiodine by activated carbons. The aim of these studies was to more realistically determine the retention of elemental radioiodine to be expected with the deep bed annulus exhaust air filters of a PWR in the case of a LOCA. In particular, these studies aimed at assessing the safety margin to be anticipated.

Investigations with four activated carbons are dealt with here. Data on these carbons are given in Table II. As can be seen, carbons of different base materials and different impregnants were used. The first two carbons (207B (KI) and 207B (TEDA)) have been on the market for several years. The other two carbons (Kiteg II and Radshield 25) have been developed in recent years.

Other relevant experimental data are presented in Table III and in the appendix. As can be seen from Table III two combinations of temperature and relative humidity were employed: (a) 30 °C and 98 to 100 % R. H. and (b) 130 °C and 2 % R. H.. The second combination may be regarded to conservatively represent the conditions in the annulus of a PWR during the first phase of a LOCA and the first combination the conditions thereafter (see Sec. 2.).

Total test bed depth and residence time (25 cm and 0.5 s, respectively) were shorter than those mostly used in the annulus exhaust air filters (50 cm and 1.0 s, respectively). The test bed was sectioned to establish retention or penetration as a function of bed depth or residence time and to facilitate analysis of the iodine species involved.

Purging time (after end of loading) was 2 h or 1 week (168 h).

In the following sections first the influence of various parameters on retention of elemental radioiodine, than the chemical form of penetrating radioiodine are covered.

4.1 Influence of various parameters on the retention of elemental radioiodine

The results are presented in terms of retention in Tables IV to VII and in terms of penetration in Figs. 1 to 8. The following discussion will be mainly based on Figs. 1 to 8. It should be borne in mind that in these penetration profiles the steep part has to be ascribed to elemental iodine and the flat part to more penetrating iodine species present as impurities or formed in the test bed.

The penetration of the carbon 207B impregnated with KI by ^{131}I loaded as I_2 at different purging times and at different temperatures is given in Figs. 1 and 2. As regards the penetration at 30 °C (Fig. 1), at a purging time of 2 h there is a strong decrease with increasing bed depth. The detection limit corresponding to a penetration of $10^{-5}\%$ is reached at a bed depth of 7.5 cm (residence time of 0.15 s). At a purging time of 168 h there is practically the same decrease of penetration up to a bed depth of 3.75 cm. Then the penetration curve levels off. A penetration of about $10^{-4}\%$ is reached at a bed depth of 25 cm (residence time of 0.5 s).

At 130 °C the penetration of 207B (KI) is as follows (Fig. 2): At a purging time of 2 h the penetration is similar to the corresponding penetration at 30 °C. However, at a purging time of 168 h the penetration is much higher at short bed depths. There is a difference of partly more than one order of magnitude compared with the corresponding penetration at 30 °C. For the long purging time the penetration found at larger bed depths is little different from the corresponding penetration at 30 °C.

The penetration of 207B (TEDA) is shown in Figs. 3 and 4. At 30 °C (Fig. 3) there is little difference in the values obtained for different purging times. Both penetration curves, initially very steep, level off at a bed depth of 3.75 cm. At a bed depth of 25 cm the penetration is equal to or less than $10^{-4}\%$.

At 130 °C the penetration of 207B (TEDA) can be described as follows (Fig. 4): It is similar to the corresponding penetration at 30 °C in the case of the short purging time. However, in the case of the long purging time the penetration is much higher, both at small and large bed depths. There is a difference of up to two orders of magnitude compared with the corresponding penetration at 30 °C.

The penetration profiles found with Kiteg II (Figs. 5 and 6) are rather similar to those found with 207B (KI), both qualitatively and quantitatively. A notable difference is the relatively small slope of the penetration curve at higher bed depths in the case of the low temperature and the low purging time.

As regards the penetration profiles obtained with Radshield 25 (Fig. 7 and 8), they are also rather similar to those obtained with 207B (KI). The slope of the penetration curve at higher bed depths in the case of the low temperature and the low purging time is relatively small, similar to that observed with Kiteg II.

A summary of the penetration values for the four carbons investigated is given in Table VIII. Values for bed depths of 5 cm and 25 cm are presented. The former may be largely attributed to elemental iodine, the latter to more penetrating iodine species.

As regards the penetration values for a bed depth of 5 cm, at 30 °C they are similar for all carbons at the same purging time. However, the influence of purging is minimal at this temperature. (This is more obvious if values for bed depths of smaller than 5 cm are compared.) At 130 °C there is a wide scatter of the values at the same purging time. However, those for 207B (KI), Kiteg II and Radshield 25 are relatively similar compared with those for 207B (TEDA). The latter are at least one order of magnitude higher than the former. The influence of purging is pronounced with all carbons at 130 °C. The penetration increases by roughly two orders of magnitude over one week of purging.

The penetration values for a bed depth of 5 cm show also that at the small purging time there is little influence of the temperature (and relative humidity). Except for 207B (TEDA), even somewhat smaller values have been found at the higher temperature.

As regards the penetration values for a bed depth of 25 cm, those for 207B (KI), Kiteg II and Radshield 25 are similar and generally much lower than those for 207B (TEDA).

Our data show that the performance of 207B (TEDA) is relatively poor with respect to retention of elemental iodine at elevated temperature and extended purging. It appears that this peculiar behavior, attributable to the TEDA impregnant, has not been reported in the literature.

207B (TEDA) exempted, our data compare favorably with literature data if retention of elemental radioiodine by new activated carbons in the same range of parameters is considered (see Table I):

- (a) There is no significant influence of the type of carbon (base material, impregnant).
- (b) Temperature and purging time exert a detrimental influence if they are raised simultaneously.

Our results also confirm that even with new activated carbons there is a potential that under unfavorable conditions, in the range of interest in this context, a DF of 10^4 for elemental radioiodine is not achieved if the residence time is in the range of 0.1 to 0.2 s only. However, our results demonstrate that at a higher residence time there is no such a potential with suitable new activated carbons.

The influence of aging is being assessed in supplementary studies although no dramatic effect is anticipated with a high residence time.

4.2 Chemical form of penetrating radioiodine

As described in the appendix, in the tests with long purging the normal back-up beds (207B (KI)) were preceded by other components to determine the percentages of particulates (particulate filter), of I₂ (sorbent DSM11) and of organic species relatively easy to trap such as CH₃I (sorbent AC 6120).

The distribution of ¹³¹I among test and back-up beds in the long purging runs is displayed in Figs. 9 to 12. The particulate filters have not been indicated because in no case was any ¹³¹I detected on these components.

The ¹³¹I distribution found in the long purging runs in which 207B (KI) was tested is shown in Fig. 9. As regards the back-up beds, at 30 °C ¹³¹I was found on the first AC 6120 bed, at 130 °C on both AC 6120 beds. No ¹³¹I was detected on the other back-up beds.

The ¹³¹I distribution in the tests with 207B (TEDA) is shown in Fig. 10. At 30 °C the distribution in the back up beds was similar to that in the corresponding test with 207B (KI). Only the first AC 6120 bed contained ¹³¹I. However, at 130 °C the distribution was very different. ¹³¹I was found on all the back-up beds, except for DSM11.

The ¹³¹I distribution in the tests with Kiteg II and Radshield 25 is given in Figs. 11 and 12. The distribution in the back-up beds was largely similar to that in the tests with 207B (KI).

From the fact that no ¹³¹I was detected on the back-up component DSM11 in any of the tests, it has to be concluded that only nonelemental ¹³¹I penetrated the carbon beds. This is in agreement with the penetration profiles shown in Figs. 1 to 8. The nonelemental ¹³¹I was mostly easy to retain on AC 6120. However, in the high temperature test with 207B (TEDA) it was highly penetrating.

The above results on the chemical form of iodine desorbing from the test beds are in agreement with the results of our previous investigations (4) described in Sec. 3.2. They differ from the results of Caron et al. (8) who found high portions of I₂ desorbing from the test beds as mentioned in Sec. 3.2. This difference may be attributed to the fact that in the tests of Caron et al. the temperature was higher and the residence time shorter.

5. Summary

New German guidelines require a minimum retention of elemental radioiodine of 99.99 % by the filters used to vent the annulus of pressurized water reactors in the case of a design basis accident (LOCA).

17th DOE NUCLEAR AIR CLEANING CONFERENCE

Studies of various experimenters on the retention of elemental radioiodine by activated carbons, performed mostly with a residence time of between 0.1 and 0.2 s, reveal that with shallow beds there is a potential that a retention of 99.99 % is not achieved in the range of conditions of interest in this context (Table I). However, our investigations demonstrate that at a higher residence time there is no such a potential with suitable new activated carbons (Table VIII). We are conducting supplementary studies on the influence of aging although we do not expect a dramatic effect with a high residence time.

On the basis of the results so far available on the retention of elemental radioiodine by activated carbons it is therefore concluded that the requirement mentioned above will be met with the deep bed annulus exhaust air filters. Taking into account that the radioiodine penetrating a deep bed iodine filter is in a non-elemental form, there even seems to be a wide safety margin.

The work was supported by the Minister of the Interior of the Federal Republic of Germany.

K. Bleier, W. Sellien, S. Winkler, H. Fischer and A. Ladanyi participated in the performance and evaluation of the tests.

17th DOE NUCLEAR AIR CLEANING CONFERENCE

6. References

- (1) Wilhelm, J. G.,
"Iodine filters in nuclear power stations,"
KFK 2449 (1977)
- (2) Reaktor-Sicherheitskommission,
"RSK-Leitlinien für Druckwasserreaktoren"(1981)
- (3) Wilhelm, J. G. et al.,
"Behavior of gasketless deep bed charcoal filters
for radioiodine removal in LWR power plants,"
16th DOE Nuclear Air Cleaning Conference,
CONF - 801 038, p. 465
- (4) Wilhelm, J. G. et al.,
"Operational experience with iodine filters at German LWRs,"
CEC Seminar on Iodine Removal from Gaseous Effluents
in the Nuclear Industry, Mol, 21 - 24 Sept. 1981
- (5) Dillmann, H.-G., Pasler, H.,
"Theoretical and experimental investigations into the
filtration of the atmosphere within the containments of
pressurized water reactors after serious reactor accidents,"
16th DOE Nuclear Air Cleaning Conference,
CONF - 801 038, p. 373
- (6) Holladay, D. W.,
"A literature survey: methods for the removal of iodine
species from off-gases and liquid waste streams of nuclear
power and nuclear fuel reprocessing plants, with emphasis
on solid sorbents,"
ORNL/TM - 6350 (1979)
- (7) American Society for Testing and Materials,
"Standard test methods for radioiodine testing
of nuclear-grade gas-phase adsorbents,"
ASTM D3803 (1979)
- (8) Caron, J. et al.,
"Piégeage de l'iode et de l'iodure de méthyle
a temperature élevée,"
Congrès international sur la diffusion des produits
de fission, Saclay, 4 - 6 Nov. 1969, p. 285
- (9) Lingjaerde, R. O., Podo, L.,
"A study on the trapping of iodine at high temperatures
on activated charcoal,"
DP - 213 (1963)

17th DOE NUCLEAR AIR CLEANING CONFERENCE

- (10) Evans, A. G.,
"Effect of intense gamma radiation on radioiodine retention by activated carbon,"
12th AEC Air Cleaning Conference,
CONF - 720 823, p. 401
- (11) Evans, A. G.,
"Effect of alkali metal content of carbon on retention of iodine at high temperatures,"
13th AEC Air Cleaning Conference,
CONF - 740 807, p. 743
- (12) Bellamy, R. R.,
"Elemental iodine and methyl iodide adsorption on activated charcoal at low concentrations,"
13th AEC Air Cleaning Conference,
CONF - 740 807, p. 683
- (13) Deuber, H.,
"Aspects of retention and differentiation of gaseous radioiodine species,"
Paper presented at the Boris Kidrič Institute of Nuclear Sciences,
Belgrade, 1981
- (14) Milham, R. C.,
"High temperature properties of activated carbon:
Part I: Desorption of iodine;
Part II: Standard method for ignition temperature measurement,"
IAEA Symposium on Treatment of Airborne Radioactive Wastes,
New York, 26 - 30 Aug. 1968,
STI/PUB/195, p. 417
- (15) Milham, R. C.,
"Charcoal post treatment; heat degradation and service life,"
10th AEC Air Cleaning Conference,
CONF - 680 821, p. 167
- (16) Evans, A. G.,
"Effect of service on retention of iodine by activated carbon,"
11th AEC Air Cleaning Conference,
CONF - 700 816, p. 539
- (17) Bennet, E. C., Strege, D. E.,
"Evaluation of weathered impregnated charcoals for retention of iodine and methyl iodide,"
UNI - 39 (1973)

17th DOE NUCLEAR AIR CLEANING CONFERENCE

- (18) Evans, A. G.,
"Effect of service aging on iodine retention of
activated charcoals,"
14th ERDA Air Cleaning Conference,
CONF - 760 822, p. 251

- (19) Adams, R. E. et al.,
"Application of impregnated charcoals for removing
radioiodine from flowing air at high relative humidity,"
IAEA Symposium on Treatment of Airborne Radioactive Wastes,
New York, 26 - 30 Aug. 1968, STI/PUB/195, p. 387

- (20) Adams, R. E. et al.,
"Trapping of radioactive iodine and methyl iodide
by impregnated charcoals,"
Nuclear Safety Program Annual Progress Report for
Period Ending December 31, 1968,
ORNL - 4374 (1969), p. 93

- (21) Billard, F. et al.,
"The influence of physical parameters on the adsorption
of iodine 131 by activated charcoals,"
International Symposium on Fission Product Release
and Transport, Oak Ridge, 5 - 7 April 1965,
CONF - 650 407, p. 814

- (22) Ritzman, R. L., Genco, J. M.,
"Evaluation of data regarding the efficiency of
activated charcoal adsorbers at low gas phase
iodine concentration,"
WASH - 1231 (1972)

- (23) Adams, R. E., Browning, W. E.,
"Removal of iodine from gas streams,"
7th AEC Air Cleaning Conference, TID - 7627, p. 242

- (24) Adams, R. E. et al.,
"Removal of radioactive methyl iodide from steam air systems,"
ORNL - 4040 (1967)

- (25) Adams, R. E., Ackley, R. D.,
"Removal of elemental radioiodine from flowing
humid air by iodized charcoals,"
ORNL - TM - 2040 (1967)

- (26) Ludwick, J. D.,
" The iodine collection efficiency of activated
charcoal from Hanford reactor confinement systems:
methyl iodide retention by activated charcoal,"
BNWL - 1046 (1969)

17th DOE NUCLEAR AIR CLEANING CONFERENCE

- (27) Davis, R. J., Ackley, R. D.,
"Long-term effects on radioiodine trapping by charcoal,"
12th AEC Air Cleaning Conference,
CONF - 720 823, p. 469
- (28) Kovach, J. L., Newton, R. G.,
"Deep bed activated carbon for liquid, solid,
aerosol and gaseous filters,"
11th AEC Air Cleaning Conference,
CONF - 700 816, p. 738
- (29) Lorenz, R. A. et al.,
"The behavior of highly radioactive iodine on charcoal,"
13th AEC Air Cleaning Conference,
CONF - 740 807, p. 707
- (30) Lorenz, R. A. et al.,
"The behavior of highly radioactive iodine on
charcoal in moist air,"
14th ERDA Air Cleaning Conference,
CONF - 760 822, p. 323
- (31) Deuber, H., Wilhelm, J. G.,
"Determination of the physico-chemical ^{131}I species
in the exhausts and stack effluent of a PWR power plant,"
15th DOE Nuclear Air Cleaning Conference,
CONF - 780 819, p. 446
- (32) Deuber, H., Wilhelm, J. G.,
"Occurrence of penetrating iodine species in the
exhaust air of PWR power plants,"
16th DOE Nuclear Air Cleaning Conference,
CONF - 801 038, p. 1354
- (33) Wilhelm, J. G.,
"Testing iodine filters for nuclear installations,"
IAEA Symposium on Treatment of Airborne Radioactive Wastes,
New York, 26 - 30 Aug. 1968,
STI/PUB/195, p. 403.

7. Appendix: Experimental

Relevant experimental data of our investigations on the retention of elemental radioiodine by activated carbons are given in Table III. The reasons for the choice of the parameters are dealt with in the text.

As indicated in Table III, ten successive test beds of a depth of 2.5 cm each were used the first two of which consisted of sections of a depth of 1.25 cm each.

As regards the back-up beds, in the tests with long purging the normal back-up beds (207B (KI)) were preceded by other components to allow differentiation of the iodine species penetrating the test beds. These components were (in direction of flow):

- 1 particulate filter;
- 2 beds of sorbent DSM11 for retention of I_2 ;
- 2 beds of sorbent AC 6120 for retention of organic species that are relatively easy to trap, such as CH_3I .

Details on the performance of these sorbents have been reported in the literature (31,32).

All the back-up beds were maintained at a temperature which was favorable for trapping the iodine species (80 °C). All the back-up beds had a depth of 2.5 cm corresponding to a residence time of 0.05 s.

(33,1) The investigations were performed with our standard test rig. The elemental iodine was tagged with ^{131}I . The detection limit for ^{131}I , measured with a NaI(Tl) detector, was 10^{-11} Ci per bed (100 % error at the 3σ confidence level). Total activities of greater than or equal to 10^{-4} Ci ^{131}I were used. These values correspond to a minimum detectable penetration of 10^{-5} %.

Table I Influence of various parameters on the retention of I₂ by impregnated activated carbons according to literature (temperature ≤ 150 °C)

| Parameter | Change of DF with change or increase of parameter | Remarks ^{a)} |
|------------------------------|---|--|
| Base material | Not significant | |
| Particle size | Decrease | DF ≈ 10 ⁴ reported |
| Impregnant | Not significant | |
| Service life | Decrease | DF < 10 ⁴ reported |
| I ₂ concentration | Possibly significant | Formation of other I species; exceeding of loading capacity |
| Temperature | Decrease | At long ₄ purging time; DF < 10 ⁴ reported |
| Rel. humidity | Not significant | |
| Face velocity | Not significant | At same residence time |
| Residence time | Increase | |
| Purging time | Decrease | At high temperature; DF < 10 ⁴ reported |
| Radiation | Decrease | Formation of other I species; DF < 10 ⁴ reported |

a) DF's: minimum values at residence times of between 0.1 and 0.2 s

17th DOE NUCLEAR AIR CLEANING CONFERENCE

Table II Activated carbons investigated

| Designation | Base material | Particle size (mesh) | Impreg-nant | Supplier |
|--------------|---------------|----------------------|----------------------------------|-------------------------------------|
| 207B (KI) | coal | 8 - 12 ^{a)} | KI | Sutcliffe Speakman, U.K. |
| 207B (TEDA) | coal | 8 - 12 ^{a)} | TEDA | Sutcliffe Speakman, U.K. |
| Kiteg II | coconut shell | 8 - 16 ^{b)} | KI, tertiary amine ^{c)} | Nuclear Consulting Services, U.S.A. |
| Radshield 25 | coconut shell | 8 - 16 ^{b)} | tertiary amine | Charcoal Engineering, U.S.A. |

a) BSS 410

b) ASTM D2862

c) additionally buffer and antioxidant

Table III Values of test parameters

| Parameter | Unit | Value |
|------------------------------------|-------------------|---------------|
| Carrier concentration | mg/m ³ | 1 |
| Temperature | °C | 30 or 130 |
| Relative humidity ^{a)} | % | 98 - 100 or 2 |
| Face velocity | cm/s | 50 |
| Pressure (absolute) | bar | 1 |
| Bed depth ^{b)} | cm | 2.5 |
| Residence time per bed | s | 0.05 |
| Preconditioning time ^{c)} | h | ≥ 16 or 1 |
| Injection time | h | 1 |
| Purging time | h | 2 or 168 |

a) 98 - 100 % at 30 °C; 2 % at 130 °C (dew point : 30 °C)

b) Ten successive test beds of depth 2.5 cm were used. The first two test beds consisted of sections of depth 1.25 cm. Details of the back-up beds are given in the appendix. (Diameter of all beds: 2.5 cm)

c) ≥ 16 h at 30 °C; 1 h at 130 °C.

Table IV Retention of ^{131}I loaded as I_2 by 207B (KI) ^{a)}

| Bed depth (cm) | Residence time (s) | Retention (%) | | | |
|-------------------|-----------------------|-------------------------|---------------------|----------------------|---------------------|
| | | 30 °C, 98 - 100 % R. H. | | 130 °C, 2 % R. H. | |
| | | 2 h ^{b),c)} | 168 h ^{b)} | 2 h ^{b),c)} | 168 h ^{b)} |
| 2.5 | 0.05 | 99.930 | 99.971 | 99.9908 | 99.42 |
| 5.0 | 0.10 | 99.99935 | 99.9973 | 99.99985 | 99.9970 |
| 7.5 | 0.15 | 99.99999 | 99.99911 | 99.99997 | 99.99900 |
| 10.0 | 0.20 | - | 99.99957 | - | 99.99946 |
| 12.5 | 0.25 | - | 99.99972 | - | 99.99958 |
| 15.0 | 0.30 | - | 99.99977 | - | 99.99964 |
| 17.5 | 0.35 | - | 99.99981 | - | 99.99971 |
| 20.0 | 0.40 | - | 99.99984 | - | 99.99976 |
| 22.5 | 0.45 | - | 99.99986 | - | 99.99978 |
| 25.0 | 0.50 | - | 99.99988 | - | 99.99981 |

a) Values of additional parameters: see Table III

b) Purging time

c) - : Retention higher than maximum detectable retention (99.99999 %)

Table V Retention of ^{131}I loaded as I_2 by 207B (TEDA) a)

| Bed depth (cm) | Residence time (s) | Retention (%) | | | |
|-------------------|-----------------------|-------------------------|---------------------|-------------------|---------------------|
| | | 30 °C, 98 - 100 % R. H. | | 130 °C, 2 % R. H. | |
| | | 2 h ^{b)} | 168 h ^{b)} | 2 h ^{b)} | 168 h ^{b)} |
| 2.5 | 0.05 | 99.925 | 99.933 | 99.942 | 96.0 |
| 5.0 | 0.10 | 99.99948 | 99.9985 | 99.9982 | 99.62 |
| 7.5 | 0.15 | 99.99969 | 99.99931 | 99.99952 | 99.979 |
| 10.0 | 0.20 | 99.99977 | 99.99955 | 99.99965 | 99.9918 |
| 12.5 | 0.25 | 99.99982 | 99.99966 | 99.99973 | 99.9938 |
| 15.0 | 0.30 | 99.99987 | 99.99973 | 99.99978 | 99.9947 |
| 17.5 | 0.35 | 99.99990 | 99.99979 | 99.99982 | 99.9953 |
| 20.0 | 0.40 | 99.99993 | 99.99983 | 99.99985 | 99.9957 |
| 22.5 | 0.45 | 99.99995 | 99.99986 | 99.99987 | 99.9960 |
| 25.0 | 0.50 | 99.99996 | 99.99988 | 99.99988 | 99.9963 |

a) Values of additional parameters: see Table III

b) Purging time

Table VI Retention of ^{131}I loaded as I_2 by Kiteg II ^{a)}

| Bed depth (cm) | Residence time (s) | Retention (%) | | | |
|-------------------|-----------------------|-------------------------|---------------------|-----------------------|---------------------|
| | | 30 °C, 98 - 100 % R. H. | | 130 °C, 2 % R. H. | |
| | | 2 h ^{b), c)} | 168 h ^{b)} | 2 h ^{b), c)} | 168 h ^{b)} |
| 2.5 | 0.05 | 99.988 | 99.976 | 99.969 | 98.9 |
| 5.0 | 0.10 | 99.99977 | 99.9976 | 99.99993 | 99.957 |
| 7.5 | 0.15 | 99.99989 | 99.9985 | - | 99.9981 |
| 10.0 | 0.20 | 99.99994 | 99.99905 | - | 99.9988 |
| 12.5 | 0.25 | 99.99996 | 99.99935 | - | 99.99909 |
| 15.0 | 0.30 | 99.99996 | 99.99953 | - | 99.99924 |
| 17.5 | 0.35 | 99.99998 | 99.99965 | - | 99.99935 |
| 20.0 | 0.40 | - | 99.99972 | - | 99.99944 |
| 22.5 | 0.45 | - | 99.99977 | - | 99.99950 |
| 25.0 | 0.50 | - | 99.99981 | - | 99.99956 |

a) Values of additional parameters: see Table III

b) Purging time

c) - : Retention higher than maximum detectable retention (99.99999%)

Table VII Retention of ^{131}I loaded as I_2 by Radshield 25 a)

| Bed depth (cm) | Residence time (s) | Retention (%) | | | |
|-------------------|-----------------------|-------------------------|---------------------|-----------------------|---------------------|
| | | 30 °C, 98 - 100 % R. H. | | 130 °C, 2 % R. H. | |
| | | 2 h ^{b), c)} | 168 h ^{b)} | 2 h ^{b), c)} | 168 h ^{b)} |
| 2.5 | 0.05 | 99.967 | 99.989 | 99.987 | 99.904 |
| 5.0 | 0.10 | 99.99979 | 99.9989 | 99.99997 | 99.9948 |
| 7.5 | 0.15 | 99.99991 | 99.99952 | - | 99.9984 |
| 10.0 | 0.20 | 99.99996 | 99.99976 | - | 99.9989 |
| 12.5 | 0.25 | 99.99998 | 99.99985 | - | 99.99920 |
| 15.0 | 0.30 | 99.99999 | 99.99990 | - | 99.99940 |
| 17.5 | 0.35 | - | 99.99993 | - | 99.99950 |
| 20.0 | 0.40 | - | 99.99995 | - | 99.99958 |
| 22.5 | 0.45 | - | 99.99996 | - | 99.99962 |
| 25.0 | 0.50 | - | 99.99997 | - | 99.99965 |

a) Values of additional parameters: see Table III

b) Purging time

c) - : Retention higher than maximum detectable retention (99.99999 %)

Table VIII Penetration of various activated carbons by ^{131}I loaded as I_2 ^{a)}

| Carbon | Bed depth (cm) | Residence time (s) | Penetration (%) | | | |
|--------------|-------------------|-----------------------|-------------------------|---------------------|-----------------------|---------------------|
| | | | 30 °C, 98 - 100 % R. H. | | 130 °C, 2 % R. H. | |
| | | | 2 h ^{b)} | 168 h ^{b)} | 2 h ^{b)} | 168 h ^{b)} |
| 207B (KI) | 5 | 0.1 | $6.5 \cdot 10^{-4}$ | $2.7 \cdot 10^{-3}$ | $1.5 \cdot 10^{-4}$ | $3.0 \cdot 10^{-3}$ |
| | 25 | 0.5 | $< 1.0 \cdot 10^{-5}$ | $1.2 \cdot 10^{-4}$ | $< 1.0 \cdot 10^{-5}$ | $1.9 \cdot 10^{-4}$ |
| 207B (TEDA) | 5 | 0.1 | $5.2 \cdot 10^{-4}$ | $1.5 \cdot 10^{-3}$ | $1.8 \cdot 10^{-3}$ | $3.8 \cdot 10^{-1}$ |
| | 25 | 0.5 | $3.8 \cdot 10^{-5}$ | $1.2 \cdot 10^{-4}$ | $1.2 \cdot 10^{-4}$ | $3.7 \cdot 10^{-3}$ |
| Kiteg II | 5 | 0.1 | $2.3 \cdot 10^{-4}$ | $2.4 \cdot 10^{-3}$ | $7.3 \cdot 10^{-5}$ | $4.3 \cdot 10^{-2}$ |
| | 25 | 0.5 | $< 1.0 \cdot 10^{-5}$ | $1.9 \cdot 10^{-4}$ | $< 1.0 \cdot 10^{-5}$ | $4.4 \cdot 10^{-4}$ |
| Radshield 25 | 5 | 0.1 | $2.1 \cdot 10^{-4}$ | $1.1 \cdot 10^{-3}$ | $3.0 \cdot 10^{-5}$ | $5.2 \cdot 10^{-3}$ |
| | 25 | 0.5 | $< 1.0 \cdot 10^{-5}$ | $3.0 \cdot 10^{-5}$ | $< 1.0 \cdot 10^{-5}$ | $3.5 \cdot 10^{-4}$ |

a) Values of additional parameters: see Table III

b) Purging time

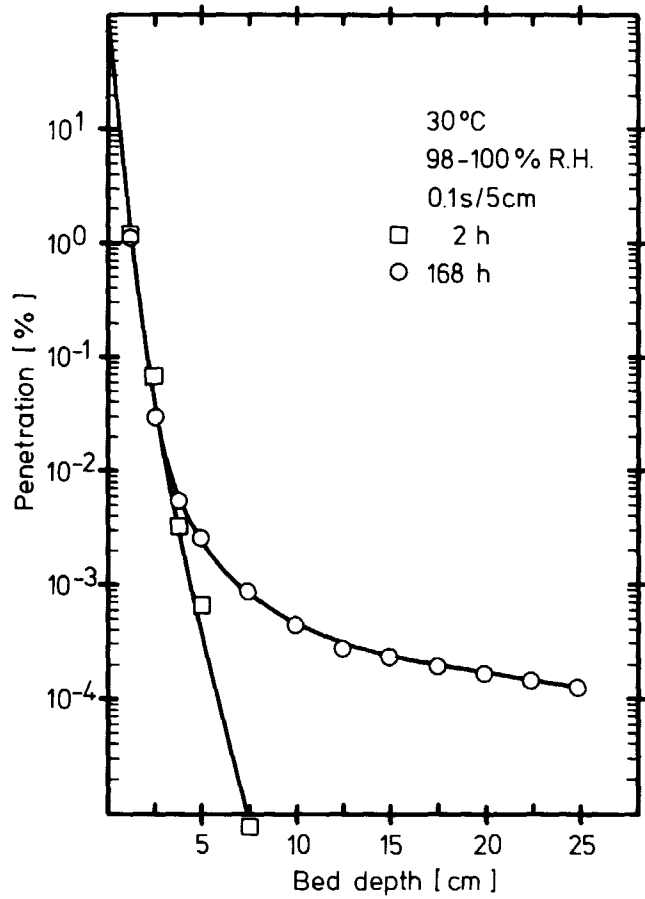

Penetration of 207B(KI) by ^{131}I loaded as I_2 ,
at different purging times

Fig. 1 a)

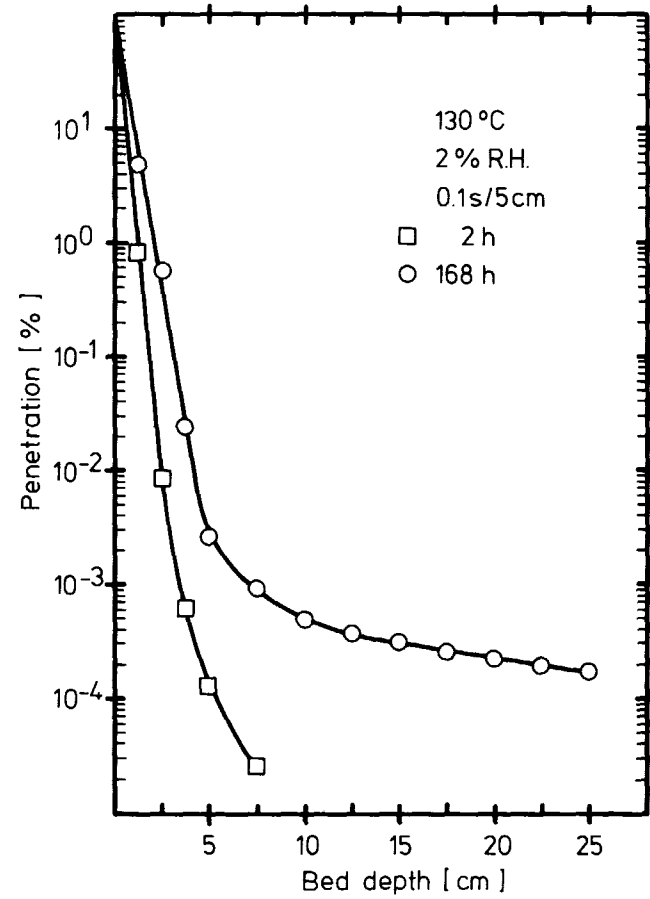

Penetration of 207B(KI) by ^{131}I loaded as I_2 ,
at different purging times

Fig. 2 a)

- a) The values of the test parameters are indicated in Table III.
The corresponding retention is given in the respective tables.

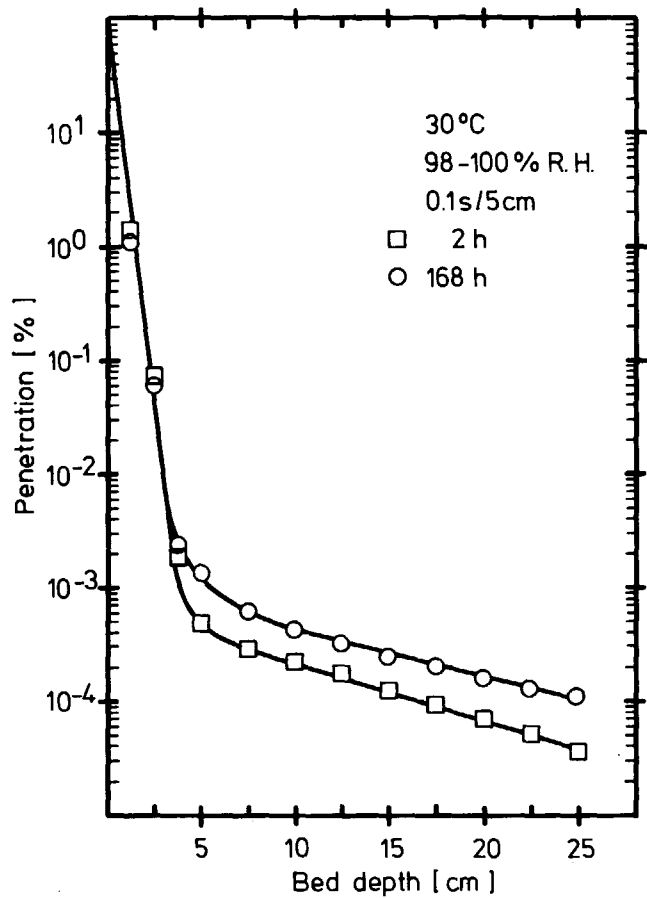

Penetration of 207B (TEDA) by ¹³¹I loaded as I₂,
at different purging times

Fig. 3

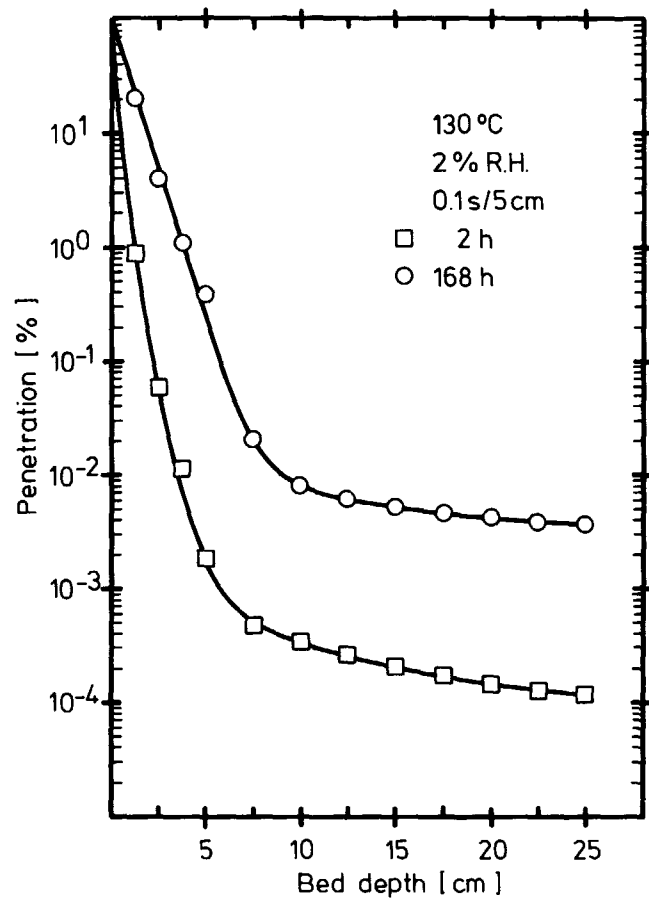

Penetration of 207B (TEDA) by ¹³¹I loaded as I₂,
at different purging times

Fig. 4

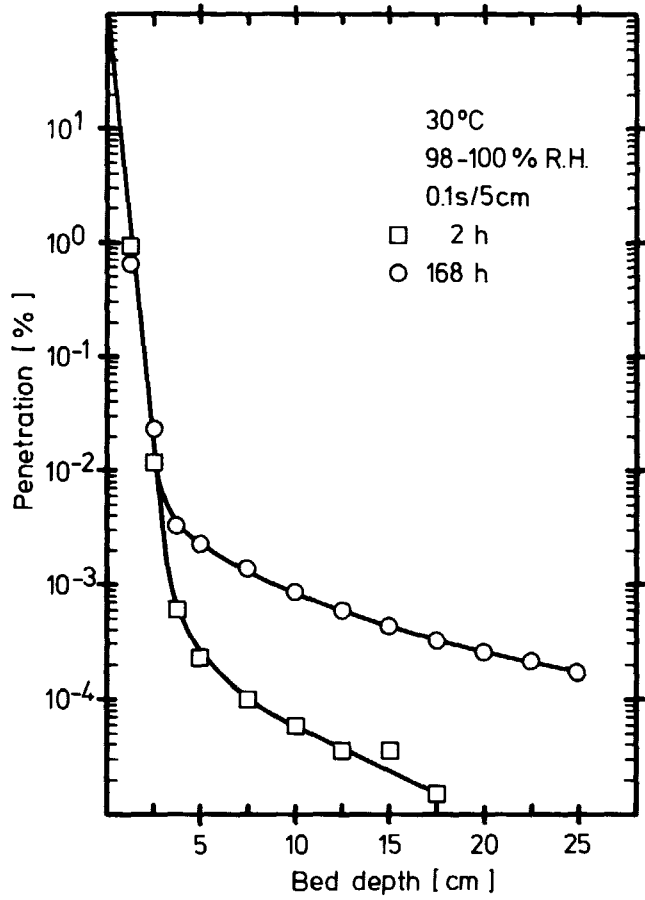

Penetration of Kiteg II by ^{131}I loaded as I_2 , at different purging times

Fig. 5

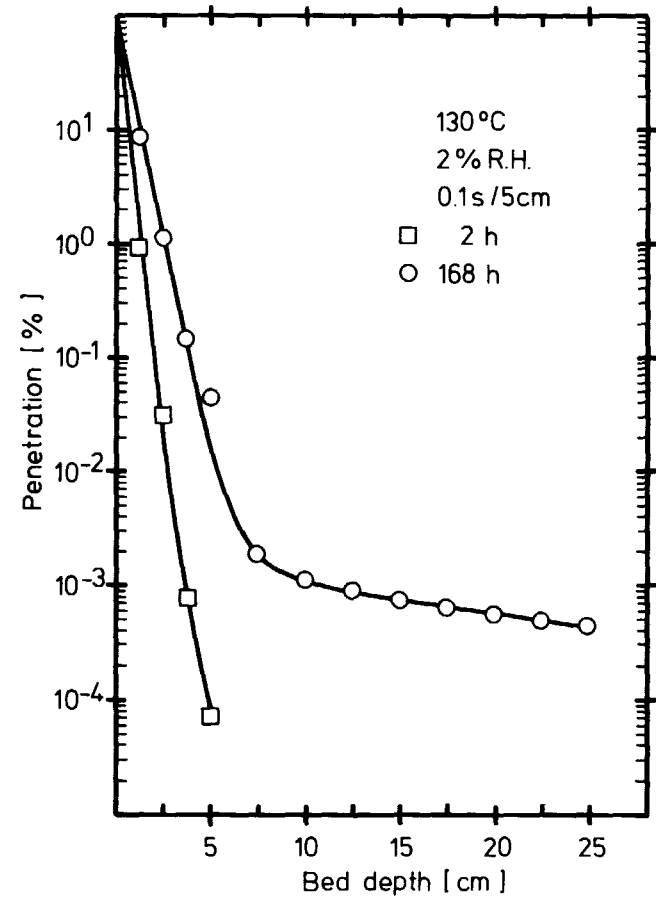

Penetration of Kiteg II by ^{131}I loaded as I_2 , at different purging times

Fig. 6

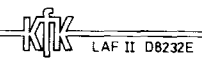

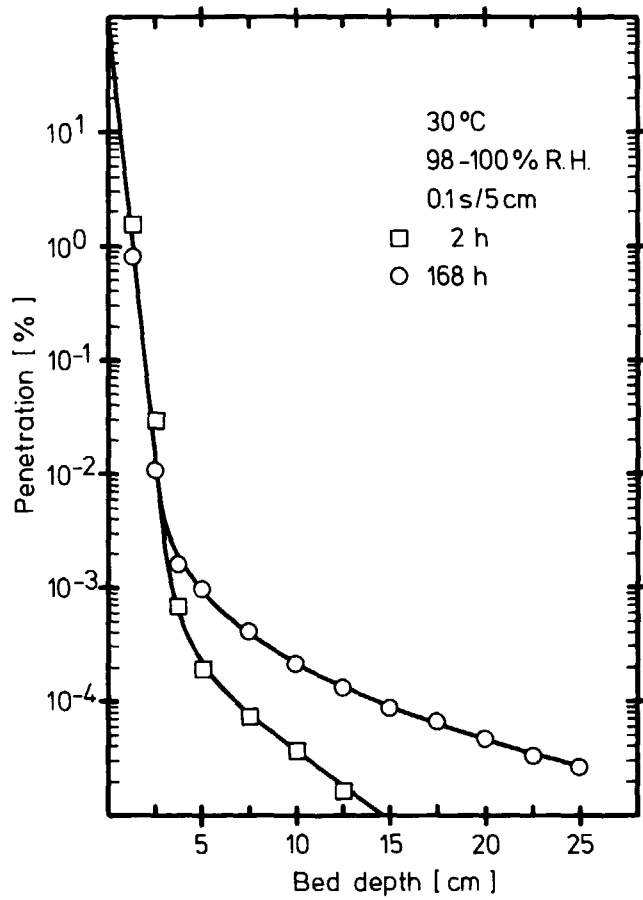

Penetration of Radshield 25 by ^{131}I loaded as I_2 ,
at different purging times

Fig. 7

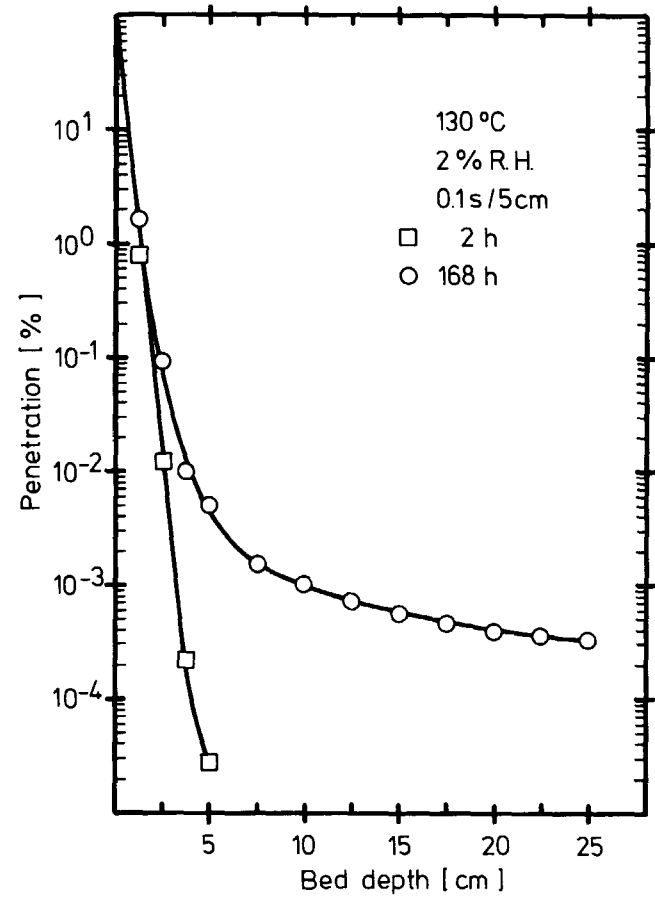

Penetration of Radshield 25 by ^{131}I loaded as I_2 ,
at different purging times

Fig. 8

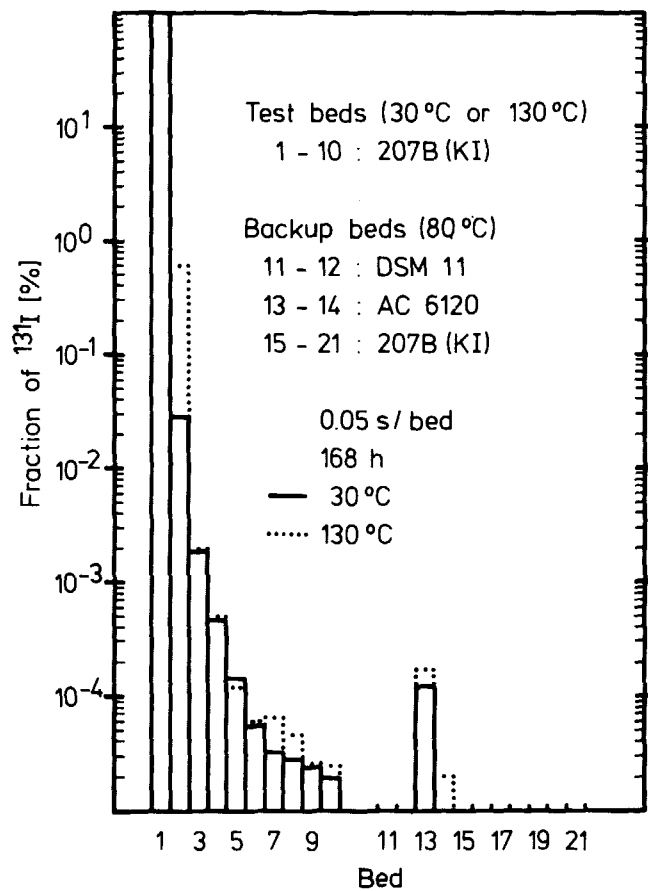

Distribution of ^{131}I among test and backup beds
(^{131}I loaded as I_2)

Fig. 9

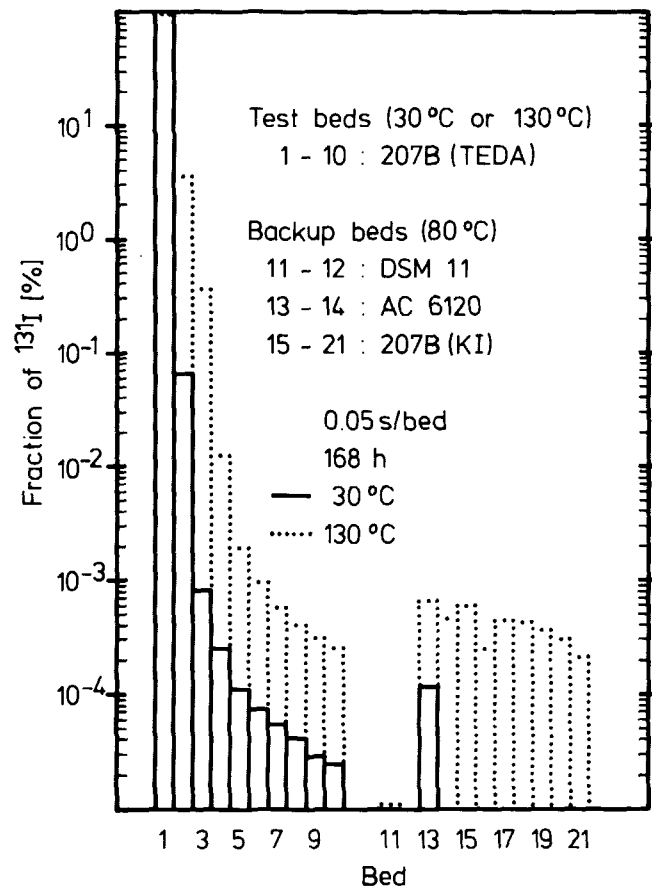

Distribution of ^{131}I among test and backup beds
(^{131}I loaded as I_2)

Fig. 10

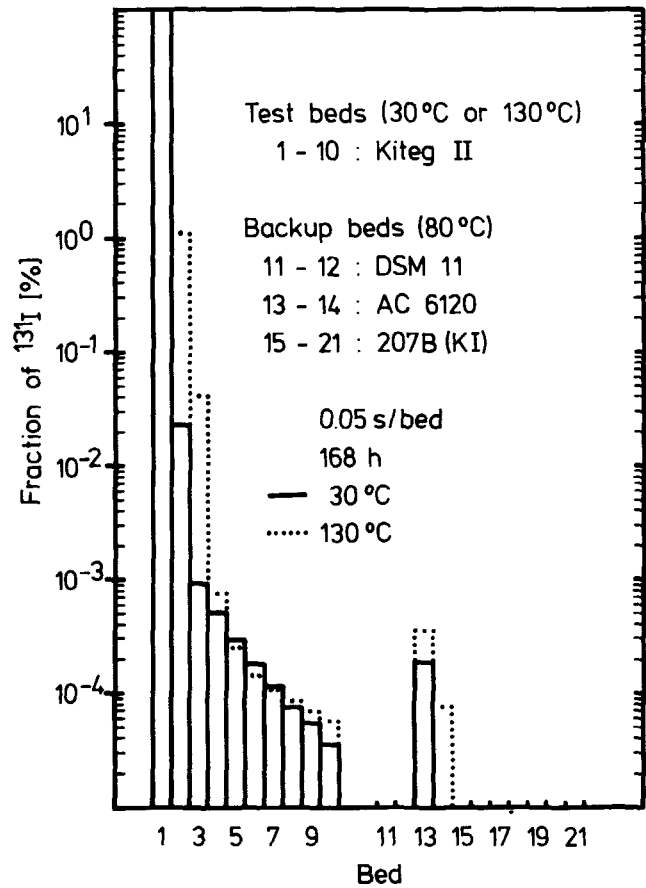

Distribution of ^{131}I among test and backup beds
(^{131}I loaded as I_2)

Fig. 11

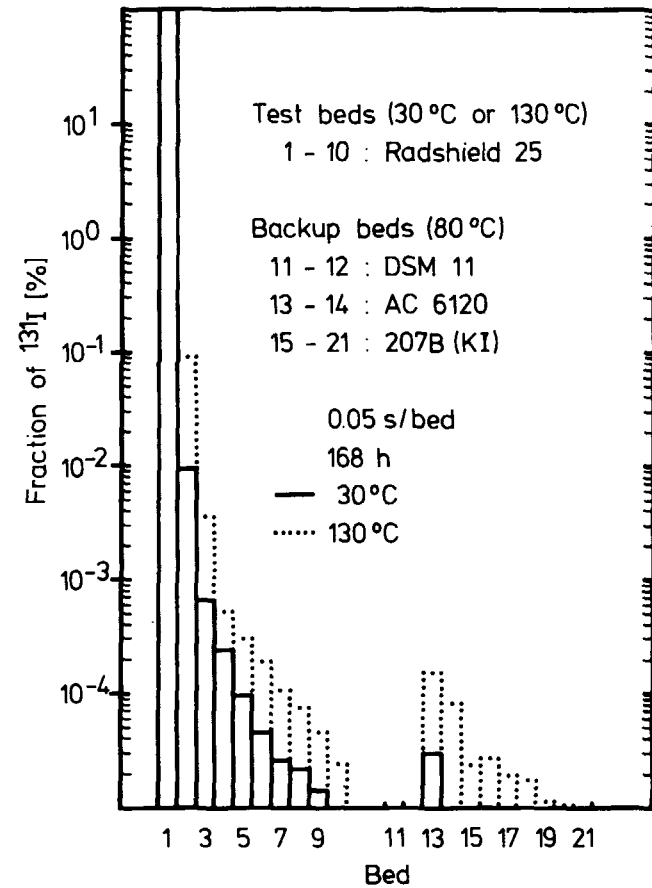

Distribution of ^{131}I among test and backup beds
(^{131}I loaded as I_2)

Fig. 12

DISCUSSION

DEITZ: Do your results apply to weathered carbons?

DEUBER: The results of this paper apply to new carbons only. The effect of aging is being investigated.

WILHELM: Regarding the question of Dr. Deitz, I would like to add that the desorption experiments will be continued on carbon samples aged in reactor stations. The results are not yet available. We may get the results of the weathered carbons in time for the next Air Cleaning Conference. You have to keep in mind that the real bed is double that shown here. If we used the real bed depth for these studies it would not be possible to detect activity on the downstream side as the decrease would be six orders of magnitude or more. With the real filter we are sure we meet the German standard.

DEUBER: I would like to add that what is coming out of the adsorber is not elemental iodine. This, of course, increases the safety margin.

BURCHSTED: The tests reported were all impregnated carbons. Did you make comparative tests with unimpregnated carbons, and if so, what were the results for elemental iodine?

DEUBER: We made some tests with unimpregnated carbons at 30°C. As regards penetration of I₂ (steep part of the penetration curve), no significant difference was found compared with impregnated carbons.

BANGART: Why was it necessary to increase the removal efficiency guidelines and are you required to meet the same guidelines regardless of differences in facility design or siting factors, such as differences in the distance to the nearest offsite residents?

DEUBER: The minimum I₂ retention to be achieved with accident filters of PWRs was raised in the new guidelines because otherwise unacceptably high doses would be calculated. The dose calculation requirements have been changed. The new guidelines apply to all new PWRs.

17th DOE NUCLEAR AIR CLEANING CONFERENCE

EXPERIENCES WITH A CHARCOAL GUARD BED IN A NUCLEAR POWER PLANT

L.C. Scholten
Environmental Research Department
N.V. KEMA
Joint laboratories of the electric utilities in The Netherlands
Arnhem, The Netherlands

Abstract

Deterioration of the charcoal in an iodine filter is a well-known problem. At a Dutch nuclear power plant the life-time of the charcoal was less than 3 months, at continuous service. A simple guard bed filled with unimpregnated charcoal was placed in front of the main bed. Now the life-time is several years. Results are shown of laboratory tests on charcoal from test canisters.

I. Introduction

The quality of impregnated charcoal in iodine filters at nuclear power plants decreases during service. (1) The static and dynamic ageing can be more or less predicted, but poisoning causes more often a much faster decrease. This problem has been distinguished for a long time (2). Several countermeasures are suggested. M.W. First has pleaded for guard beds in which organic vapours are prefiltered (3). A concept for prefiltering is given by Ohlmeyer (4) which uses the old charcoal from the main bed as prefilter material in a multi-way sorption bed. Wilhelm has pleaded for organizational measures and the use of overdimensioned filters (5).

Soon after the start-up of a Dutch nuclear power plant a severe deterioration of the charcoal in an iodine filter was detected and the charcoal had to be rejected immediately. The cause of the deterioration was a poisoning by aromatics as was predicted by Wilhelm (6). The problem had to be solved at short notice and a simple guard bed was constructed. The bed proved to be a good solution for this particular plant. The construction of the bed and experimental results are given below.

II. Description of the system

The reactor involved is of standard German design with a nominal power of 450 MWe. It is situated at an estuary and in the vicinity are an oil refinery and an aluminium foundry, so poisoning of the charcoal by air-pollutants from outside the plant is not unlikely. The containment consists of a spherical inner containment and a cylindrical outer containment. The inner containment is divided in two parts. The upper part has service rooms and is normally accessible. In the

lower part the primary loops are situated with all the greater components as reactor vessel, steam generators and so on. The air in the equipment room is internally recirculated, partly over an absolute-charcoal-absolute filter installation. The equipment room is kept at underpressure in respect of the service room by sucking off over a deep-bed charcoal filter direct to the stack. A simplified ventilation scheme of the plant is given in Figure 1. The secondary containment is normally ventilated over absolute filters and will only be sucked over a charcoal filter after an accident.

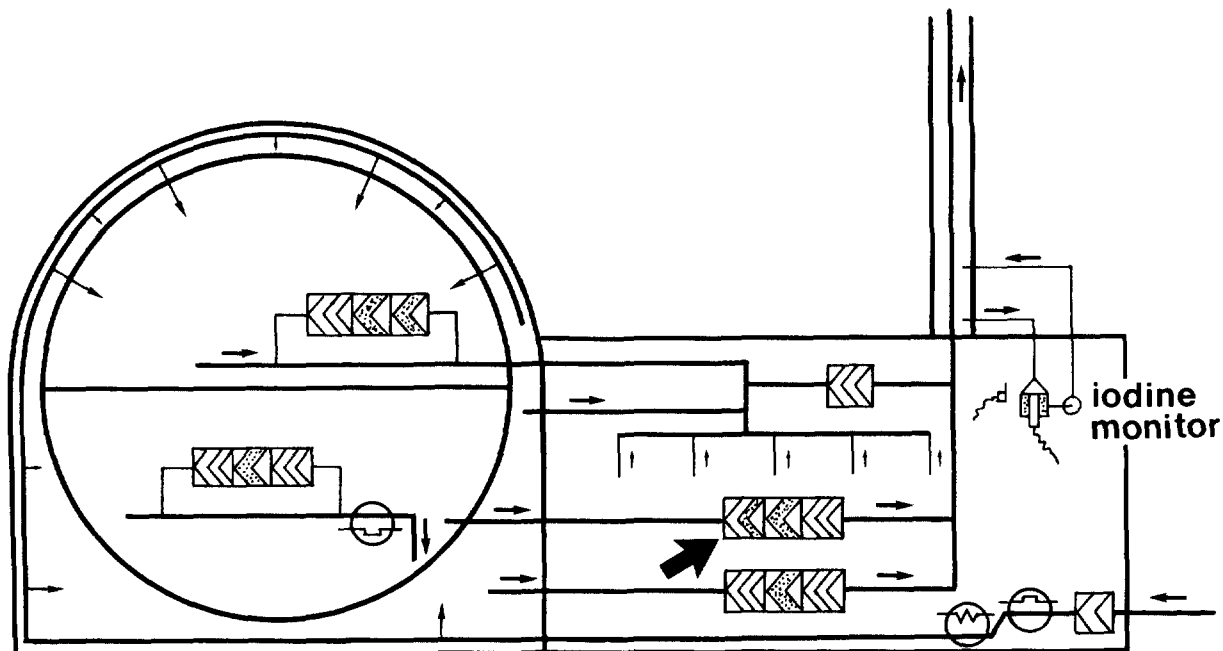

Figure 1 Simplified ventilation scheme of a PWR

The filter installation for the suck-off of the equipment room originally contained two 100% redundant absolute-charcoal-absolute filters. Therefore, only one of the filters is in continuous service. In the licensing of the plant it is stated that these filters should have an efficiency for methyl iodide of at least 99%, at a relative humidity of near 100% at 30°C. The charcoal filter consists of a vessel filter with a bed-depth of 50 cm and a nominal staytime of 1 second. In front of and behind the charcoal bed a HEPA filter is provided with the standard dimensions of 610 x 610 x 292 mm. Parallel to the main bed are two control filters with the same bed-depth.

17th DOE NUCLEAR AIR CLEANING CONFERENCE

By regulatory demand the quality of the charcoal from the control filters must be tested yearly at the laboratory, and in-situ tests must be executed every 2 years and after each refill. The same figures are applicable for the emergency filter of the secondary containment exhaust. So far the service-time of this filter has only been for trial.

III. Performance of the charcoal

The charcoal for the first initial filling of the beds was previously tested with CH_3I and showed a K-factor of $4,5 \text{ s}^{-1}$ at the specified conditions. The required K-factor is $\geq 2 \text{ s}^{-1}$. Also the in-situ test was satisfactory. After a year, in which the reactor was started up, the charcoal from the control filters was submitted to the first periodical test. The test was done at our laboratory installation, as described earlier (7). The test conditions are given in Table I. The charcoal was rejected. The beds were refilled with charcoal from stock and tested in-situ. After half a year the charcoal from the control filters was tested for security. Again the charcoal was rejected. This batch had a content of aromatics of 14 mg.g^{-1} . From interpolation the life-time was estimated at 4 to 5 months.

Table I Test conditions

| | | |
|----------------------|-----------------------|----------------------|
| Challenge gas | CH_3I | |
| Loading | 20 ³ | $\mu\text{g.g}^{-1}$ |
| Bed diameter | 25 | mm |
| Bed length | 50 | cm |
| Superficial velocity | 50 | cm.s^{-1} |
| Staytime | 1.0 | s |
| Relative humidity | ≥ 99 | % |
| Temperature | 30 | $^{\circ}\text{C}$ |
| Preconditioning time | 16 | h |
| Sweep time | 1 | h |
| Post sweep time | 2x2 | h |

A quick solution was desired. Therefore, a simple guard bed was constructed (Figure 2). The content is 50 dm^3 , which is about 10% of the main bed. It is filled with pure, unimpregnated charcoal of $\phi 4 \text{ mm}$ bars. A simple prefilter mat is placed in front of the bed. The casing dimensions are equal to a standard HEPA filter of $1800 \text{ m}^3.\text{h}^{-1}$. So it could be placed in front of the main bed instead of the projected HEPA filter.

No reconstructions of the filter housing were necessary. No time was available to measure the type and quantity of the air-pollution, neither their influence on charcoal. So the performance could not be calculated exactly. From the content of organic solvents on the rejected charcoal from

the main bed, and some general adsorption figures of aromatics on pure charcoal, a life-time for the guard bed was estimated of at least 3 months. A procedure was set up whereby every 3 months the charcoal in the guard bed was replaced. Thereby no retesting or a costly in-situ test is required.

Figure 3 shows the performance of the main bed after the installation of the guard bed. In the beginning the charcoal was tested every 3 months, but later on the frequency was decreased to once every year. As can be seen from the figure, a life-time of many years may be expected, any how much better than those few months without the guard bed.

IV. Discussion

The deterioration of the charcoal in the main bed was due to organic vapours. For this particular plant a simple guard bed placed in front is already adequate to protect the main bed against vapours. The low-volatile organic components in the air are captured in the guard bed. The high-volatile components will pass the guard bed, but consequently also the main bed. In our laboratory tests we use a preconditioning time of 16 hours. So we do not measure the influence of the high-volatiles. But for those components which are blown away during preconditioning, the material balance on the charcoal will be low in actual practice. So their effect on the quality of the charcoal will also be low.

We had to make the design of the guard bed in a hurry. The results, however, are very satisfactory. The cost of one filling is about \$ 50. The pressure drop is 10-15 mm WG. We believe that this simple design can be used satisfactorily at more plants, at low operational costs, especially because the frequency of costly tests can be reduced. Due to its standard dimensions it can often be installed without additional costs for rebuilding.

V. References

- 1 Collins, R.D. et al., "The ageing of charcoal used to trap radioiodine"; Proc. IAEA-symp. on the Management of gaseous Wastes from Nuclear Facilities. Paper no. SM-245/17 Vienna (18-22 February 1980).
- 2 Ackley, R.D. and Adams, R.E., "Ageing and weathering of impregnated charcoals used for trapping radioiodine (an interim report)"; Proc. Tenth AEC Air Cleaning Conference, NTIS, Springfield, VA (p. 170) (1968).
- 3 First, M.W., "Trends in the design and operation of off-gas cleaning systems in nuclear facilities"; Proc. IAEA-symp. on the Management of gaseous Wastes from Nuclear Facilities. Paper no. SM-245/62 Vienna (18-22 February 1980).

17th DOE NUCLEAR AIR CLEANING CONFERENCE

- 4 Ohlmeyer, M. and Benzel, M., "Higher safety and saving of filter material with multi-way sorption filters"; Kerntechnik 20 no. 2 p. 86-93 (1978).
- 5 Wilhelm, J.G., "Iodine filters in nuclear power plants"; CEC-document V/1531/76-E, Luxembourg (1976).
- 6 Wilhelm, J.G. and Gerlach, K., "Ergebnisse und Erfahrungen aus der Untersuchung von Jodfiltern"; Proc. Seminar on Iodine filter testing, Karlsruhe, 4-6 Dezember 1973; CEC-document V/559/74, Luxembourg (1974).
- 7 Lugt, van der G. and Scholten, L.C., "Methods used at KEMA for measuring iodine adsorption on charcoal and experiences with charcoal filters installed at a nuclear power plant"; Proc. Seminar on Iodine filter testing, Karlsruhe, 4-6 Dezember 1973; CEC-document V/559/74, Luxembourg (1974).
- 8 Scholten, L.C. and Landman, E.B., "In-situ testing of charcoal filters in the Dutch nuclear power plants"; Proc. Seminar on Iodine removal from gaseous effluents in the nuclear industry, Mol, 21-24 September 1981; CEC-document V/5283/82, Luxembourg (1982).

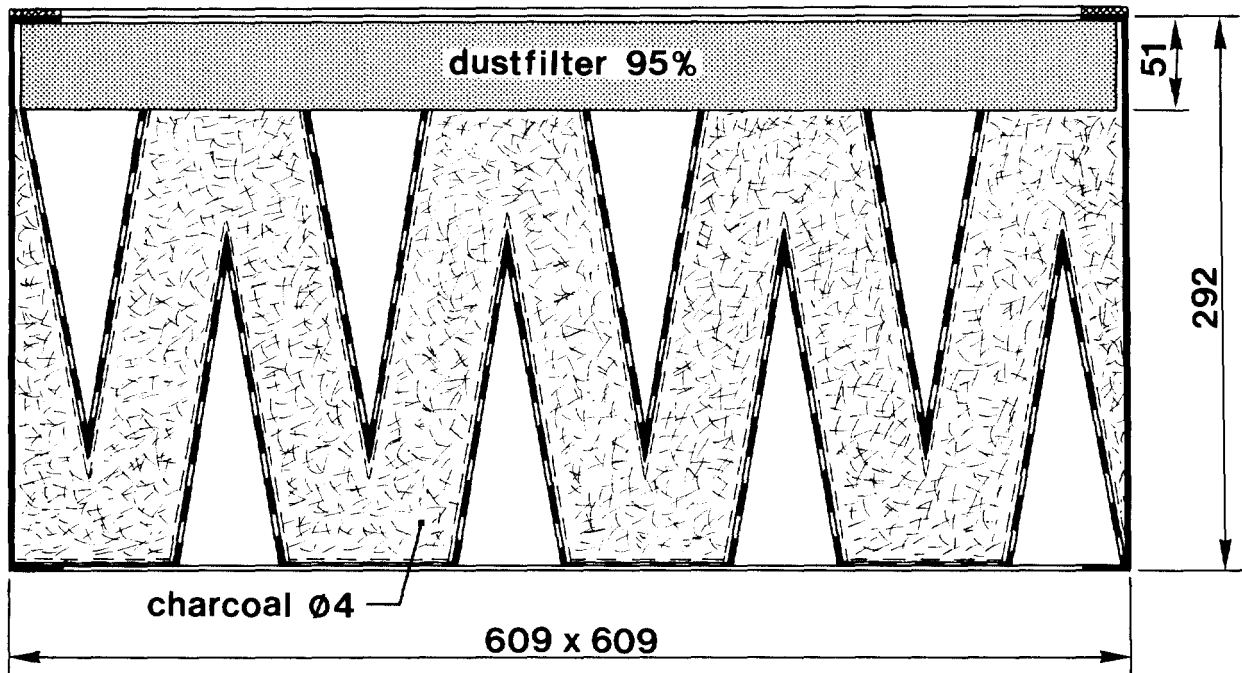

Figure 2 Charcoal guard bed

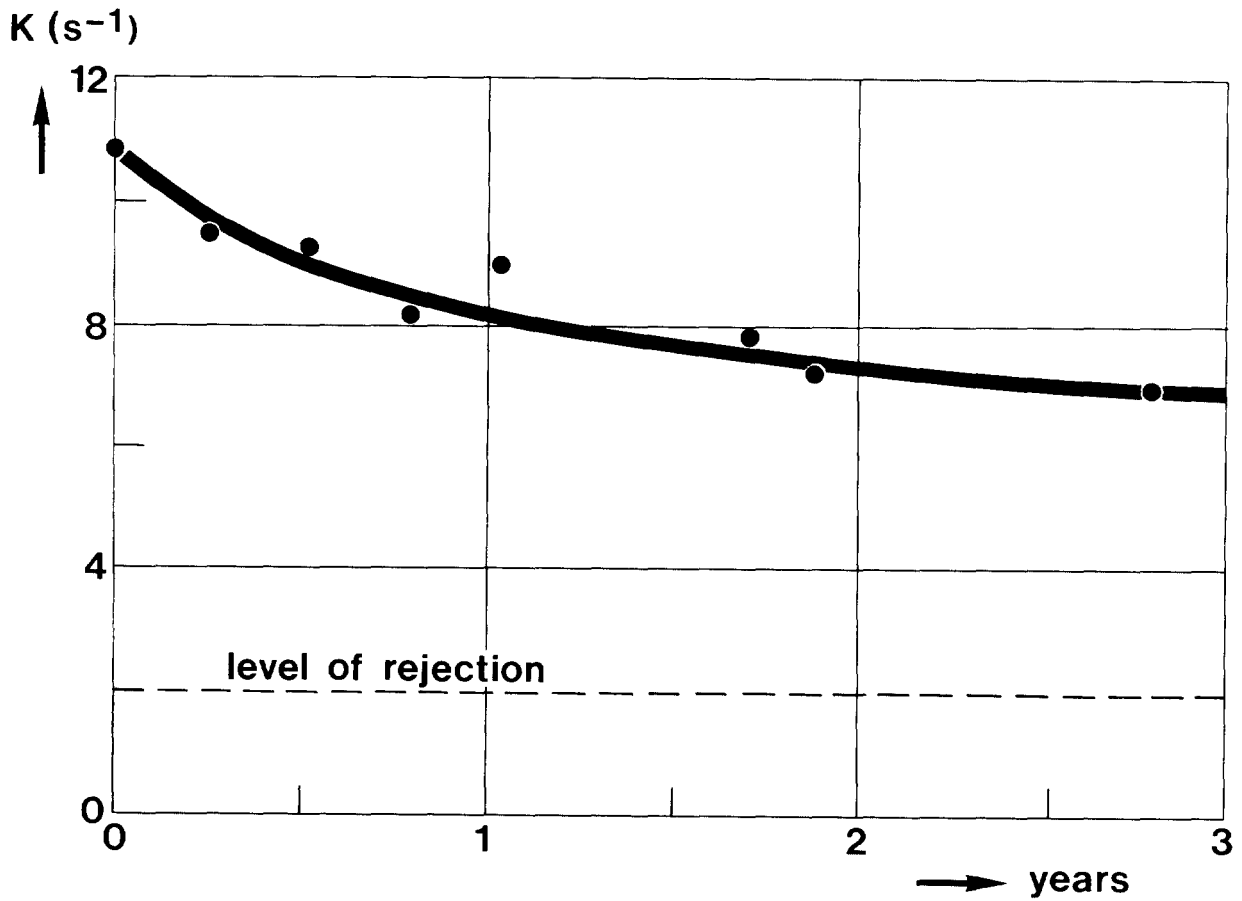

Figure 3 Decrease of charcoal quality with use of a guard bed

DISCUSSION

DEUBER: Do the K values shown in Figure 3 apply to carbon samples from by-pass cartridges?

SCHOLTEN: Yes, the figures are from samples tested in our laboratory installation.

BELLAMY: Please define your term, "K-factor".

SCHOLTEN: It is the logarithm of the decontamination factor divided by the stay-time. It is a very useful figure to compare the removal efficiencies of different batches of carbon.

DEPOSITION OF AIRBORNE RADIOIODINE SPECIES
ON SURFACES OF METALS AND PLASTICS

M.J. Kabat
Ontario Hydro
Health and Safety Division
P.O. Box 160
Pickering, Ontario
Canada

Abstract

In this study the deposition velocity of gaseous radioiodine species I_2 , HOI and CH_3I on several materials, which are commonly used in nuclear industry, was experimentally evaluated. Materials were identified which cause minimal deposition loss of airborne radioiodine sample in remote sampling systems. It was found that carbon steel and stainless steel, both extensively used in the construction of sampling lines, have high affinity for elemental iodine vapour. This causes significant loss of iodine sample due to wall deposition, particularly at high humidities which prevail under emergency release conditions. Aluminum, polyethylene and teflon cause minimal loss of iodine sample in remote sampling applications under both normal and emergency release conditions in nuclear power plants.

I. Introduction

It has been generally recognized that high chemical affinity of iodine can lead to significant sampling errors due to its wall deposition in sampling lines. For this reason it has been recommended in the ANSI N 13.1 standard (1) that "Materials to be avoided for sampling iodine are rubber, copper and some plastics". However, while all essential requirements for airborne particles sampling were clearly specified, no actual values and limits on iodine sample loss, due to deposition, were found in this standard and other available literature.

Practical experience from our experimental investigation on the behaviour of gaseous iodine species indicated that significant deposition of airborne inorganic iodine species occurs also on other metals and plastics, commonly used in the construction of lines for remote sampling of airborne radioiodine from operational areas and gaseous effluents of nuclear facilities. To correctly define and minimize experimental errors involved in gaseous radioiodine monitoring, an experimental study was performed on the deposition of its airborne species on sampling line internal surfaces under most common sampling conditions. The experimental setup and procedures are further described and results discussed.

II. General Requirements on Remote Sampling of Iodine

Accuracy requirements for gaseous effluent monitoring have not been officially established. A simplified assumption was made in this experimental study that the overall error, which is the total of sampling and detection, experimental and statistical errors, should not exceed $\pm 40\%$. Then, if the detection system performs with an accuracy as high as $\pm 15\%$ and the air sample in the sampling nozzle is perfectly representative, only $\pm 25\%$ is allowed for sample loss error due to the combination of:

1. Iodine deposition in sampling line.
2. Gaseous iodine absorption in particulate sample collector.
3. Iodine penetration through the iodine sample collector.
4. Air sample bypassing the collector.
5. Ambient air in-leak into the collection system.

The above factors are variable and can reach significant values under typical operating conditions. All of them cause negative errors, some of which can result in unacceptable underestimates of iodine levels in monitored areas or gaseous effluents.

Iodine loss in particulate collectors can be minimized with the use of suitable (pure glass fibre) filter which does not chemically react with elemental iodine vapour and hypoiodous acid.

The identification of sample loss, from the above factors 3, 4 and 5, was described in publication (2). The experimental determination of iodine sample loss due to wall deposition is further described.

III. Theoretical Aspects of Iodine Deposition

For field applications it is not possible to accurately define, or control operational conditions and state of materials which are associated with iodine deposition on internal surface of sampling lines. Therefore, only essential theoretical aspects of iodine deposition were evaluated, which were relevant to this experimental project.

The rate of gaseous iodine species deposition on surfaces is comprised of two components:

- the rate of iodine molecule diffusion through a carrier gas to surfaces
- the rate of chemical reaction of the surface materials with molecules of iodine species

17th DOE NUCLEAR AIR CLEANING CONFERENCE

From experimental data in publication (3) it is evident that suppression effect of the diffusion process can be neglected when surfaces are exposed to rapidly exchanging, turbulent challenge gas in small diameter sampling tubes. Therefore, chemisorption controls the rate of iodine deposition.

Furthermore, it can be assumed, even for emergency release conditions, that the airborne concentration of airborne species in sample stream is very low (< 10 µg/l). Therefore, surface saturation with iodine reaction products does not occur through reasonably long sampling periods.

Under the above conditions, the rate of iodine deposition dI/dt is proportional to the deposition velocity constant V_g , the exposed surface area A (m^2) and airborne iodine concentration I_C ($Bq \cdot m^{-3}$)

$$\frac{dI}{dt} = V_g \times A \times I_C \quad (Bq \cdot s^{-1})$$

V_g is proportional to the reaction rate of iodine with a specific element or chemical compound under defined reaction conditions:

$$V_g = \frac{I_s}{I_C \times t} \quad (m \cdot s^{-1})$$

I_s = iodine deposited per unit of exposed surface ($Bq \cdot m^{-2}$)

t = exposure period (s)

Then the deposition of iodine D_u per unit length of the sampling line is:

$$D_u = \frac{V_g \times A_u \times R_u}{V_u} \quad (m^{-1})$$

A_u = internal surface area per unit of length

R_u = residence time per unit of length

V_u = internal volume per unit of length

and the fraction of iodine, D_L , deposited from air sample at any length L of the sampling line, is:

$$D_L = 1 - e^{-D_u \times L}$$

Since the iodine deposition mechanism is based on its chemisorption, it can be assumed that impurities, oxidation products and air humidity have significant influence on the deposition rates. The value of V_g is also affected by mass transfer conditions. For example slow transfer is provided by pure diffusion in large volumes of steady air, while more rapid mass transfer occurs in laminar flow or turbulent flow conditions in small diameter sampling lines.

IV. Materials Tested

The iodine deposition velocity values were evaluated with copper, carbon steel, stainless steel, aluminum, polyvinylchloride, polyethylene and teflon. Test strips of the above materials were cut out of sheets 0.5 - 1 mm thick and tested "as received" with an original surface, established during long-term storage in clean atmosphere.

Since various solvents or solutions are used in some facilities to decontaminate or remove corrosion products from sampling lines, iodine deposition on clean metal surfaces was also evaluated. For this purpose the tested metals were initially rinsed in methanol. Then copper, carbon and stainless steel were etched in 1% HCL solution, and aluminum in 1% NaOH. The metals were then washed in distilled water and rinsed with methanol.

V. Experimental System

Method Description

The deposition velocity of elemental iodine vapour and gaseous HOI and CH_3I , on surfaces of above listed materials, was evaluated under both laminar and turbulent flow conditions. Well defined samples of tested material were exposed to continuously passing air, containing single, almost pure, chemical species of iodine. Sufficiently high air flow was applied to minimize the effect of iodine depletion from challenge gas, passing the exposure chamber. A species selective iodine samplers collected iodine, downstream of the tested material. The airborne concentration of the iodine species was determined from iodine activity, measured in each section of the sampler and total volume of air that was passed through the chamber during the test period. Radioiodine deposited on the tested material was also measured and V_g calculated from the equation given in paragraph 2.

17th DOE NUCLEAR AIR CLEANING CONFERENCE

Selective samplers containing Cu screens, HOI absorbent and TEDA charcoal, described in publication (4), were applied for the analysis of gaseous iodine species.

Testing Parameters

The deposition experiments were performed under the following conditions:

Physical Conditions:

| | |
|-------------------|--|
| Temperature Range | 20 to 24°C |
| Relative Humidity | 5 and 97 ± 3% RH |
| Challenge Gas | laboratory air, containing specific iodine forms |
| Pressure | atmospheric |
| Concentrations | I ₂ ; 10 µg/l ± 30% |
| | HOI; 0.01 - 0.05 µg/l |
| | CH ₃ I; 1 µg/l ± 20% |
| Flow | 0.1 lpm through each test line |

Tested Materials:

- Copper, carbon steel, stainless steel and aluminum (tested with both original and chemically cleaned surfaces).
- Polyvinylchloride, polyethylene, teflon, rubber (tested only with original surfaces).

Surface Areas:

- single strips, 560 mm² each, in type 1 exposure chambers
- eight plates, 1600 mm² each, in type 2 exposure chamber

Equipment and Procedure

The experimental setup, used for the evaluation of iodine deposition under laminar flow conditions is illustrated in Figures 1 and 2.

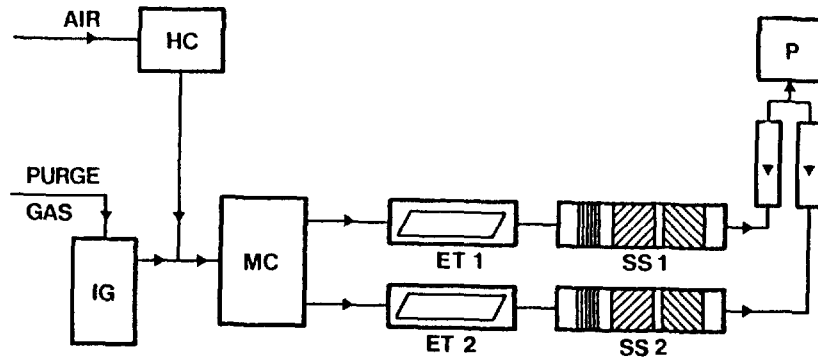

Figure 1
Diagram of iodine deposition test system

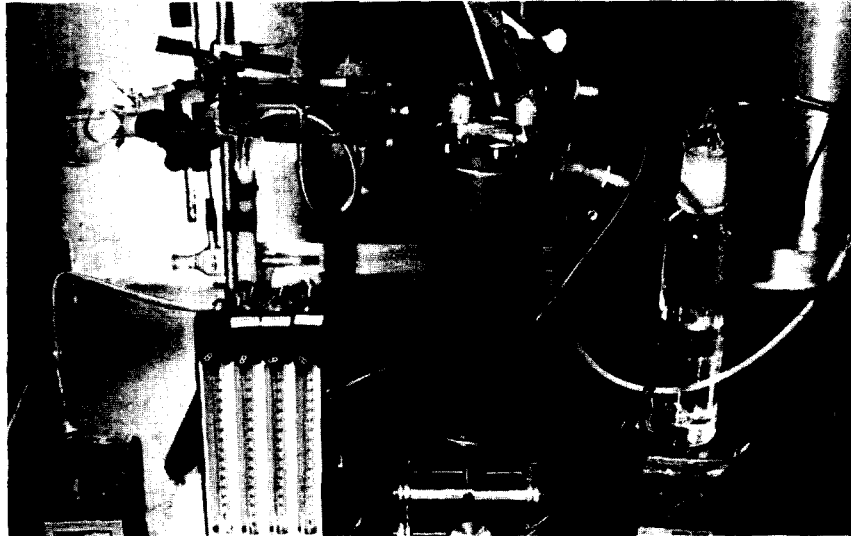

Figure 2
Experimental setup, used for the evaluation of iodine species deposition

Individual chemical forms of gaseous radioiodine (I_2 , HOI and CH_3I), formed in the generator IG, were mixed with air conditioned to the required humidity level in HC, and carried into the mixing chamber MC. Two samples of tested material were installed in glass exposure tubes ET and simultaneously exposed to passing challenge gas. Subsequently, iodine species were collected with selective samplers SS. Two samples of each tested metal, "as received" and "chemically cleaned", were simultaneously exposed to identical challenge gas to evaluate the effect of surface protection, impurities and corrosion products on their surface.

The exposure tubes, illustrated as a part of experimental setup in Figures 1 and 2, contain single strips (40 x 7 mm) of tested material in glass tubes (9 mm ID) to present laminar flow conditions in a sampling line. The "type 2" exposure chamber, illustrated in Figure 3, containing up to eight samples (40 x 40 mm each) was used to evaluate the difference between laminar and turbulent flow conditions. The first set of plates was exposed to laminar flow in the chamber while the second set was installed across the flow direction, to develop turbulent conditions. Only a single exposure chamber of the second type was tested at a time.

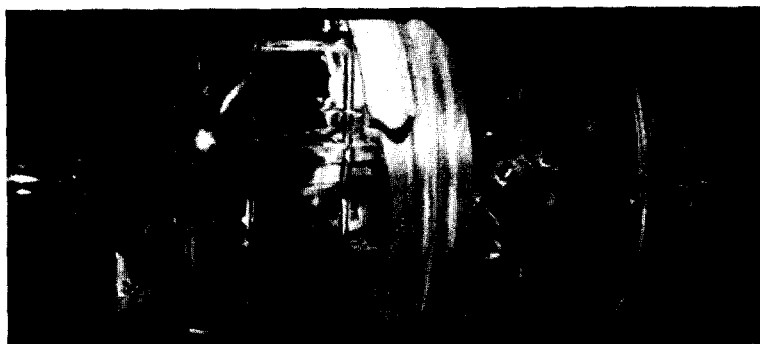

Figure 3

"Type 2" chamber, containing eight samples, used for the testing of iodine deposition in laminar and turbulent flow.

Elemental iodine vapour was generated from chilled, $5 \times 10^{-5}M$ solution of elemental iodine in distilled water, hypoiodous acid was purged from $5 \times 10^{-8}M$ solution of elemental iodine in distilled water and methyl iodide released from a pressure cylinder.

VI. Discussion of ResultsIodine Deposition on Metal Surfaces

The experimentally determined values of the deposition velocity, V_g , are listed in Table 1. Each value of V_g was confirmed by at least two measurements.

Table I

Measured velocity values of iodine species deposition on metal surfaces

| Exposure Conditions | | | Deposition Velocity V_g . ($m \cdot s^{-1}$) | | | |
|---------------------|---------------------------|---------|--|--------------|---------------|----------|
| Iodine Form | Relative Humidity % (#3#) | Surface | Copper | Carbon Steel | Stainl. Steel | Aluminum |
| I_2 | 5 | N.Cl. | 2.0(-3) | 3.4(-4) | 1.8(-4) | 8.4(-5) |
| | | Ch.Cl. | 2.3(-3) | 1.1(-3) | 8.7(-4) | 1.7(-4) |
| | 97 | N.Cl. | 2.1(-3) | 1.3(-3) | 1.6(-3) | 8.0(-4) |
| | | Ch.Cl. | 2.3(-3) | 2.5(-3) | 2.0(-3) | 1.8(-3) |
| HOI | 5 | N.Cl. | 1.0(-5) | 1.4(-5) | 4.0(-6) | 1.9(-6) |
| | | Ch.Cl. | 1.4(-4) | 8.0(-6) | 3.3(-5) | 2.5(-5) |
| | 97 | N.Cl. | 2.2(-4) | 2.0(-5) | 1.8(-5) | 1.2(-5) |
| | | Ch.Cl. | 2.7(-4) | 3.8(-5) | 4.4(-5) | 5.6(-5) |
| CH_3I | 5 | N.Cl. | 2(-8) | 8(-8) | 1(-7) | 8(-8) |
| | | Ch.Cl. | 1(-7) | 8(-8) | 7(-8) | 1(-7) |
| | 97 | N.Cl. | 7(-8) | 4(-8) | 8(-8) | 4(-8) |
| | | Ch.Cl. | 7(-8) | 4(-8) | 8(-8) | 1(-6) |

V_g = deposition velocity (exp)

N.Cl. = non-cleaned surface

Ch Cl = chemically cleaned surface

For easier comparison of iodine loss, D_L values in 30 m length of 12.5 mm ID sampling line, at 100 lpm sampling flow, were calculated for all tested materials. The D_L values for tested metals are listed in Table II.

17th DOE NUCLEAR AIR CLEANING CONFERENCE

Table II

Loss of iodine sample D_L due to wall deposition in a 30 m long, 12.5 m diameter sampling line, at 100 lpm sampling flow

| Exposure Conditions | | | Deposition Loss D (%) | | | |
|---------------------|---------------------------|---------|-----------------------|--------------|---------------|----------|
| Iodine Form | Relative Humidity % (±3%) | Surface | L | | | |
| | | | Copper | Carbon Steel | Stainl. Steel | Aluminum |
| I ₂ | 5 | N.Cl. | 76.2 | 21.7 | 12.1 | 5.9 |
| | | Ch.Cl. | 80.8 | 54.6 | 46.5 | 11.5 |
| | 97 | N.Cl. | 77.9 | 60.7 | 68.3 | 43.7 |
| | | Ch.Cl. | 80.8 | 83.4 | 76.7 | 72.5 |
| HOI | 5 | N.Cl. | 0.7 | 1.0 | 0.3 | 0.1 |
| | | Ch.Cl. | 9.6 | 0.6 | 2.3 | 1.8 |
| | 97 | N.Cl. | 14.6 | 1.4 | 1.3 | 0.7 |
| | | Ch.Cl. | 17.6 | 2.7 | 3.1 | 3.9 |
| CH ₃ I | 5 | N.Cl. | 0.001 | 0.006 | 0.007 | 0.006 |
| | | Ch.Cl. | 0.007 | 0.006 | 0.005 | 0.01 |
| | 97 | N.Cl. | 0.005 | 0.003 | 0.006 | 0.003 |
| | | Ch.Cl. | 0.005 | 0.003 | 0.006 | 0.10 |

The measured deposition velocities of airborne I₂, HOI and CH₃I on metal surfaces followed the expected pattern:

$$I_2 > HOI > CH_3I$$

It has been confirmed that the reactive forms of airborne iodine, I₂ and HOI, are more rapidly absorbed on chemically cleaned metal surfaces than on original non-cleaned surfaces. Apparently, surface protection films, eventually oxides, have lower affinity for the reactive forms of airborne iodine. Slightly higher V_g, for HOI absorption on non-cleaned surface of carbon steel at low humidity, was confirmed by repeated measurements. This effect was probably caused by the presence of organic, surface protection components.

Further, it was found that the deposition loss of both I₂ and HOI rapidly increases at high humidity. The rate of copper reaction with HOI was accelerated with high humidity more than the reaction of other tested metals, while no significant change was found on the reaction of copper with elemental iodine vapour. Apparently the above effects result from different redox mechanisms and/or different degree of their involvement in the reaction of the tested metals with airborne I₂ and HOI.

17th DOE NUCLEAR AIR CLEANING CONFERENCE

The results of elemental iodine deposition tests, performed in a "type 2" exposure chamber, were not sufficiently conclusive, because I₂ depletion within the chamber was too rapid. More satisfactory results were obtained from HOI tests, which did not show any significant difference between deposition rates measured under laminar and turbulent flow conditions.

Iodine Deposition on Plastic Surfaces

The values of both measured deposition velocity and calculated deposition losses, are listed in Table III.

Table III

Measured deposition velocity values V_g and sample loss D_L from iodine deposition in a 30m long, 12.5 mm ID sampling line, at 100 lpm flow

| Exposure Conditions | | | Tested Plastics | | | | | | | |
|---------------------|---------------------------|---------|-----------------------------|---------------------|-----------------------------|---------------------|-----------------------------|---------------------|-----------------------------|---------------------|
| Iodine Form | Relative Humidity % (±3%) | Surface | Polyvinylchlor. | | Polyethylene | | Teflon | | "Buna N" | |
| | | | V _g -1 m.s | D _L % | V _g -1 m.s | D _L % | V _g -1 m.s | D _L % | V _g -1 m.s | D _L % |
| I ₂ | 5 | NC1 | 1.0(-3) | 51.2 | 4.0(-5) | 2.8 | 3.5(-4) | 22.2 | 2.0(-3) | 76.2 |
| | 97 | NC1 | 2.7(-3) | 85.6 | 1.5(-4) | 10.2 | 2.0(-4) | 13.4 | 2.7(-3) | 85.6 |
| HOI | 5 | NC1 | 1.2(-3) | 57.8 | 3.3(-4) | 21.1 | 2.5(-6) | 0.2 | 1.5(-3) | 65.9 |
| | 97 | NC1 | 1.3(-3) | 60.7 | 2.2(-4) | 14.6 | 9.5(-6) | 0.7 | 1.6(-3) | 68.3 |
| CH ₃ I | 5 | NC1 | 3.4(-6) | 0.24 | 1.0(-6) | 0.07 | 3.4(-7) | 0.02 | 1.9(-6) | 0.14 |
| | 97 | NC1 | 6.0(-6) | 0.43 | 3.2(-7) | 0.02 | 2.5(-7) | 0.02 | 4.5(-6) | 0.32 |

The measured deposition velocities also followed the pattern:

$$I_2 > HOI > CH_3I$$

The deposition of HOI was much more efficient on plastic than metal surfaces. Polyvinylchloride and rubber have significantly higher affinity for I₂, HOI and CH₃I than the affinity of teflon and polyethylene. However, I₂ and HOI react with teflon and polyethylene in rather interesting ways:

The deposition of I₂ is more rapid on teflon than on polyethylene. On the contrary, HOI has much higher affinity for polyethylene. Also the sorption of both I₂ on teflon and HOI on polyethylene is more efficient under low humidity conditions. Apparently physical adsorption contributes, to some degree, to iodine species deposition on plastic materials.

VII. Conclusions

The following conclusions have been made from the results of this experimental study:

- Deposition rates of I_2 , HOI and CH_3I on raw surfaces of tested metals are in the following order:

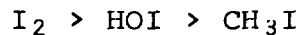

Copper > Carbon Steel > Stainless Steel > Aluminum

Aluminum is the optimal metal for the construction of sampling lines.

- Significant loss of elemental iodine, due to its wall deposition, occurs in carbon steel and stainless steel sampling lines, > 10 m long, under typical sampling conditions.
- High humidity significantly increases deposition loss of I_2 on tested metals, with the exception of copper.
- The deposition loss of HOI in 30 m long sampling lines, made of aluminum, stainless steel or carbon steel, are within acceptable limits.
- Practically no CH_3I loss occurs in sampling lines from wall deposition on tested metals.
- Gaskets and other components, made of polyvinylchloride or rubber are to be avoided in iodine sampling systems.
- The use of polyethylene will minimize deposition loss of elemental iodine.
- Teflon is the optimal material for systems, sampling airborne radioiodines in which HOI is the major component.
- The deposition loss of CH_3I on plastic materials can also be neglected.

Maximal loss of iodine samples occurs under accidental release conditions, when I_2 and HOI are the major iodine forms and high humidity is present in the effluent stream, particularly during initial stages of the accident. Graphical comparison of three optimal materials is made in Figure 4, which illustrates the fraction F of elemental iodine, and HOI reaching a sample collector, for any sampling line length up to 30 m, diameter 12.5 mm, at sample flow of 100 lpm and 97% RH.

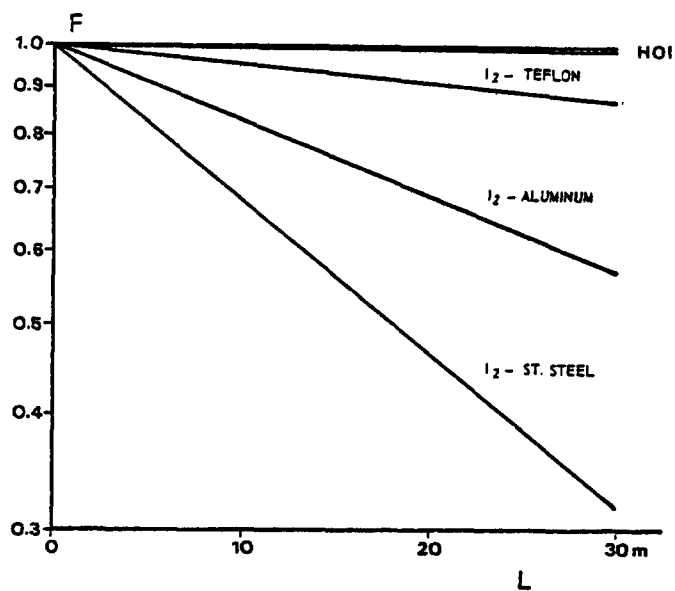

Figure 4

Fraction (F) of elemental iodine, reaching sample collectors through sampling lines up to 30 m long, at 12.7 mm diameter, 100 lpm flow.

It is evident from this graph that under the above conditions, minimal deposition loss of iodine sample would happen in teflon lined aluminum sampling line. It is logical that both length and internal diameter of the sampling line should be minimized to obtain sample with the least possible loss.

REFERENCES

1. ANSI N13.1-1969, Guide to Sampling Airborne Radioactive Materials in Nuclear Facilities.
2. M.J. Kabat, Recent Developments in Gaseous Effluent Monitoring in Ontario Hydro. IAEA Symposium "Monitoring of Radioactive Effluents from Nuclear Facilities". pp. 261-276, Portoroz, Yugoslavia, 1978.
3. P.J. Barry, Sampling for Airborne Radioiodine by Copper Screens. Health Physics, 15, pp. 243-250, 1968.
4. M.J. Kabat, Selective Sampling of Hypoiodous Acid. 14th ERDA Air Cleaning Conference, Sun Valley, Idaho, August 1976, Proceed. pp 490-506.

DISCUSSION

DEITZ: How were the tubing samples cleaned before the test?

KABAT: Copper, carbon steel and stainless steel were etched in HCl, and aluminum in NaOH solutions. The procedure is briefly described in paragraph IV of this paper.

WILHELM: I wish to point out that the adsorption of radioiodine species will be much affected by impurities and dust, which will plateout on the walls of the sampling tubes. Under accident conditions, condensation of water is to be expected and should be avoided by heating. Short length of sampling tube, large tube diameter, and high air velocity are important for reliable results.

KABAT: Yes, condensed moisture, oil, and dust deposits will have significant effect on deposition loss of iodine species. Most materials will increase the loss of elemental iodine. Oil and most other organic deposits will increase the loss of HOI. Therefore, I have recommended that sampling lines be flushed with chemically inert solvents at intervals determined from the rate of deposition of impurities. I am not aware of any experimental data on the effect of tracer heating on the loss of iodine species. I suspect that iodine chemisorption and the rate of corrosion of internal surfaces would be accelerated with increased temperature.

DEUBER: It might be worthwhile to mention that we have found negligible deposition of I₂ in sampling lines of polyethylene (lengths greater than 10 m) used in nuclear power stations for several years.

KABAT: This observation is in good agreement with our results, listed in Table III.

17th DOE NUCLEAR AIR CLEANING CONFERENCE

BURCHSTED: Jesse Thomas gave a discussion on sizing sampling lines in the 9th or 10th Air Cleaning Conference, and his information, including equations for calculating size, was summarized in The Nuclear Air Cleaning Handbook. Mr. Wilhelm's comment reiterates Thomas' conclusions, which were to keep sampling lines large, short, and as near vertical as possible.

KABAT: Almost all previous work on airborne activity sampling lines was related to particulate samples. When designing delivery lines for both particles and radioiodine, it must be considered that some recommendations for particulate sampling line sizing and materials and for sample collectors might contradict recommendations for optimal sampling of airborne radioiodine species. For example, the use of equation ($Q/d = 150$) for the optimal size of

sampling lines would cause unacceptable loss of iodine samples. Deposition loss of I_2 in a stainless steel line of 12.5 mm dia., 1 m long, would increase from 3.7 to 33.5% under conditions in Table II of this paper. Under the same conditions, more than 90% sample loss of I_2 would occur in a 7 m long sampling line. Further, we have recommended sole use of pure glass fiber filters as a particulate collector, when installed upstream of iodine sample collectors. We found that filters based on cellulose, synthetic fibers, and metallic fibers retained significant portions of gaseous I_2 and HOI.

BANGART: Please comment on the influence of sample flow velocity on iodine deposition. Some plants in the U.S. are planning to sample at a velocity of approximately 0.06 cfm over sample line lengths of tens of meters in order to minimize buildup of activity on the cartridges.

KABAT: An "as high as practical" flow should be applied to minimize the residence time of iodine in a sampling line. There are certain contradictions in optimizing for particulate and iodine sampline, which were discussed in my answer to the previous comment. Therefore, sampling lines should be optimized for the more critical component i.e., for radioiodine or for larger particles. From Table I, it can be derived that sample velocity of 0.06 cfm would result in an unacceptable deposition loss of elemental iodine in lines >0.5 in. diameter, >10 m long.

BURCHSTEAD: There has been much speculation about the existance of HOI over several air cleaning conferences. Is this HOI really a serious consideration?

KABAT: I cannot comment on the significance of HOI in U.S. nuclear power stations because I do not have experimental data on airborne radioiodines in light water reactors. However, HOI was identified to be the major airborne iodine species in Candu nuclear power stations. The results of our field measurements were summarized in a paper presented at the IAEA Seminar "The Testing and Operation of Off-gas Cleaning Systems at Nuclear Facilities", held in Karlsruhe in May 1982. The title of this paper is "Canadian Nuclear Air Cleaning Standards and their Application in Ontario Hydro".

17th DOE NUCLEAR AIR CLEANING CONFERENCE

KOVACH, J.L.: In all other investigative studies, it was found that HOI was an artifact of the adsorbent used and both ORNL and AECL studies show that HOI does not exist in the vapor phase. How do you justify identifying products as HOI and, is the existence of HOI a formal position of Ontario Hydro, or is its existence your personal opinion?

KABAT: The challenge is quite clear. However, its basis is somewhat inaccurate. I shall try to rectify the major points.

1. I have never seen a published statement that "HOI was an artifact of the adsorbent used." In the past, some doubts were expressed about the existence of HOI as a result of preliminary theoretical considerations. However, no conclusion was made in the recent ORNL and AECL studies on iodine chemistry, that "HOI does not exist in the vapour phase." On the contrary, I quote R. Lemire (AECL): "Based on currently available thermodynamic data, the predominant chemical form of iodine in the gas phase is predicted to be HOI except under moderately oxidizing conditions where I_2 and HOI would be present in roughly equal concentrations."

2. The reaction of pure elemental iodine with distilled water is generally recognized to be hydrolysis, resulting in the formation of HI and HOI, as primary products. Since we have experimentally established that gaseous species released from dilute aqueous solutions of elemental iodine are not iodine vapour or HI, we consider the presence of HOI to be sufficiently evident from the above elementary facts. (HOI might also occur in clustered or hydrated forms under certain conditions.) Most results of our experimental studies on the chemical behaviour of this volatile product of iodine hydrolysis have substantiated this interpretation. Further, absorption characteristics of the major airborne radioiodine species, which we have identified in Candu power stations, are identical with the properties of HOI generated in a laboratory under controlled conditions from diluted aqueous solutions of elemental iodine.

3. The answer is, no. The existence of HOI is not just my personal opinion. The requirements for testing charcoals for HOI removal efficiency have been included in the CSA N288.3 Standard. Many technical comments and recommendations had been received from AECL, Ontario Hydro, AECB, and other organizations before the standard was approved. However, no negative comment was received and no doubt was expressed on the existence of HOI and on its inclusion into charcoal testing requirements.

Several experts in U.S.A. (particularly at Science Applications, Inc.) have measured and reported the occurrence of airborne HOI in U.S. nuclear power stations. Amazingly, charcoal samples from TMI-2 were also evaluated by NUCON for its HOI removal efficiency.

17th DOE NUCLEAR AIR CLEANING CONFERENCE

To summarize my position:

From our developmental work on the chemistry of airborne radioiodines and from field applications we introduced and systematically performed during the last ten years, we have learned that (1) much practical experience in "low concentration iodine chemistry", (2) a very thorough and systematic experimental approach, and primarily (3) the availability of a dependable species selective monitoring system are essential for successful generation, isolation, and determination of airborne HOI. It is a highly reactive compound and it is unstable at concentrations which would be detectable with classical physico-chemical methods. Several attempts were made in some laboratories to determine airborne HOI, which did not meet with much success. Therefore, several investigators have taken a reserved position on its existence. However, good portions of data can be found which support the claim of the existence of airborne HOI in nuclear power stations, operational areas, and gaseous effluents.

Even at very low concentrations, HO^{131}I presents a very significant radiobiological hazard (1 ppb $\sim 10^8$ MPC_a occupational). No business or personal interest has ever been involved in our investigations and its existence is not for us a matter of academic discussions. We are directly responsible for the protection of our occupational personnel and the public. We cannot admit any superficiality or major omissions in the control of airborne radioiodine hazard. Therefore, our effort still continues, to improve the understanding of its properties and to develop optimal methods for its efficient control, monitoring, and personal protection. The possibility of this product being identified as another chemical compound of iodine is very remote because no other realistic alternative has ever been suggested. However, even if this ever happens, its behaviour will be reasonably understood and its hazard well under control.

CLOSING REMARKS OF SESSION CHAIRMAN:

I would like to wrap up the session with a brief summary. We had seven papers and a lot of new information. R. T. Jubin studied the use of silver mordenite adsorbents for the recover of methyl iodide and found that the pickup of methyl iodide is comparable to elemental iodine. This is new information because four years ago we weren't sure that these materials would work for organic iodide. Operating temperature is about 200°C. Water vapor has a positive effect, NO_x has no effect, and now he is looking at the use of partial exchanged silver zeolites, 5-10% by weight, to maximize the use of silver. He has done some preliminary cost estimations and it looks to be between \$500,000 and \$700,000/y for a full size reprocessing plant.

Mr. Shiomi studied the removal efficiencies of methyl iodide on charcoal and silver exchange zeolites as a function of five variables—bed length, packing density, temperature, relative humidity, and face velocity. The important thing is that it was done with new adsorbents in the absence of contaminants. We are all aware that weathering and contamination drastically change the performance of a bed. He did a semi-empirical fit of data to an equation that has four constants and five variables. My concern would be that the four constants would change each time there is a new batch of material or there are contaminants on the adsorbent or agent. This remains a problem.

Mr. Mulcey gave a paper on in situ testing and performance of iodine adsorbents in French nuclear facilities and their pressurized water reactor. French law requires an annual check, and in some cases a three month check, on beds in continuous use. They use a tracer method with elemental iodine or methyl iodide. They believe this gives them the actual performance of the adsorbent in situ, rather than a leak test, such as is used in the U.S. They have found the following problems: (1) The lifetime of some of the traps is less than six months, a very short time. (2) It is difficult to get equal flow through parallel beds. We have the same problem in this country. (3) Defective assembly construction means leakage around the frame. A comparable problem here. They believe that the tracer method is costly and difficult and would like to partially supplement it with a leak test in between the initial installation test and retests every two years using the radioactive tracer technique. They found no correlation between efficiency and face velocity or relative humidity in the in situ test.

Mr. Rouyer has been doing laboratory testing of iodine adsorbents in French facilities using a German material, AC 6120, which has been thoroughly demonstrated in their reprocessing facilities by both hot and cold testing. The French are planning to install this adsorbent in their French nuclear reprocessing facilities by the end of 1986. This, I might add, is the only silver exchange adsorbent of silver nitrate on silicic acid that has been tested in hot service, in actual plant dissolver offgas.

17th DOE NUCLEAR AIR CLEANING CONFERENCE

Dr. Deuber gave a review paper on iodine adsorbents to see if they would meet the new German guidelines of September 4th that require iodine efficiency of 99.9%. In the case of the design basis accident, or a loss of coolant type accident, these adsorbents would have to survive and operate at temperatures as high as 150° C and relative humidity less than 10% for ten hours, and then, perhaps, drop down to 30° C and relative humidity of 100% for two months. So the question is, would they provide the kind of efficiency under these conditions. Dr. Deuber looked at about ten variables i.e., base material, particle size, impregnant service life, radiation field, iodine concentration, iodine species, temperature, relative humidity, face velocity, residence time, and purging time. Can you imagine an equation which describes all the parameters at once? It is very complicated. It was concluded that deep beds of potassium iodide impregnated charcoals would provide the necessary decontamination factors.

Dr. Scholten has been testing the performance of charcoal adsorbents in the Netherlands nuclear power plant. I believe it is a PWR. Initially, they found problems in that the material would last less than three months and they would have to pull out the whole bed containing several tons of charcoal. They were aware of repeated advice by Dr. Melvin First, for example, that they should have had a guard bed. Dr. Wilhelm has indicated that they should use a bigger bed. To solve this problem, they installed a guard bed in front, 1/10th the size of their iodine adsorbent bed, and changed it every three months instead of the adsorbent bed. At least, they have 1/10th the waste they would have had otherwise, so I would say that is a pretty good technique although they still don't get away from the problem that they have organic contaminants in the atmosphere that have to be removed.

Dr. Kabat studied the deposition of gaseous radioiodine species in sampling lines and I think this information will be very useful for up-dating ACN 13.1 for sampling methodology. He found that the deposition rates followed a trend where elemental iodine is the worst (something we have always known), that HOI is next, and methyl iodide is the least problem. He looked at four different metals and found that aluminum is the best metal, i.e., has the least deposition. He recommends that we avoid polyvinyl chloride and rubber type materials. Polyethylene is the best for elemental iodine and Teflon is best for HOI. He has attempted to calculate the deposition rate to determine the fraction that might be lost.