

Session 5

## FILTRATION AND FILTER TESTING I

TUESDAY: August 3, 1982

Co-CHAIRMEN: H.T. Ettinger, Los Alamos  
National Laboratory

B.V. Gerber, US Army ARRADCOM  
Chemical Systems Lab.

VERTICAL REMOVABLE FILTERS IN SHIELDED CASING FOR RADIOACTIVE  
CELLS AND PROCESS GASEOUS WASTES  
M. Prinz

DEVELOPMENT OF FILTERS AND HOUSINGS FOR USE ON ACTIVE PLANT  
S. Hackney, R.P. Pratt

AEROSOL FILTRATION WITH METALLIC FIBROUS FILTERS  
M. Klein, W.R.A. Goossens

EVALUATION OF PERMANENTLY CHARGED ELECTROFIBROUS FILTERS  
A.H. Biermann, B.Y. Lum, W. Bergman

EVALUATION OF PROTOTYPE ELECTROFIBROUS FILTERS FOR NUCLEAR  
VENTILATION DUCTS  
W. Bergman, W.D. Kuhl, A.H. Biermann, J.S. Johnson, B.Y. Lum

A NEW METHOD OF DETERMINING THE OVERALL PARTICLE DECONTAMINATION  
FACTOR FOR MULTIPLE OFF-GAS CLEANING COMPONENTS IN REPROCESSING  
PLANTS  
J. Furrer, A. Linek

IN-SITU CONTROL OF FILTRATION SYSTEMS IN FRANCE: 5 YEARS  
EXPERIENCE  
J. DuPoux

## CONTAMINATION CONTROL AND PERSONNEL PROTECTION

AIR CLEANING PHILOSOPHY IN A NUCLEAR MATERIALS FABRICATION  
PLANT  
F.Y. Ward, R.E. Yoder

SYSTEM OPERATIONAL TESTING OF MAJOR VENTILATION SYSTEMS FOR  
A PLUTONIUM RECOVERY FACILITY  
F.J. Linck, Jr.

## 17th DOE NUCLEAR AIR CLEANING CONFERENCE

### VERTICAL REMOVABLE FILTERS IN SHIELDED CASING FOR RADIOACTIVE CELLS AND PROCESS GASEOUS WASTES

M. Prinz  
Ventilation Department  
S.G.N.  
(Société Générale pour les Techniques Nouvelles)  
Saint Quentin en Yvelines - France

#### Abstract

The installation of shielded filtration casing is necessary for highly contaminated active cells (for example, fuel bundle shearing cells of reprocessing plants) and process gaseous wastes containing active aerosols.

SGN and COGEMA have developed a filtration casing equipped with a vertically removable filter element.

Two types of casing have been developed :

- one for a flow rate of 500 m<sup>3</sup>/hr,
- one for a flow rate of 3000 m<sup>3</sup>/hr.

The filter elements are fitted with high efficiency glass fibre media. They are cylindrical in shape. The top flange of the filter is equipped with a gasket to ensure sealing between the filter element and its casing.

The filter element is blindly installed and removed and its orientation, inside the casing, is immaterial.

The shielding casing is made of a cast iron, or steel, shielding slab under which is secured the filtration casing itself. This shielding slab is settled on side shielding walls made of concrete or cast iron.

The filter element, integral with a plug, is placed in the horizontal slab.

The attachment of the filter element under the plug is made necessary for the following two reasons :

- a) so that the plug and filter may be removed as one unit,
- b) to keep the filter on its sealing surfaces, according to sealing and seismic resistance requirements.

Filter removal is performed with the help of an intervention cask, centered over a removable trap door provided on the shielding slab of the casing.

First, the plug and filter element assembly is raised into the cask.

Then, the filtering element may be separated from the plug which is decontaminated and salvaged. The whole plug and filter assembly may also be sent to the conditioning waste storage.

The installation of a clean filter element in the casing, is also performed

## 17th DOE NUCLEAR AIR CLEANING CONFERENCE

with the help of the intervention cask, proceeding as above, but in reverse order.

The same intervention cask may also be used to remove the upstream and downstream dampers from the top of the casing.

The casings are provided with pressure pick-up points enabling pressure measurement on site, in accordance with usual regulations.

### I - Introduction

In some cases, the ventilation of active cells and gaseous wastes necessitates the installation of shielded casings.

There exist some shielded casings suitable for 1250 m<sup>3</sup>/hr output filters, from which the filter element can be removed horizontally.

The intervention cask accommodating the filter is placed against the front face of the casing and enables withdrawal under  $\alpha . \gamma$  protection.

The protective doors open vertically or horizontally and the filter element is pulled inside the intervention cask with the help of a rod.

The doors are then shut, awaiting the introduction of a new filter element.

This system is at present in use in French reprocessing plants but its main drawback is the difficult handling of the casing protection door latches and the horizontal withdrawal of the horizontal filter element inside the intervention cask.

A new type of shielded casing has been developed for use in projected new reprocessing plants. This new type of casing enables withdrawal under  $\alpha . \gamma$  protection and differs from existing casings in that the filter element can be installed or withdrawn vertically.

### II - Why vertical handling ?

Filter element installation or withdrawal operations form part of the installation maintenance program.

#### Maintenance

This covers all the operations normally carried out to keep the installation in a state of permanent working condition and safety while the plants are in production.

These operations are the object of procedures laid down during plant design and testing.

#### Personnel protection

Maintenance operations must be carried out in normal working conditions, while observing the following criteria :

- sustained containment,

## 17th DOE NUCLEAR AIR CLEANING CONFERENCE

- limitation of equivalent activity level sustained by the operator,
- working position and protective clothing as little constraining as possible,
- limitation of risks for the operators, even of non-nuclear nature.

The maintenance operations may be carried out in accordance with established criteria, taking into account the activities and the qualification of anti-radiation equipment.

### Risk of external exposure

To remain within the exposure limit of 0.5 Rem/year, the level equivalent per operator is limited, during maintenance operations, to :

- 2.5 mRem/working hour, for the whole body,
- 30 mRem/working hour, for the hands.

Since the collective level is to be kept down to the minimum, the maintenance operations are so designed that the number of operators required is as small as possible.

### III - Equipment design for modular exchange

The filtering equipment comes within that group of equipment which can be maintained through an exchange of module.

There are some standardized modular units common to several workshops and to several items of equipment :

- for standardization purposes, a series of devices is designed to enable modular exchange in a remote maintenance cask.

These standardized modular devices are designed in such a way that :

- their role of containment barrier is fulfilled during normal operation,
- their connection with the remote maintenance cask is ensured without containment failure during the maintenance operation,
- the amount of radioactive material they retain is kept down to the minimum,
- they may be rinsed and cleaned, provided that these operations are compatible with the process and with safety.

### IV - Application to filtration casing

The filtration casings used on contaminated cells and on gaseous waste systems must be shielded.

Indeed, such filters can trap a high level of activity and the dust retained can be a transmitting source of  $\alpha$  .  $\gamma$  radiation.

The installation and the removal of filter elements located inside shielding casings must comply with plant maintenance operation and modular exchange concept criteria.

## 17th DOE NUCLEAR AIR CLEANING CONFERENCE

In order to use the remote maintenance cask employed for all other modular assemblies, it has been necessary to completely redesign the filtration casings used on the installations.

Since the modular assemblies are evacuated vertically, and blindly, the casing and the filter have been designed accordingly.

The first step was to design a filter element capable of meeting the above requirements.

### Determination of filter element output

In the reprocessing plants, the two systems likely to necessitate the presence of shielded filtration casings are those used for processing and gaseous wastes and those used for exhausting areas with a high contamination risk.

In most cases, the gaseous waste systems have a low ventilation flow rate. Following a study of existing plants and another study concerning future plants, it appears that a gaseous waste exhaust flow rate of 500 m<sup>3</sup>/hr is often used.

The process gaseous waste filter therefore has an output of 500 m<sup>3</sup>/hr.

The exhaust of cells with a high risk of contamination necessitates a much larger flow rate.

The 610 x 610 x 292 mm HEPA (THE) small pleats filters provide a maximum output of 3000 m<sup>3</sup>/hr, with a pressure drop of 25 mmCE.

In order to enable the standardization of the installations and for dimensional reasons, a 3000 m<sup>3</sup>/hr output exhaust filter element has been selected for the ventilation system of cells presenting a high risk of contamination.

### V - Why was a cylindrical filter element selected ?

The filter element installation and removal operations are carried out blindly. It is therefore impossible to accurately locate a filter on its sealing surface.

This is the reason why filter elements of cylindrical design have been selected.

### VI - Description of filter elements

#### 500 m<sup>3</sup>/hr output filter element (see fig. 1)

##### Filtered air characteristics

- steady flow temperature : 50°C
- max. temperature : 120°C
- corrosion : high risk
- activity : greater than 1000 MPC

— FIGURE.1 —

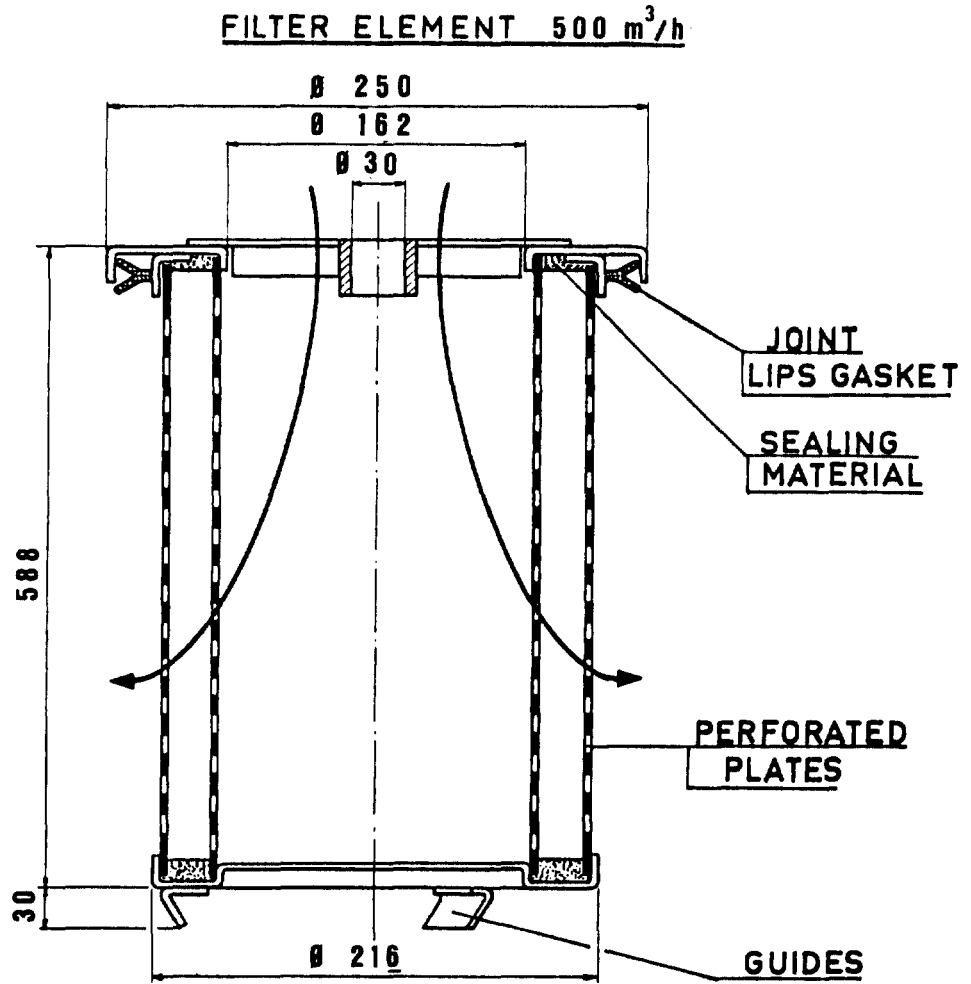

FILTER IN LITTLE PLEATS

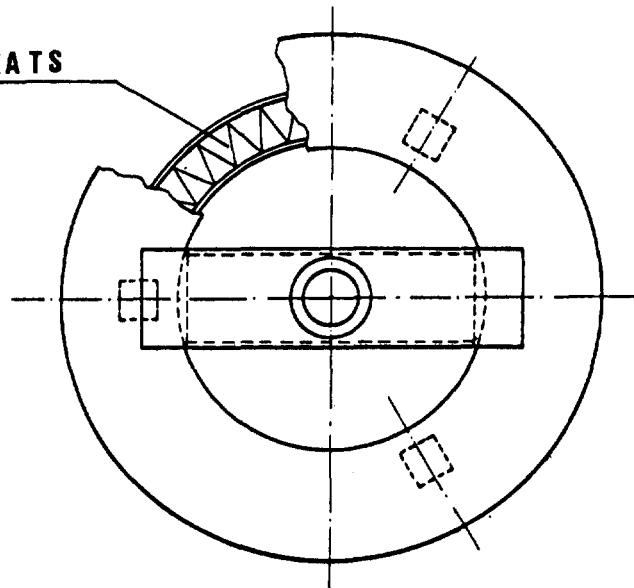

## 17th DOE NUCLEAR AIR CLEANING CONFERENCE

### Dimensions of filter element

- outside diameter	: 250 mm
- height	: 618 mm
- effective area	: 5 m <sup>2</sup>
- diff. pressure at nominal flow rate	: 26 mmCE
- velocity over paper	: 2.7 cm/s
- filtering coefficient (average uranine granulometry = 0.15 micron)	: greater than 5000
- decontamination factor	: 99.98% efficiency
- DOP - NaCl. efficiency	: 99.99%
- disposal in a 200 litre capacity drum	: 500 mm dia. x 790 mm high
- weight of filter element	: 5 kg

### Description of filter element

The filter element designed and produced by SOFILTRA POELMAN is composed of a layer of glass fibre paper complying with standard MIL F 51079 B, with 20 mm pleats, reinforced with glass thread.

This layer is sandwiched between two perforated stainless steel sheets providing the necessary mechanical strength and protection of the filter paper.

The filter element is fitted with a dished bottom flange and an annular top flange accommodating the sealing gasket.

Sealing, between the filter paper and these stainless steel end fittings is provided by means of a PVC compound with the following characteristics :

- good resistance to acids,
- good resistance to heat (1 hour at 200°C),
- fire-proof.

Sealing between the filter element and its support is by means of a double-lip seal in contact, on the one hand, with the machined face of the casing and, on the other hand, with the top flange of the filter element. Sealing is ensured by the mere weight of the filter element (5 kg).

The grabbing device is welded to the top flange of the filter element.

### 3000 m<sup>3</sup>/hr output filter element (see fig. 2)

#### Filtered air characteristics

- steady flow temperature	: 12 to 50°C
- max. temperature	: 120°C

— FIGURE.2 —

FILTER ELEMENT 3000 m<sup>3</sup>/h

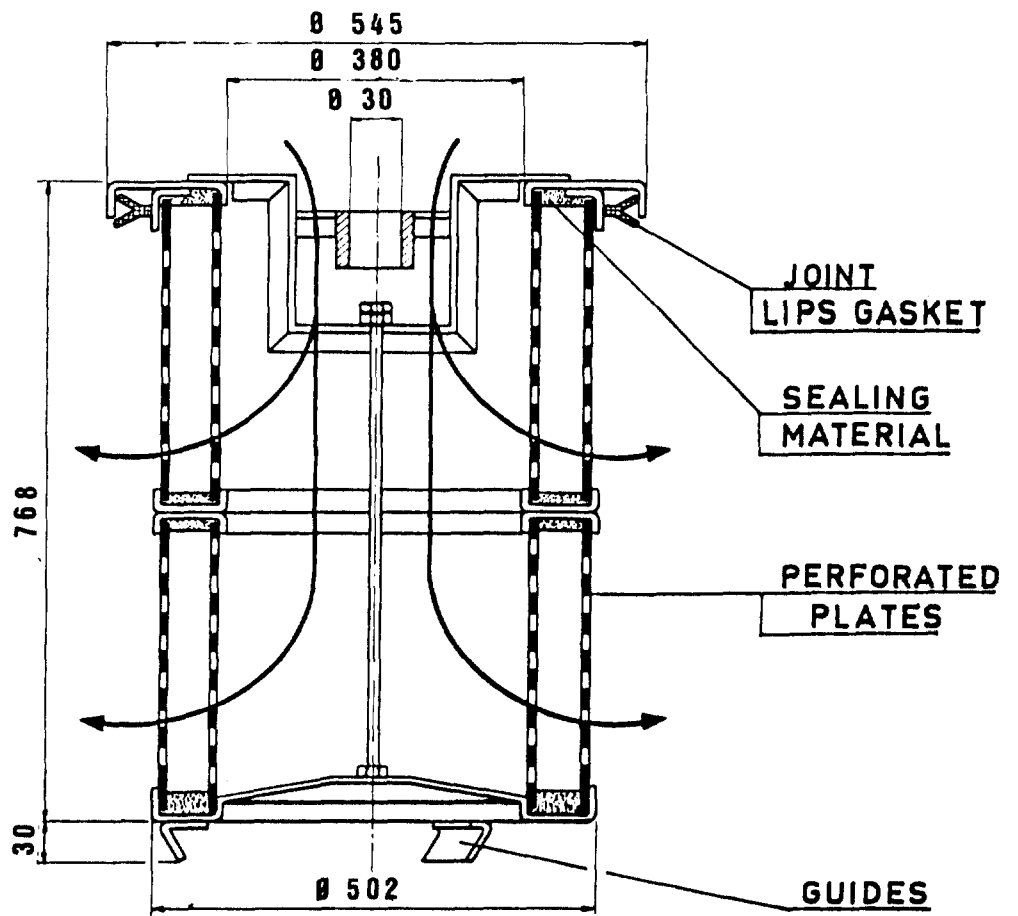

FILTER IN LITTLE PLEATS

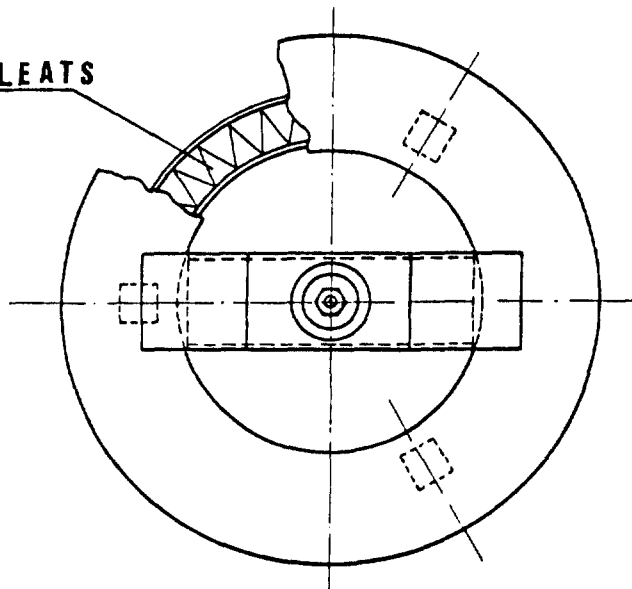



## 17th DOE NUCLEAR AIR CLEANING CONFERENCE

- corrosion : high risk
- activity : greater than 1000 MPC

### Dimensions of filter element

- outside diameter : 545 mm
- height : 798 mm
- effective area : 33 m<sup>2</sup>
- diff. pressure at nominal flow rate : 23 mmCE
- velocity over paper : 2.5 cm/s
- filtering coefficient (uranine) : greater than 5000
- decontamination factor : 99.98% efficiency
- DOP - NaCl. efficiency : 99.99%
- disposal in a 400 litre capacity drum : 710 mm dia. x 1100 mm high
- weight of filter element : 20 kg

### Description of filter element

The filter element is composed of a layer of glass fibre paper complying with standard MIL F 51079 B, with 50 mm pleats, reinforced with glass thread.

The layers are sandwiched between two perforated stainless steel sheets.

For production reasons, the filter element is made up of two superposed cylindrical sections and an intermediate seal.

A central safety draw-bolt provides the mechanical link between the bottom end of the filter and the grabbing device.

## VII - Casing design criteria

Two filtration casings were designed : one accommodating a 500 m<sup>3</sup>/hr output filter element and the other a 3000 m<sup>3</sup>/hr output filter element.

### Common design for both filtration casings

Design : These casings are designed so as to enable filter element isolation and removal under a remote maintenance cask while keeping contamination containment and protection within regulation limits.

Functional requirements : The air enters at the top of the filter so that the dust remains at the bottom of the filter element.

Seism : In case of seism, the filter elements must remain in their normal working position.

## 17th DOE NUCLEAR AIR CLEANING CONFERENCE

Weight and size : The size of the filter elements is dictated by the dimensions of the corresponding storage drums which are :

- capacity drum : 200 litre or 400 litre

Operational requirements : Removal of filter element through the top of the casing, under  $\alpha . \gamma$  protection.

Availability - Reliability : These filtration casings are used permanently. The continuity of the filtration must be ensured during maintenance and while the filter elements are being changed.

The average service life of the filter elements depends upon :

- clogging, which itself depends on the amount of dust contained in the air to be filtered and on the maximum design pressure differential.
- the rate of irradiation (radioprotection check).

Maintenance : Casing maintenance ensures the highest possible level of availability, consequently :

- the casing is designed so that, in case of breakdown, repair is carried out as quickly as possible,
- the most sensitive elements, such as the isolation dampers, are designed so as to allow easy disassembly in the remote maintenance cask.

Safety - Equipment inherent safety system : The casings are provided with a biological shield, to protect the operators.

Specific precautionary measures : To prevent corrosion, metallic parts will be made of stainless steel.

Behaviour requirements : It must be possible to replace a defective damper. If the filter element is incorrectly installed, the installation operation must be repeated.

### VIII - Description of casing (see fig. 3)

The filtration casing accommodates the filter element and is equipped with isolation valves.

- the 500 m<sup>3</sup>/hr output casing weighs 500 kg
- the 3000 m<sup>3</sup>/hr output casing weighs 2000 kg.

The filtration casing is composed of :

- an horizontal, protective cast iron slab.

The casing and its two upstream and downstream dampers are fixed to the protective slab.

— FIGURE 3 —

FILTRATION CASING

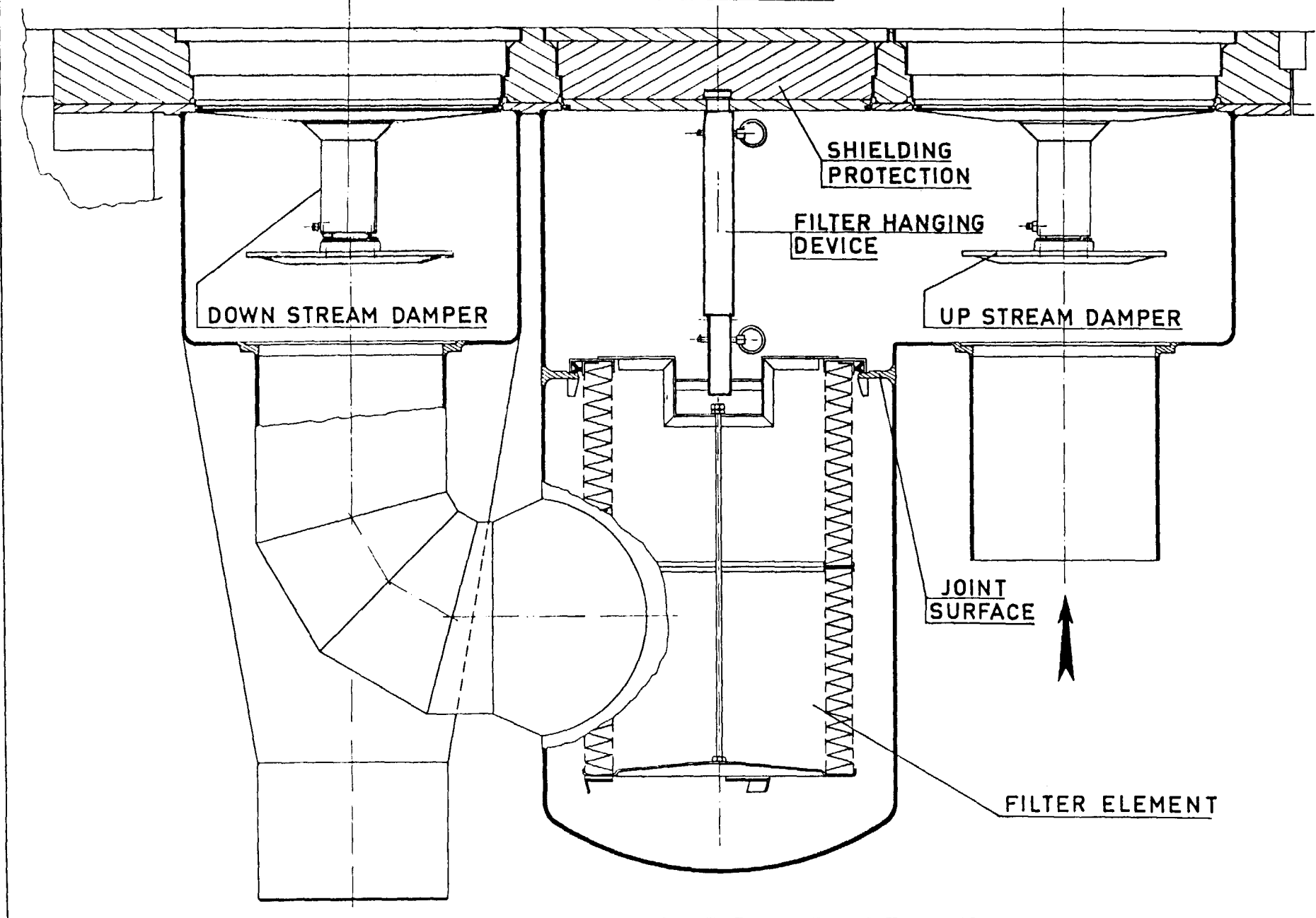

## 17th DOE NUCLEAR AIR CLEANING CONFERENCE

The filter element can be secured under a plug located inside the protective slab.

The dampers are secured under the plugs provided in the protective slab.

### Attachment of filter element

The filter element is hooked under the plug with the help of an element comprising :

- 1) a link pin, securing the filter element supporting rod to the plug,
- 2) a spring mechanism, pressing the filter element against its sealing surface.
- 3) a link pin, securing the filter element to its supporting rod.

### Attachment of dampers :

The dampers are secured under plugs by means of supporting rods allowing them to move vertically in both directions.

The plugs supporting the dampers and the filter element of a 500 m<sup>3</sup>/hr output casing, are of identical diameter : 300 mm.

Similarly, the plugs supporting the dampers and the filter element of a 3000 m<sup>3</sup>/hr output filtration casing, are of identical diameter : 580 mm.

- these plugs are fitted in the protective slab where they are adequately secured.
- sealing is obtained by means of a gasket housed in a groove under the plug.
- the damper position is indicated by an index flush with the protective surface when the damper is open.

It is thus possible to know whether the damper is open or shut.

The protective slab, casing and damper assembly may be rested upon lateral steel shields or upon concrete shields, depending upon the amount of space which may be used.

### IX - Filter element removal/installation

(see fig.4 )

The filter element is removed and installed from the top end of the filtration casing.

The casing isolation dampers are shut and a cover is placed upon the casing to protect the environment.

A remote maintenance cask is then placed over the cover and the trap doors provided on the remote maintenance cask and on the cover are open, to enable the withdrawal of the plug and filter element assembly from the filtration casing, into the maintenance cask.

— FIGURE 4 —

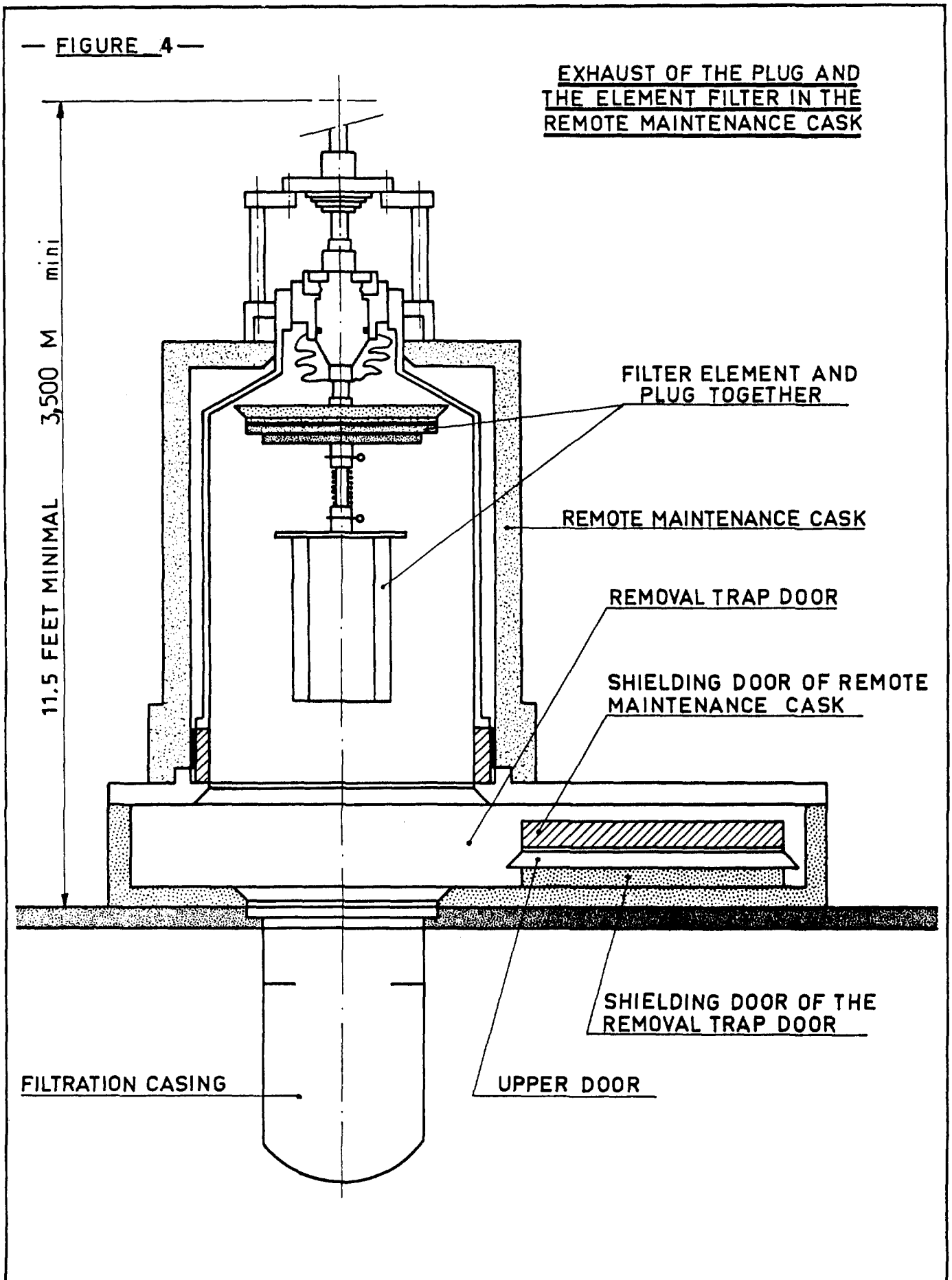

## 17th DOE NUCLEAR AIR CLEANING CONFERENCE

The protective trap doors are shut and the remote maintenance cask containing the active filter can be evacuated.

Another remote maintenance cask containing a clean filter and plug assembly is then placed over the cover.

The trap doors of the cover and maintenance cask are opened and the filter element is lowered into the filtration casing, regardless of its orientation, since both the filter element and its plug are cylindrical.

The spring located in the supporting rod presses the filter element against its seat, under the load applied by the plug.

The remote maintenance cask and cover are taken away.

It is then possible to open the filtration casing isolation dampers and carry out the tests which will show whether or not the filter element is correctly seated on its support.

### Variant (see figs. 5 and 6)

The plugs may be designed for immediate re-use. In such a case, the filter element is not attached to the plug located in the protective slab. The plug is equipped with a spring rod which presses the filter element against its seat but when the plug is raised by means of a remote maintenance cask, the filter element remains in position. A second remote maintenance cask can then be used to withdraw the filter element provided with a grabbing device.

A new filter element, located in a third remote maintenance cask, is then lowered in position in the filtration casing and the plug lowered on top of it.

This solution presents the advantage of using lower remote maintenance casks since the absence of the plug enables the vertical stroke of the maintenance cask mechanism to be reduced to the height of the filter element, i.e. 780 mm, plus the height of the grabbing system.

Another advantage of this solution resides in the fact that the plug can be re-used immediately, thus limiting the number of technological wastes.

The only drawback of this solution is the increased amount of handling, during filter element removal and installation operations.

Both these solutions may be used with the type of filtration casing described herein.

— FIGURE.5 —

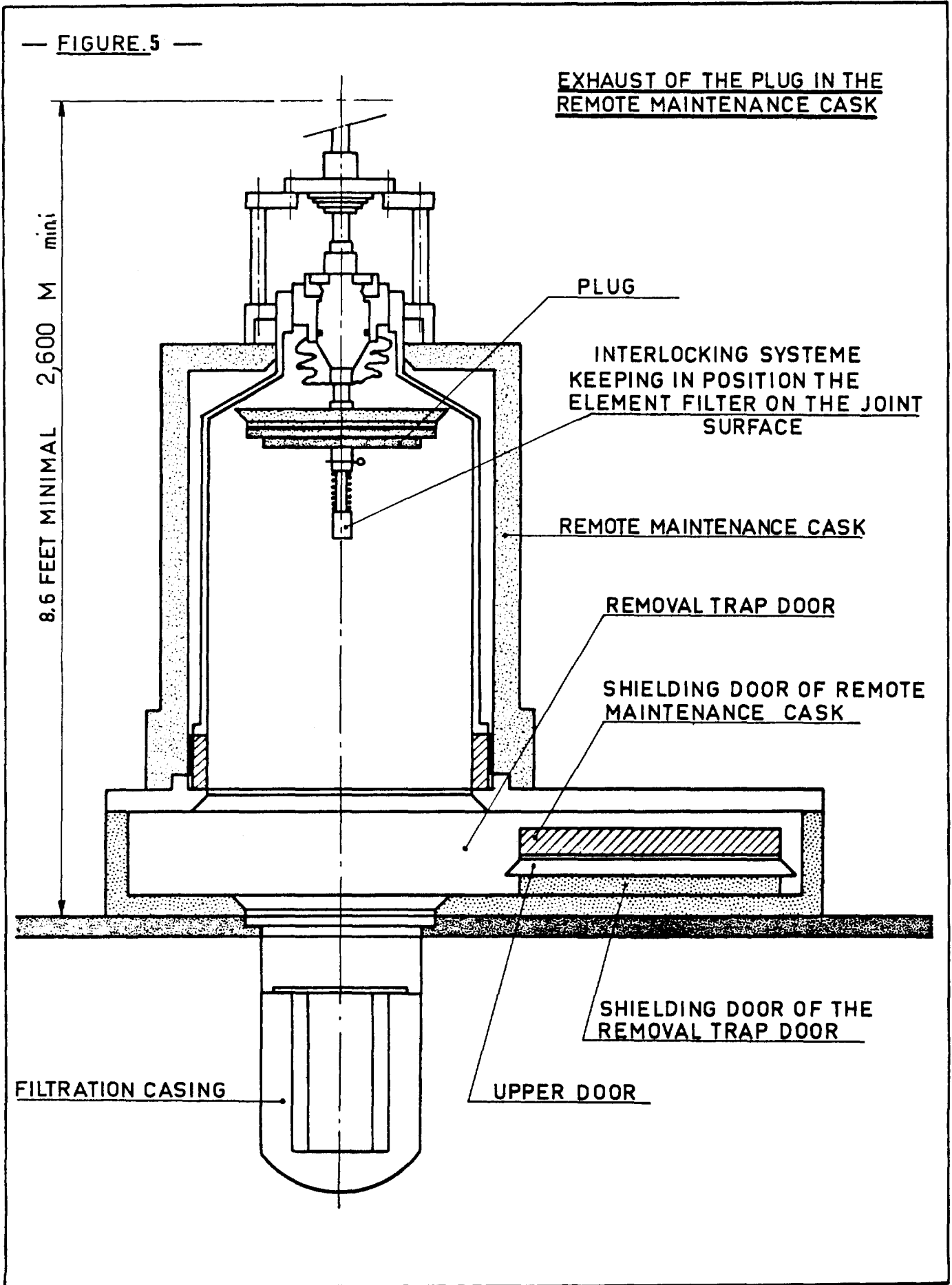

— FIGURE.6 —

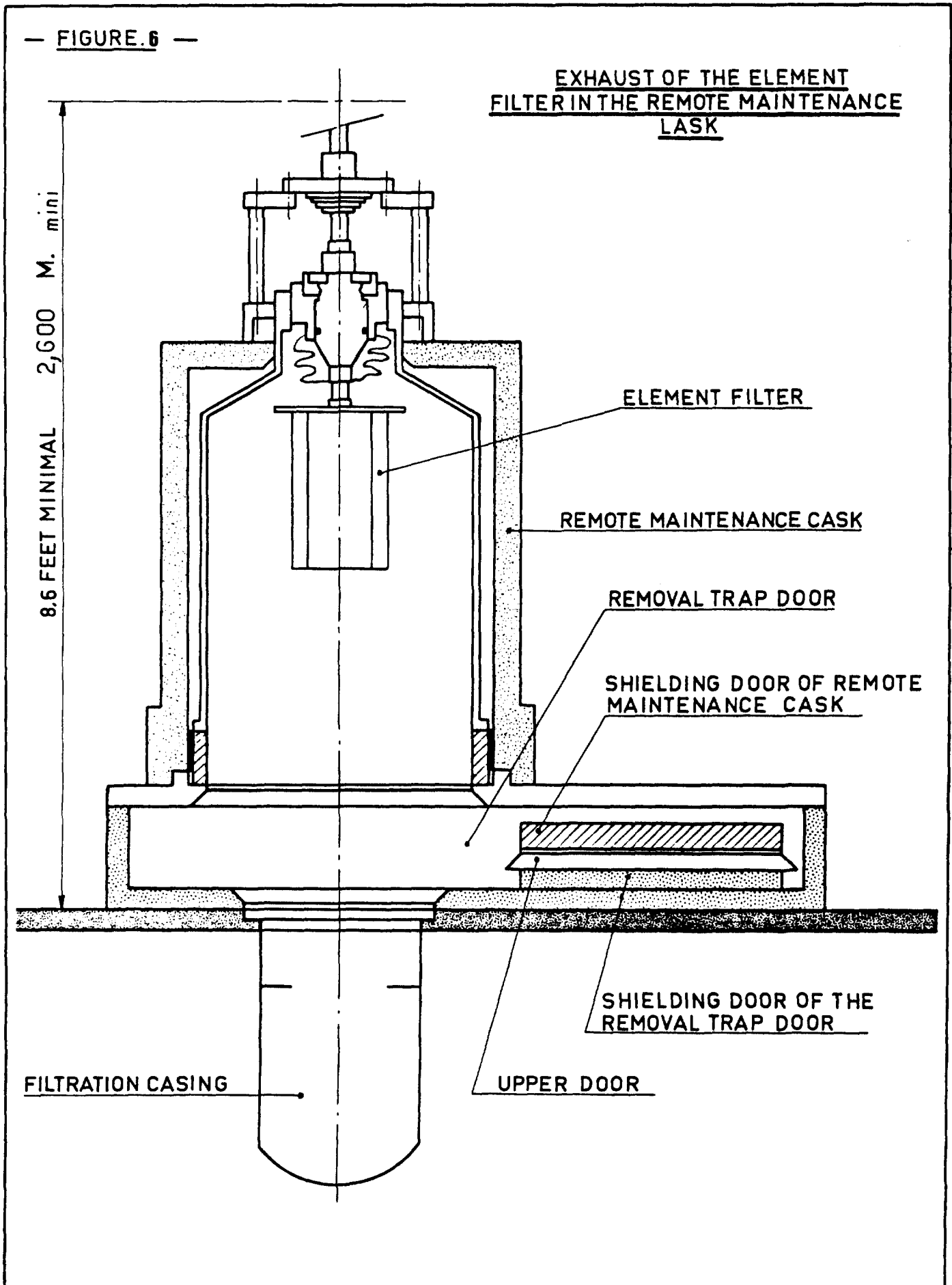



X - DIFFERENT KIND OF USED OF FILTRATION CASING

- ONE STAGE CASING WITH TWO SHIELDED DAMPERS

	L	l	D
500 m <sup>3</sup> /h	1400	1030	960
3000 m <sup>3</sup> /h	2450	1520	1560

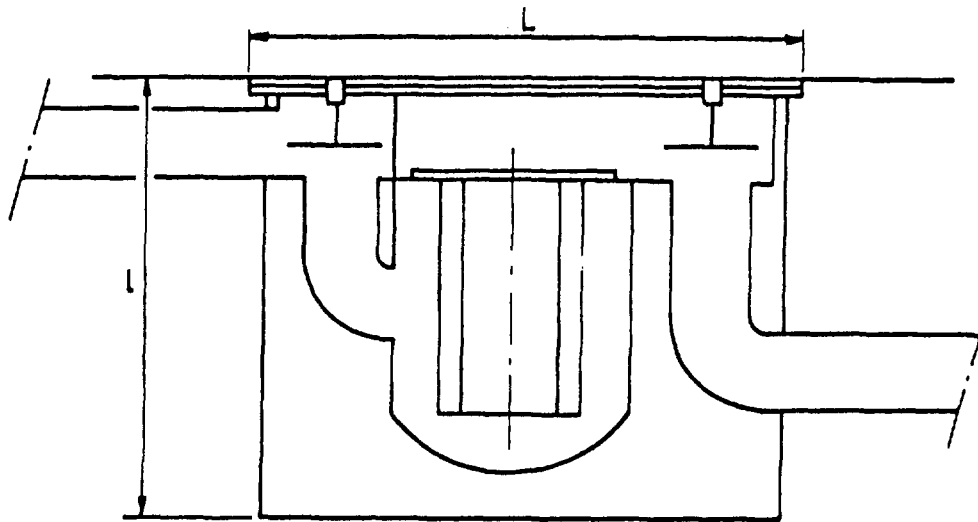

- ONE STAGE CASING WITH ONE UPSTREAM SHIELDED DAMPER

THE DOWN STREAM DAMPER IS CONSTITUED WITH A NO SHIELDED REMOVAL DAMPER

	L	l	D
500 m <sup>3</sup> /h	1200	1030	900
3000 m <sup>3</sup> /h	2100	1520	1160

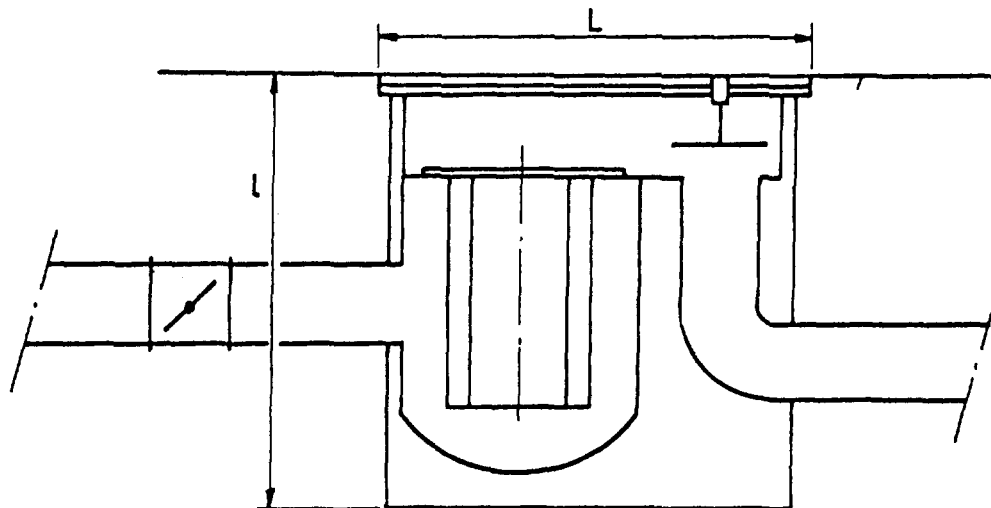

TWO STAGES CASINGS WITH TWO SHIELDED DAMPERS  
 IT IS NOT NECESSARY TO PUT THE DAMPERS BETWEEN THE  
 TWO STAGES

	L	l	D
500 m <sup>3</sup> /h	1800	1030	900
3000 m <sup>3</sup> /h	3250	1520	1370

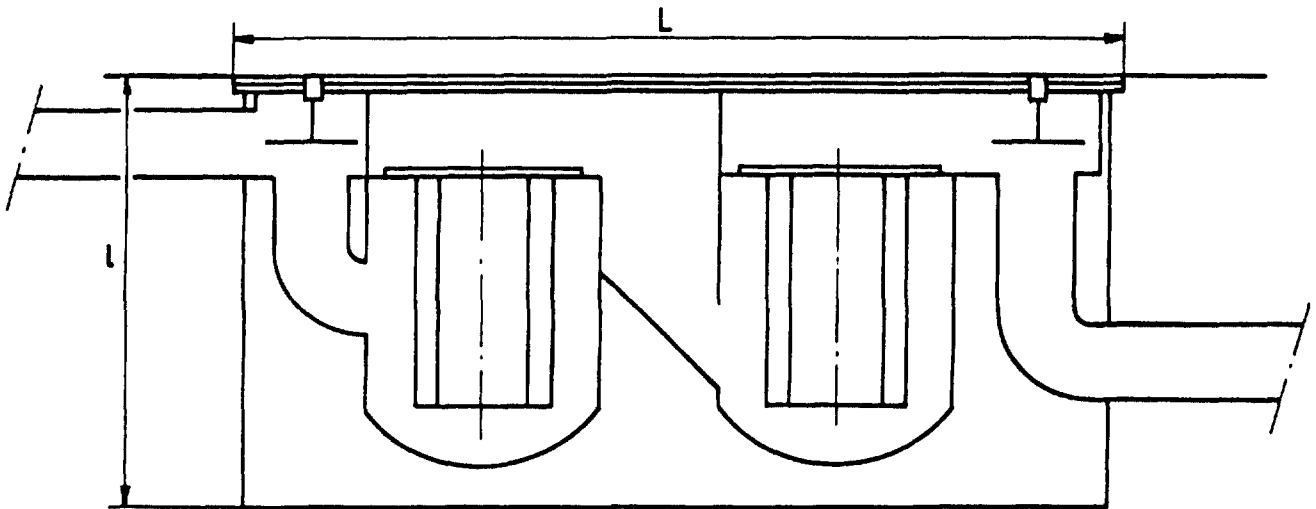

TWO STAGES CASINGS WITH ONE UPSTREAM SHIELDED DAMPER  
 THE DOWN STREAM DAMPER IS CONSTITUED WITH A NO  
 SHIELDED DAMPER

	L	l	D
500 m <sup>3</sup> /h	1760	1030	900
3000 m <sup>3</sup> /h	2730	1520	1160

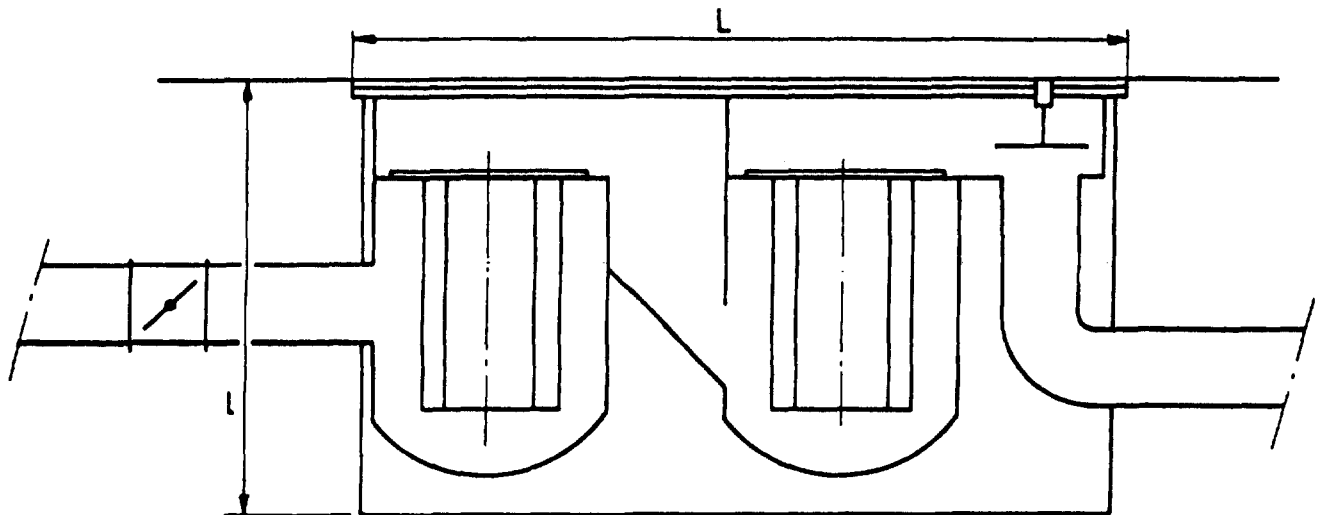

## 17th DOE NUCLEAR AIR CLEANING CONFERENCE

### XI - Filtration casing tests

The 500 m<sup>3</sup>/hr and 3000 m<sup>3</sup>/hr filtration casings and their installations are designed to enable testing in situ.

In order to take measurements by the normally used methods, some pressure inlet and outlet points are provided.

#### Two-stage filtration casing

To enable the testing of the 2nd stage, and improve the homogeneity of the aerosol/air mixture, a metal plate is fitted between the 2 stages in order to set up a turbulence at the outlet of the 1st stage of filtration.

#### Pressure drop measurements

##### 3000 m<sup>3</sup>/hr output casing, with clean filter and 2 shielded dampers :

<u>Flow rate</u>	<u>Casing</u>	<u>Filter</u>	<u>TOTAL</u>
2000 m <sup>3</sup> /hr	17.0 mmCE	14.0 mmCE	31.0 mmCE
3000 m <sup>3</sup> /hr	40.0 mmCE	23.0 mmCE	63.0 mmCE
4000 m <sup>3</sup> /hr	70.0 mmCE	31.5 mmCE	101.5 mmCE

##### 500 m<sup>3</sup>/hr output casing, with clean filter and 2 shielded dampers :

<u>Flow rate</u>	<u>Casing</u>	<u>Filter</u>	<u>TOTAL</u>
400 m <sup>3</sup> /hr	19 mmCE	20 mmCE	39 mmCE
500 m <sup>3</sup> /hr	31 mmCE	26 mmCE	57 mmCE
600 m <sup>3</sup> /hr	45 mmCE	33 mmCE	78 mmCE

##### 3000 m<sup>3</sup>/hr output two-stage casing, with clean filters and 2 shielded dampers :

<u>Flow rate</u>	<u>Casing</u>	<u>Filter</u>	<u>TOTAL</u>
2000 m <sup>3</sup> /hr	34 mmCE	28 mmCE	62 mmCE
3000 m <sup>3</sup> /hr	69 mmCE	46 mmCE	115 mmCE
4000 m <sup>3</sup> /hr	117 mmCE	63 mmCE	180 mmCE

### XII - French reprocessing plant applications

These filtration casings will be used in the ventilation installations of reprocessing plants, in France.

They will be installed in the process wastes ventilation and high-level contamination cell exhaust systems.



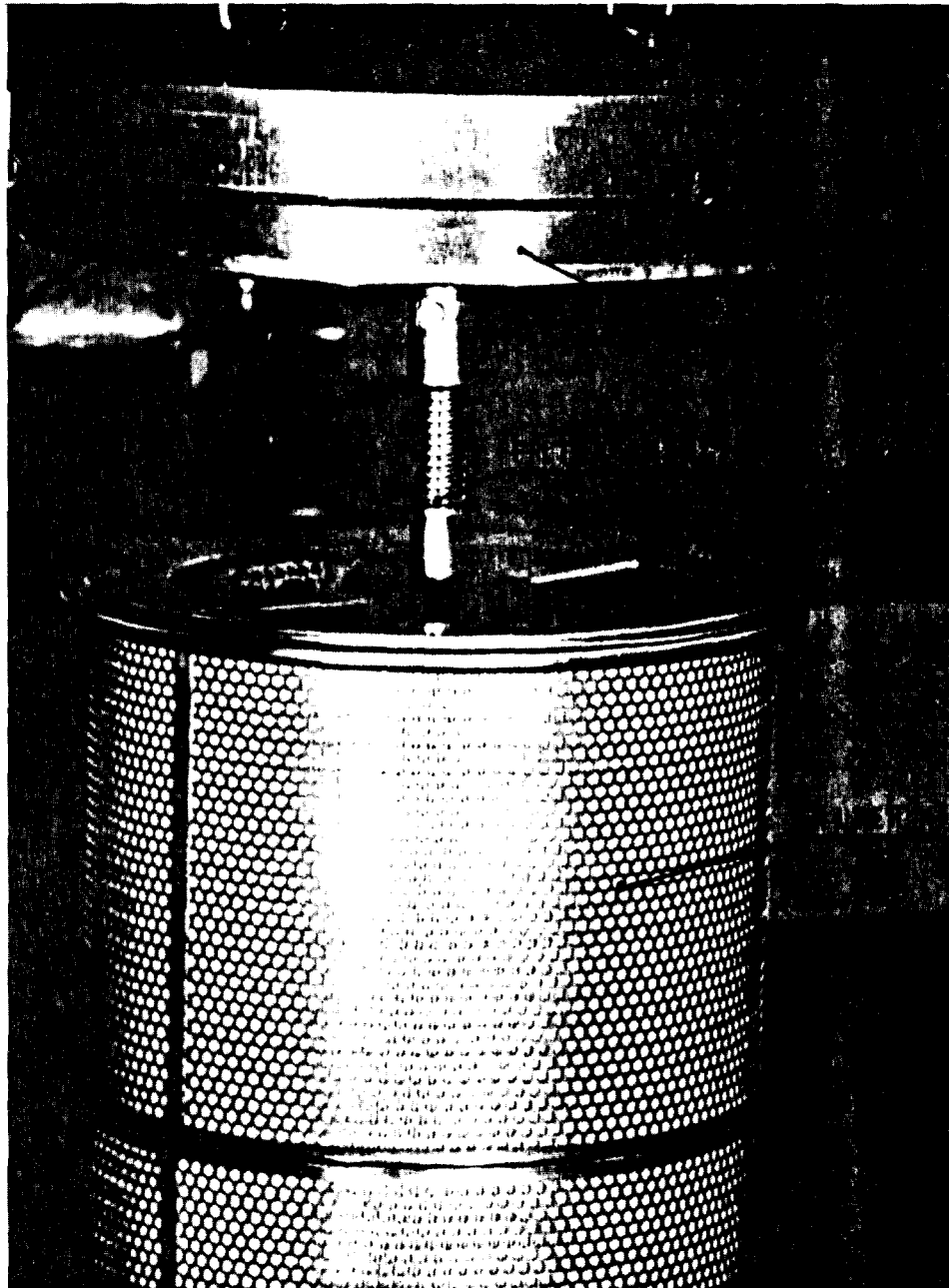



filtration casing 3000 m<sup>3</sup>/h

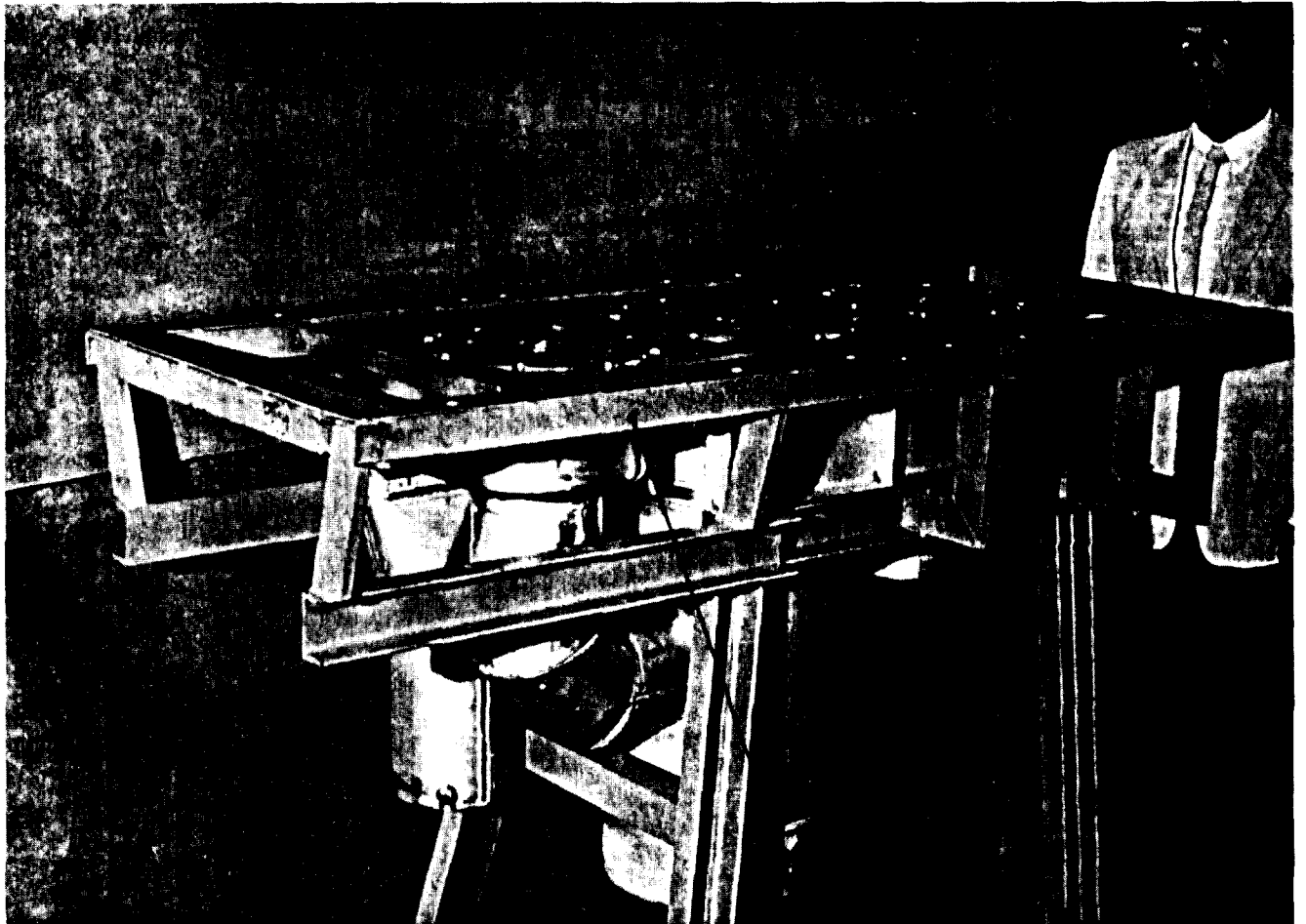

filtration casing 500 m<sup>3</sup>/h





DISCUSSION

GERBER: How has the integrity of the installed filters been measured?

PRINZ: The casing is equipped with inlet and outlet points to verify the integrity of the filtration. The measurement is made by normally used methods with uranium aerosol according to French Standard AFNOR X99011.

BERGMAN: Does the air enter the cylindrical filter from the inside or outside of the cylindrical filter element? The reason I ask is because of the metallic screen on the outside. We have found that if a metallic screen with small openings is on the upstream side of the filter it acts as a template to effectively eliminate large portions of the effective filtering element.

PRINZ: Surely the stainless steel perforated plate acts as a template before the filtering element. Nevertheless, the open section is about 70% of the face area. These plates ensure protection of the filter paper and the rigidity of the filter element. We have decided to direct the flow from the inside to the outside, thereby losing a part of the filtration surface because the dust will then be retained in a sort of pocket and can be better confined, particularly when we move the filter element into the remote maintenance cask, and during the cask travel.

WATSON: How do you dispose of the filters? Can they be compressed?

PRINZ: The 500 m<sup>3</sup>/h filter element can be disposed of in a 200 liter capacity drum and the 3,000 m<sup>3</sup>/h filter element can be disposed of in a 400 l capacity drum. These two drums, situated in the decontamination facility, can be compressed. When the remote maintenance cask brings the plug plus the filter element 14 into the decontamination cell, the filter element and its plug are separated by withdrawing the link pin securing the filter element to its supporting rod. The perforated stainless steel plate is not very resistant and we can crush the filter element. It is for this reason that for the 3,000 m<sup>3</sup>/h element, the safety draw bolt which provides the mechanical link between the bottom end of the filter and the grabbing device is thin.

DYMENT: At its rated flowrate, the resistance of the filter casing is greater than that of the filter element. What is the reason for designing the housing to have such a high resistance?

PRINZ: The filter element has a pressure drop (for normal conditions) of 24 mm WG. The casing has a pressure drop of 40 mm WG. This pressure drop is due to the several changes in the direction of our flow in the casing, especially the last curve after the downstream damper. But if we look at the pressure drop: 40 mm WG for casing + 24 mm WG for filter + 80 or 100 mm WG for reserve logging, we think that it is not necessary to try to reduce the pressure drop of the casing by an increase in the section. More especially, as this type of filter is used for process gaseous wastes which do not have

**17th DOE NUCLEAR AIR CLEANING CONFERENCE**

very large flow rates. Further, our active cells represent only small part of the ventilation volume of a complete system.

DEVELOPMENT OF FILTERS AND HOUSINGS FOR USE ON ACTIVE PLANT

S. Hackney and R. P. Pratt  
United Kingdom Atomic Energy Authority

**Abstract**

New designs of housings for conventional HEPA filters have been developed and are now in use. A further design is planned for future use. The main features to be developed are the engineering of double door systems to replace bag posting and other methods of filter changing which expose personnel to hazardous environments and the addition of a secondary containment to reduce the role of the gasket seal in the filtration efficiency.

Also under development are circular geometry filters of HEPA standard which offer significant advantages over rectangular filters for applications requiring remote shielded change facilities. Two types of filter construction are being evaluated, conventional radial flow cartridge filters and spiral-wound, axial-flow filters.

The application of circular filters for primary filter systems on active plant is in hand. A push-through change system has been developed for a new cell facility under construction at Harwell. Existing rectangular filters on a high activity cell are being replaced with clusters of small cartridge filters to overcome changing and disposal problems. A similar system but using 1700m<sup>3</sup>/h filters for large volume off-gas treatment is also being studied.

A remote change shielded filter installation is being developed for use in high alpha, beta, gamma extract systems. The design incorporates large cartridge filters in sealed drums with remote transfer and connection to duct work in the facility. A novel application of the use of double-lid technology removes the need for separate shut off dampers and enables the drums to be sealed for all transfer operations.

**I. Square Section Geometry Filter Packs**

**1.1 Introduction**

The particular new designs of filter housings described in this paper came into being from a requirement to eliminate bag-posting of filters in the UK Fast Breeder Reactor Reprocessing and associated facilities programme.

A design was evolved adopting the double door concept of posting which had been in use for some time for the posting of small packages of active materials and waste. A valuable spin-off from this design work, was the introduction of a secondary containment around the filter unit which eliminated the problems associated with the effects of the gasket seal on the filtration efficiency.

The introduction of the secondary containment has led to design proposals in which filters can be changed without isolating the plant and with no loss of filtration efficiency during the process.

**1.2 Design Description**

Figure 1 shows the principle of the secondary containment and the double door isolation in schematic form. The filter is housed in a removable box with a gasket seal on both edges of the casing isolating the primary from the secondary containment. Housed in recesses in the ducts are the plugs which are used to isolate the ducts and the filter box such that the box can be removed and transferred to a facility where the used filter is replaced.

In the operating mode the air is drawn through the filter by the extract fans ensuring that both the entry and exits are below atmospheric pressure. Any leakage via the gasket seals will flow from the secondary containment into the primary. Leakage on the active side will pass through the filter whilst leakage on the filtered side is clean air and therefore of no consequence.

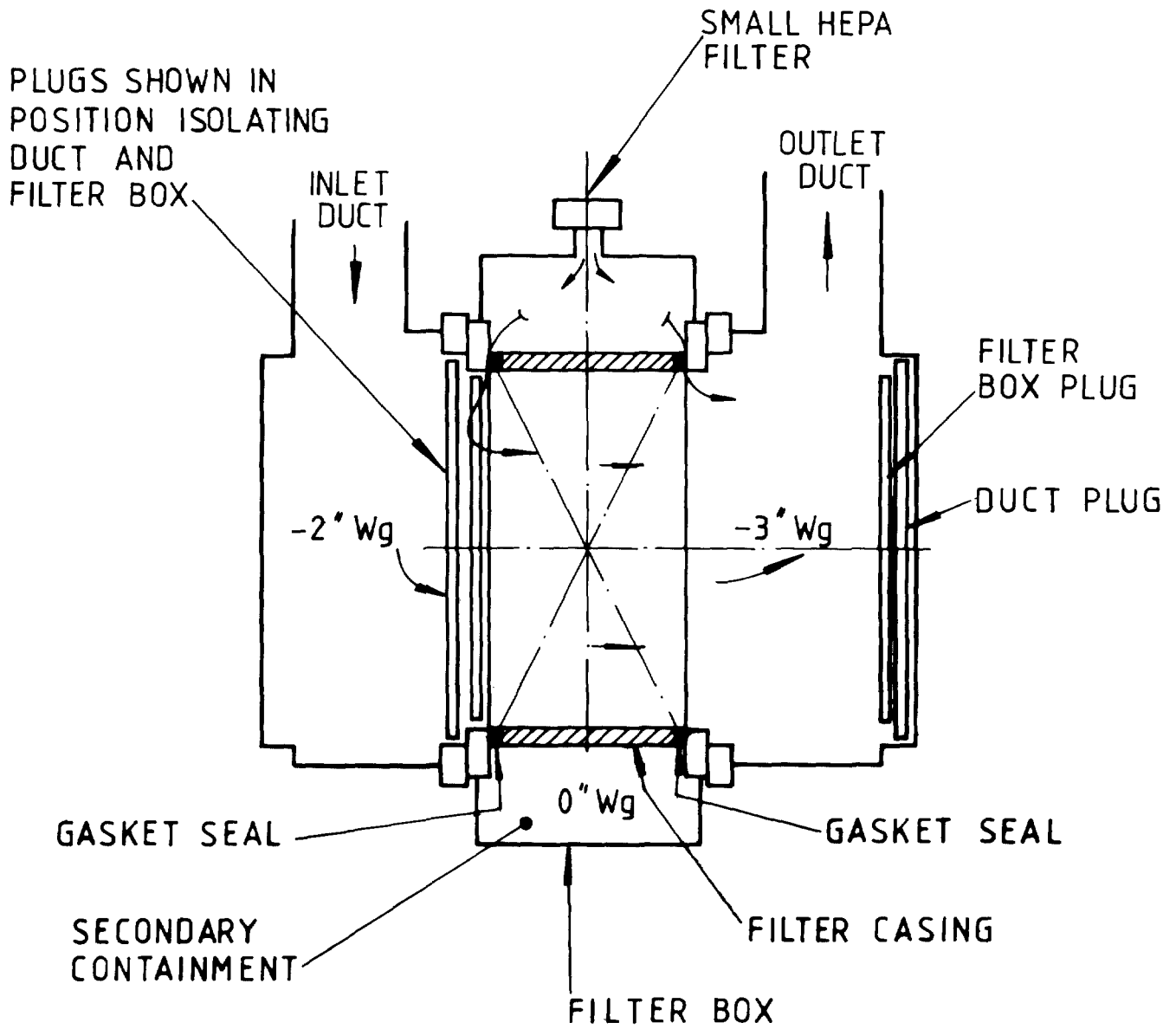

FIGURE 1  
HEPA FILTER HOUSING SCHEMATIC

By-pass of the active air will only occur if the active gasket is leaking and the volume of flow by-passing the gasket on the filtered side is of such a magnitude as to draw down the secondary containment pressure to below the pressure at the filter inlet on the active side. Nominal pressures for each of the air spaces is shown in figure 1 to illustrate the point. The circuit resistance to flow on the secondary containment side is the small filter which is there should a blow-back incident occur. This could be replaced with a flap valve in most cases should it be necessary to increase the by-pass flow capacity.

An alarm can be fitted to the secondary containment, or a monitoring point to detect any pressure difference between that and the atmosphere. This ensures that any gasket deterioration can be detected.

### 1.3 3 x 200 cfm Shielded Housing

This unit as shown in figure 2 consists of a leak-tight box with an air inlet and outlet duct running down each side. These ducts can be isolated by moveable plugs to facilitate filter changing. The filter assembly has a similar plug which is attached to the duct plug and withdrawn to the back of the duct to allow air to pass through the filter. With the filter in the operating position any leakage across the filter gaskets is inwards from the secondary containment surrounding the filter. Flow into the secondary containment is filtered and monitored to detect in-leakage into the primary circuit. The filtration efficiency and plugging of the filters can be checked by isolating each filter in turn.

The filter units complete with end plugs are flaked in and out of the housing with no other form of encapsulation being necessary. There are two plants in operation using this type of primary filtration unit.

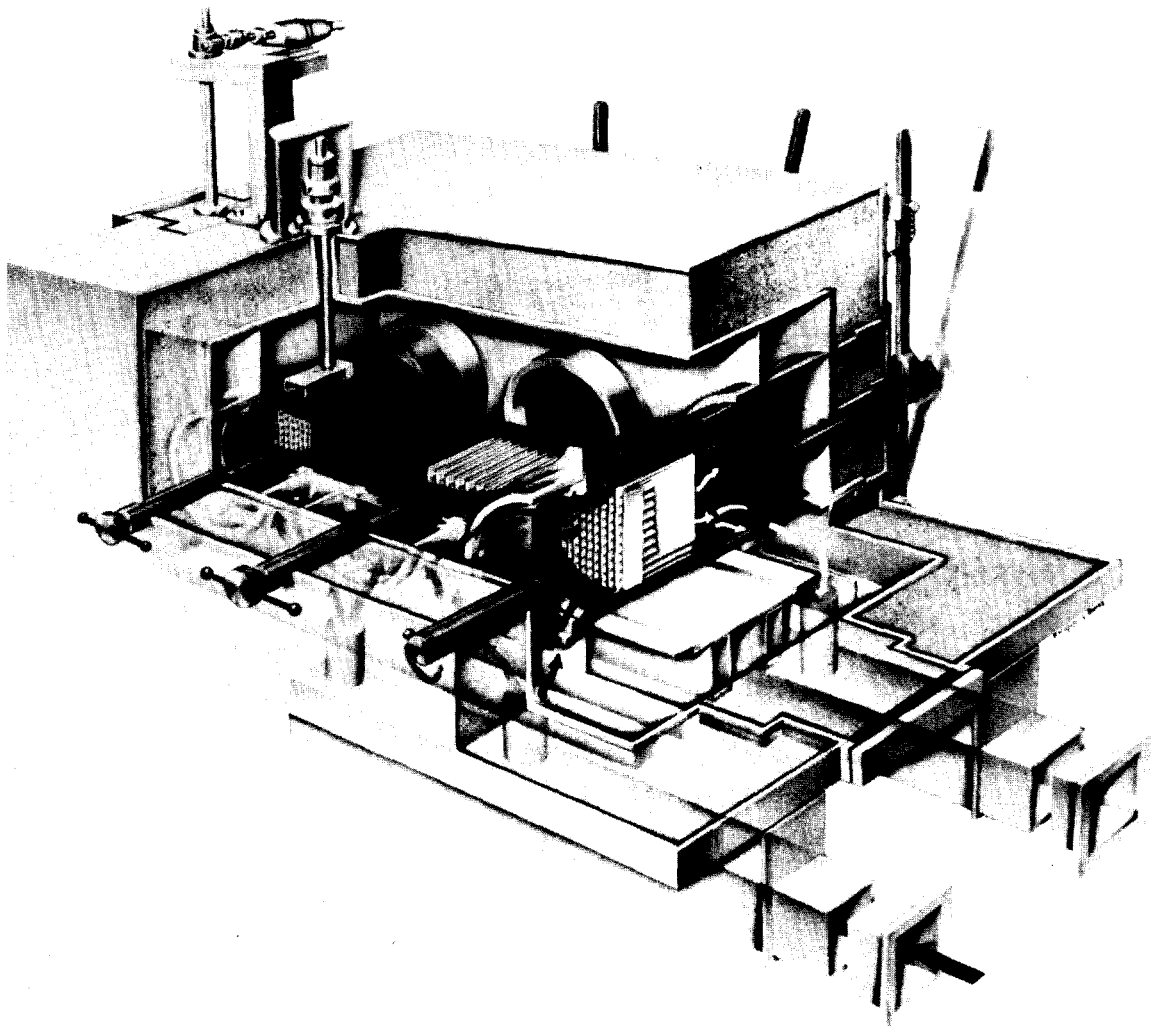

FIGURE 2  
FILTER HOUSING

1.4 Unshielded 1000 cfm Filter Housing

The same principles are applied to the 1000 cfm filter units used in non-shielded applications as illustrated in figure 3. The three main components making up one unit are made of cast aluminium. The box containing the filter is inserted between two housings by swinging the filtered side housing on a sponge rubber hinge. The whole assembly is clamped together using four bolts. The isolating plugs are screwed together and removed to the back of the housings during operations.

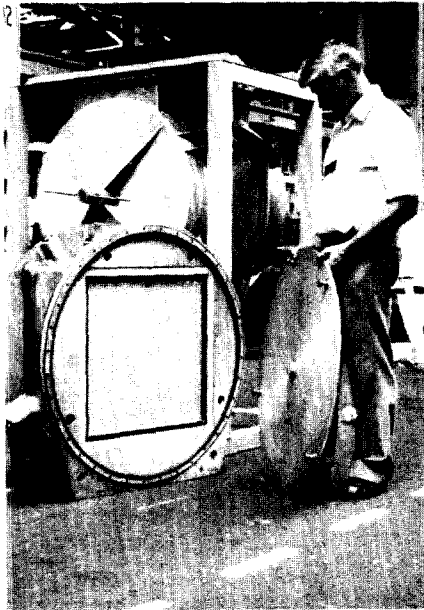

FIGURE 3  
1000 cfm UNSHIELDED FILTER HOUSING

1.5 Filter Posting and Breakdown Facility

The filter box containing the filter is removed to a glove box filter break down facility (see figure 4) where the used filter is replaced with a new one and then the used one is broken down to reduce the waste volume. The filter in its box is inserted between the two glove boxes. Using the gloves the blanking plugs are removed from the glove box and the filter box to gain access to the filter. The filter is removed by inserting the clean filter via the new filter glove box and pushing the spent filter into the breakdown box. The gaskets and blanking plugs are replaced and the filter box is returned with the new filter installed back to the filtration plant.

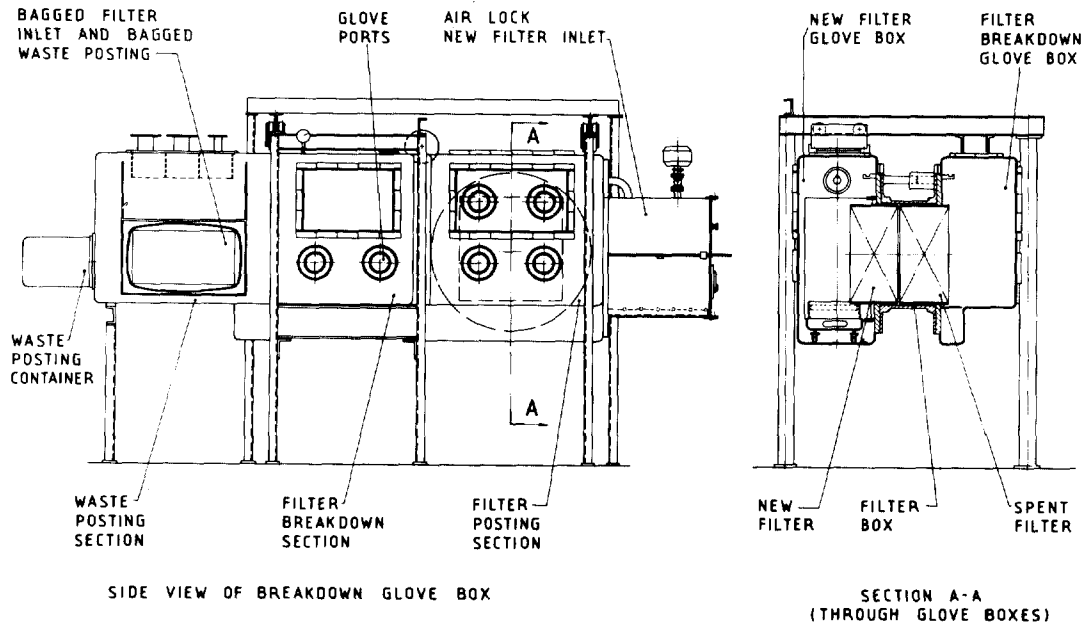

FIGURE 4  
FILTER POSTING AND BREAKDOWN FACILITY

There is something like a total of 24,000 cfm installed capacity in operation at the present time. Figure 5 shows a large proportion of this installed capacity at Dounreay, UK. Consideration is being given to using the high flow filter packs to increase the capacity of the existing plants.

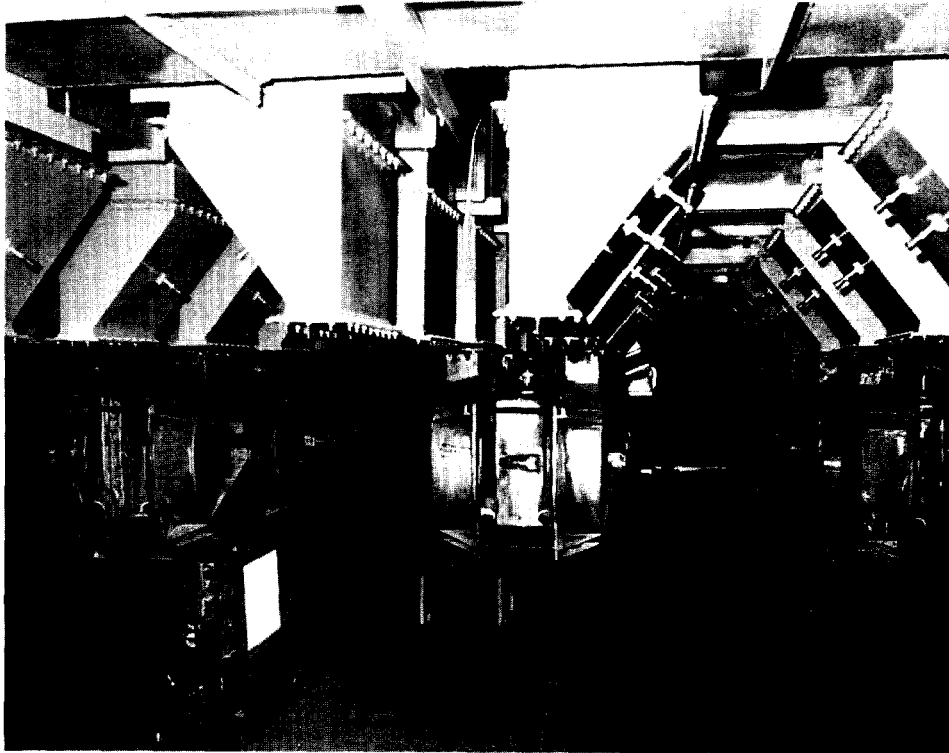

FIGURE 5

### 1.6 Application of the Air Purge to Multi-Unit Plants

The principle of reducing the gasket seal on the filter pack to an order of secondary importance removes some design limitations and results in a much simpler design which is essential for shielded applications.

The improvements are related to the method of mounting and the replacement of the filter pack.

The assembly as illustrated in figure 6 consists of 2 rectangular steel boxes which extend through the shielding and terminate in flanges against which shield doors at either end are sealed. The box is made to contain the filter packs with the gap between the plates maintained to such tolerances as to ensure the gasket seal is compressed enough to maintain a measure of sealing to isolate the primary from the secondary circuits. Flow apertures are cut in the plates in the form of narrow slots to allow the air to flow through the filters. The unit illustrated has an installed capacity of  $10 \times 1000$  cfm filter packs. The filter units are surrounded by a secondary containment in the form of a shield wall which is held at atmospheric pressure, with a filtered air inlet.

The filter packs are replaced by inserting a new filter at one end and discharging a used one into the transport flask at the other. This procedure is repeated five times to replace one bank. When the filter packs are traversing the inlet and outlet apertures the gap between the units is prevented from allowing active air to by-pass the filter by the differential pressure sucking clean air from the secondary containment both into the active and non-active sides of the filtration system.

The spent filter is discharged into a box of similar dimensions to the filter housing. This ensures that when the filter is in the box the gaskets are again isolating the active side of the filter paper. During the transition from the housing to the box an air purge is introduced at the joint between the housing and box flange to ensure the sealing faces external to the containment are not contaminated. When the filter has been pushed

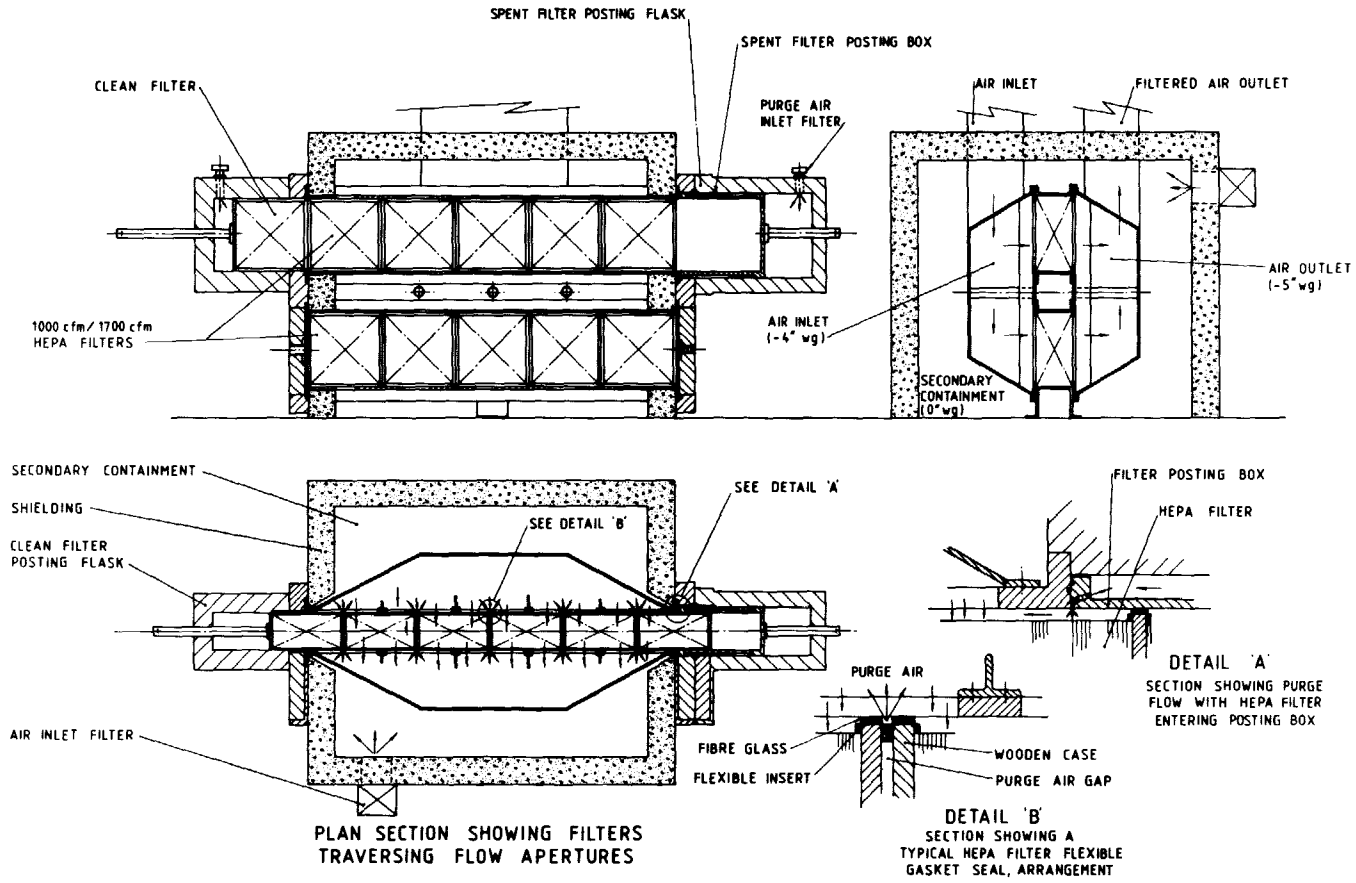

FIGURE 6  
MULTI-HEPA FILTER ARRANGEMENT WITH BAG-LESS TRANSFER



## 17th DOE NUCLEAR AIR CLEANING CONFERENCE

into the filter box the latter is withdrawn into the flask and both shield doors are closed and sealed to maintain containment. The used filter is discharged from the flask at some central waste treatment facility.

Further development is necessary on the flexible gasket seal to ensure flexibility to maintain an acceptable seal and at the same time have a frictional resistance to movement that will allow the filter packs to be moved along during replacement. The design illustrated in figure 5 shows a wooden case filter with a glass fibre cloth outer skin to the gasket seal similar to the existing high temperature seals, the cloth edges being retained by a wooden beading to form a firm fixing. If a more flexible filler than the glass-wool used at present is required possibly sponge rubber could be substituted.

### II. Circular Filter Development

#### 2.1 Introduction

An assessment of the problems associated with the installation, removal and ultimate disposal of standard deep-pleat rectangular filters has highlighted the need for alternative designs of filter inserts for remote change filter systems where high levels of alpha, beta, gamma activity can be expected. The main disadvantages of the standard filter insert result from its physical shape.

The rectangular filter is difficult to handle and position remotely, requires a high degree of flatness for the sealing face of the housing, is difficult to post into and out of a containment and produces severe problems in terms of its ultimate disposal into the standard 200 litre drum used by the UK nuclear industry.

An examination of alternative filter geometries highlighted several advantages for filters of circular geometry. These were:-

1. Circular filters would be compatible with developed double-lid posting and containment systems.
2. Circular filters would be compatible with existing waste treatment facilities and disposal routes based on 200 litre drums without breakdown or physical manipulation.
3. Circular filters could be sealed into the housings with circular pistons seal rings onto cylindrical sealing surfaces which would be easy to generate to the required tolerances and surface finishes. They could be designed such as to require no sophisticated clamping systems to effect a seal between filter and housing.
4. Circular filters would be easier to handle and move remotely.
5. Appropriate design considerations would lead to cylindrical filters significantly weaker in strength than conventional rectangular filters with subsequent ease of volume reduction by crushing prior to ultimate disposal should this be required.

Examination of current filter manufacturing technology and expertise suggested that production of radial flow cartridge filters of HEPA standard was entirely feasible at the required ratings up to 1700m<sup>3</sup>/h. Some companies had been producing high integrity filters of this type with ratings up to 200 m<sup>3</sup>/h for some time, and with the introduction of manufacturing capability for pleated panels as used in high-capacity filters no difficulties were anticipated in scaling up to 1700m<sup>3</sup>/h.

One possible disadvantage of the radial flow filter for some applications is that an air plenum is required within the housing to collect the flow after its passage through the filter prior to ducting away to extract. A much simpler, smaller and therefore cheaper housing could be envisaged if a cylindrical filter with axial flow characteristic were developed. Designs available were found to be limited to a small respirator filter approximately 100 mm diameter by 25 mm deep produced by spiral winding techniques, or to the use of a rectangular deep pleat element set into a cylindrical case.

It was therefore decided that two parallel lines of development would be followed to produce circular filters. Firstly in conjunction with the industry existing technology would be used to develop 1700 m<sup>3</sup>/h radial flow cartridge filters. Secondly the spiral winding technique would be developed to produce axial flow circular

filters in a range of sizes from 200 mm  $\phi$  to 500 mm  $\phi$ , with target rated air flows of 200 to 2000 m<sup>3</sup>/h respectively.

## 2.2 Progress to Date

**2.2.1 Radial flow cartridge filters.** This filter design has been developed in collaboration with two British manufacturers, Temperate Filtration Ltd and Machine Control Ltd. The target size for a rated flow of 1700 m<sup>3</sup>/h was 500 mm  $\phi$  by 620 mm long, compatible with the 200 litre waste drum for ease of disposal. This target has been achieved by both companies, and a prototype filter is shown in figure 7. The filters consist simply of an annulus of pleated paper supported within a perforated metal tube and sealed top and bottom, the lower end being solid. Both companies are able to produce filters with conventional metal trays and sealed with adhesives or with stiff polyurethane mouldings. In addition to the simple single annulus design Machine Control has developed an extended life version<sup>(1)</sup> incorporating a second annulus of pleated paper inside the main annulus, figure 8. Flow distribution for this filter is shown in figure 9. Performance testing of the filters has demonstrated that the life of the extended-life design, in terms of dust loading versus pressure drop, is increased significantly for both sub-micron carbon black and for BS No. 2 test dust (5 $\mu$  mean size). Results of the test programme are given in Table I.

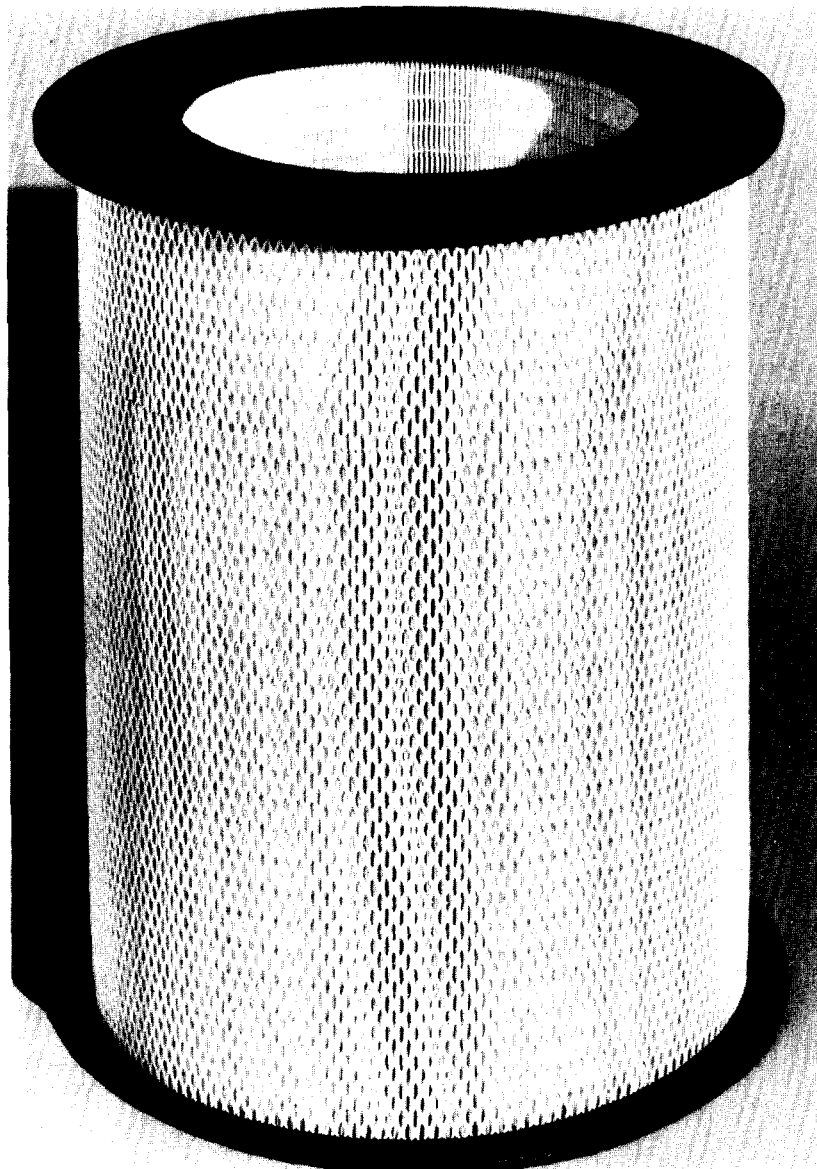

FIGURE 7  
RADIAL-FLOW CIRCULAR FILTER RATED AT 1700 m<sup>3</sup>/h

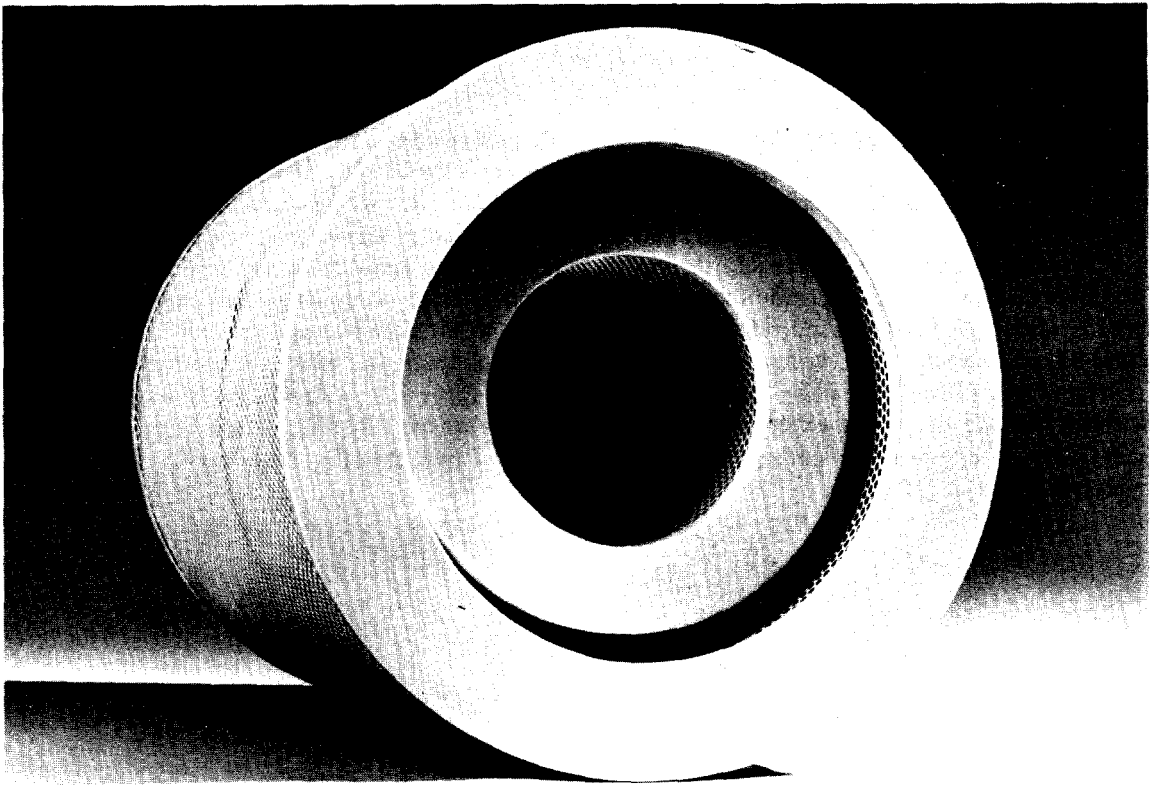

FIGURE 8  
EXTENDED LIFE RADIAL FLOW CIRCULAR FILTER RATED AT  $1700\text{ m}^3/\text{h}$

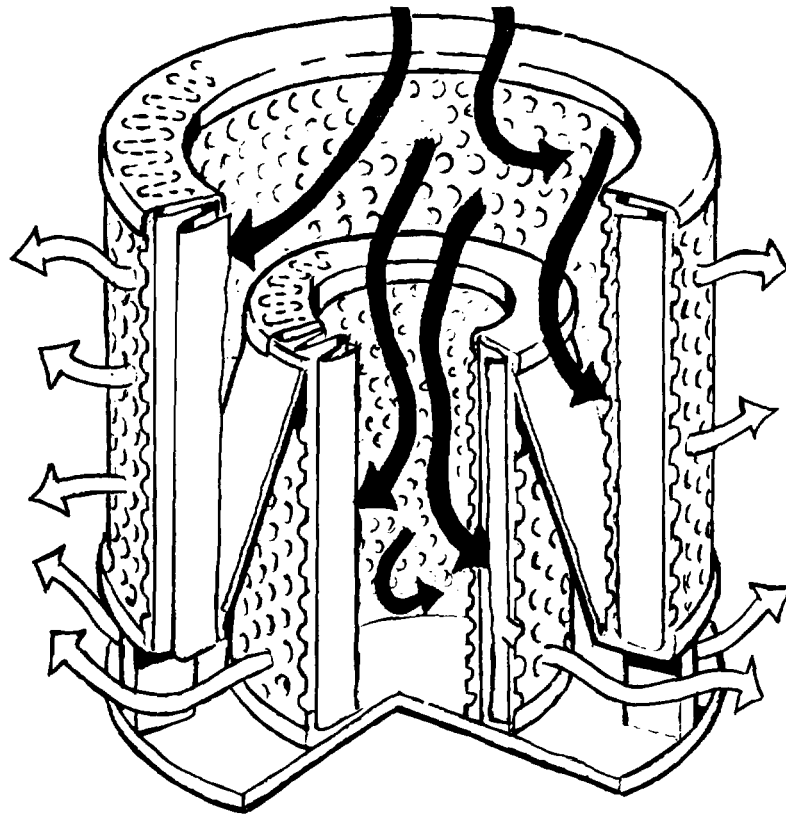

FIGURE 9  
AIR-FLOW DISTRIBUTION WITHIN AN EXTENDED-LIFE RADIAL-FLOW  
CIRCULAR FILTER

Table I. Performance of Circular Filters

<u>Parameter</u>	<u>Radial Flow Cartridge Type</u>		<u>Axial Flow Type</u>
	<u>Standard</u>	<u>Extended Life</u>	
Physical size mm	430 $\phi$ × 610	480 $\phi$ × 610	450 $\phi$ × 300
Rated Flow (m <sup>3</sup> /h)	1700	1700	800
Pressure Drop at Rated Flow (mm water gauge)	25	25	25
Efficiency (BS Sodium Flame)%	99.95	99.95	99.95
Burst Strength (mm water gauge)	300	300	300
Dust loading to 150 mm water gauge BS Nos 2 (Kg)	13	18	
Dust loading to 150 mm water gauge (Carbon block) (Kg)	0.4	0.65	0.36

Preliminary work has been carried out to assess the potential of volume reduction of the filter prior to drum disposal. It has been shown that the filter can be reduced to one quarter of its initial volume by simple compaction by a hydraulic ram within the 200 litre drum (figure 10).

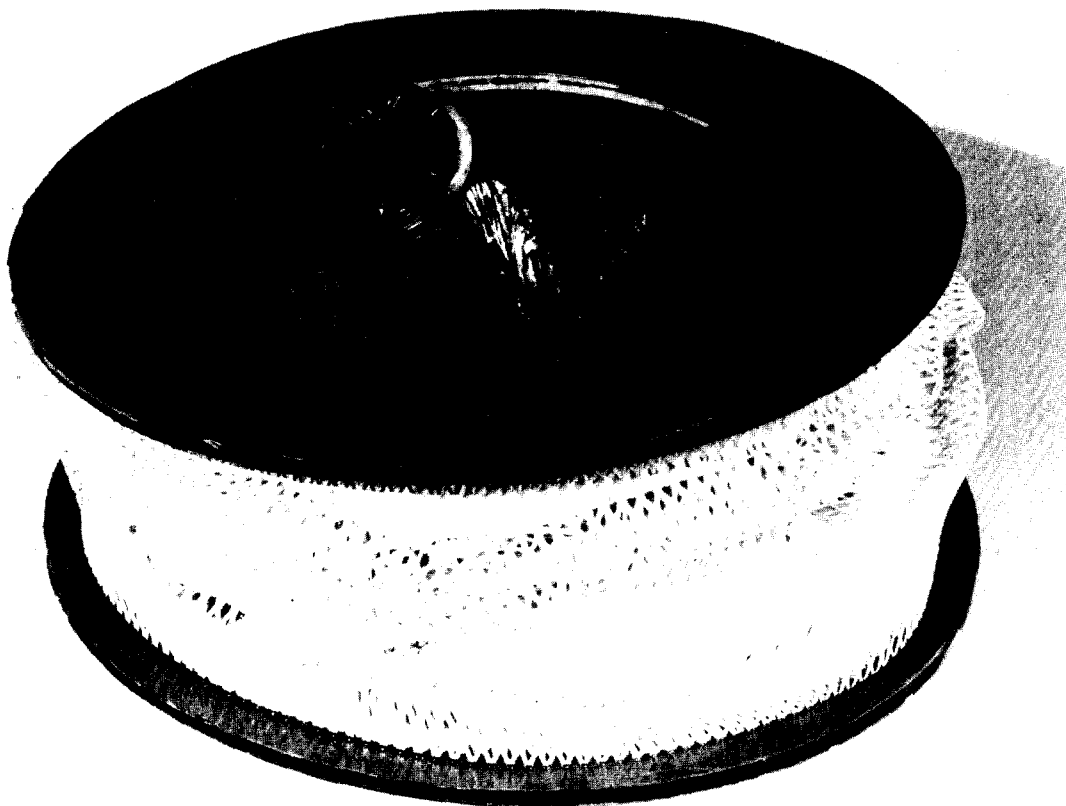

FIGURE 10 CIRCULAR FILTER CRUSHED TO 25% OF ORIGINAL VOLUME

Work is still progressing on the optimum design of gasket for this design of filter. Whilst the gasket design has to be complementary to the housing design, it is anticipated that the best solution will be the use of a "C" section ring in the inlet throat of the filter, (figure 11) enabling the filter to be sealed purely through the location of the insert in the housing, and requiring minimum dimensional tolerancing of the insert except for the inlet throat itself. No clamping would be necessary to effect a seal and the use of generous tapers on the seal spigot of the housing would simplify remote positioning.

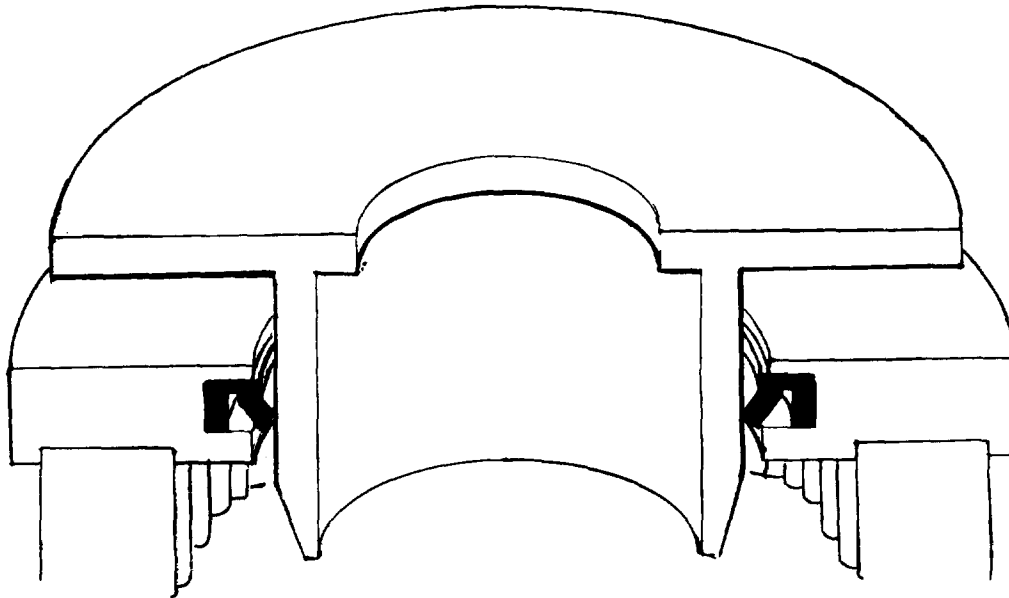

FIGURE 11  
RADIAL FLOW FILTER SEAL CONFIGURATION

**2.2.2 Axial Flow Filters.** The flow distribution and construction of the spiral wound filter is shown in figure 12. Preliminary work was aimed at scaling up the existing respirator filter to provide a 200 mm  $\phi$   $\times$  300 long filter with a target rating of 200 m<sup>3</sup>/h.

However, although from a production point of view there were few problems in producing larger prototype filters, flow tests verified the need to provide spaced flow channels in filters longer than 50 mm to reduce the pressure drop through the filter.

Filters have been produced in limited numbers for evaluation in two sizes, 200 mm  $\phi$  and 500 mm  $\phi$ , both 300 mm long (figure 13). The volumetric flow rate for a differential pressure of 25 mm water gauge is 300 m<sup>3</sup>/h and 800 m<sup>3</sup>/h for the 200 mm diameter and 500 mm diameter filters respectively. Performance data for the 500 mm diameter filter is given in Table 1.

It is anticipated that these filters when fully developed will be fitted into open ended ducts with simple 'C' section piston seals (figure 12). The installation will therefore be extremely simple and no clamping will be required to effect a seal. The strength of the filter case need be sufficient only to overcome the friction of the seals in the housing, allowing a low strength filter to be produced which would be correspondingly easy to volume-reduce by crushing prior to disposal if required.

### III. Application of Circular Filters

#### 3.1 Glove Box Filters

The first circular-bodied filters used in the UK nuclear industry were small 5 m<sup>3</sup>/h glove box filters, introduced in the mid sixties. The filter element was a hand-folded radial-pleated glass fibre paper element

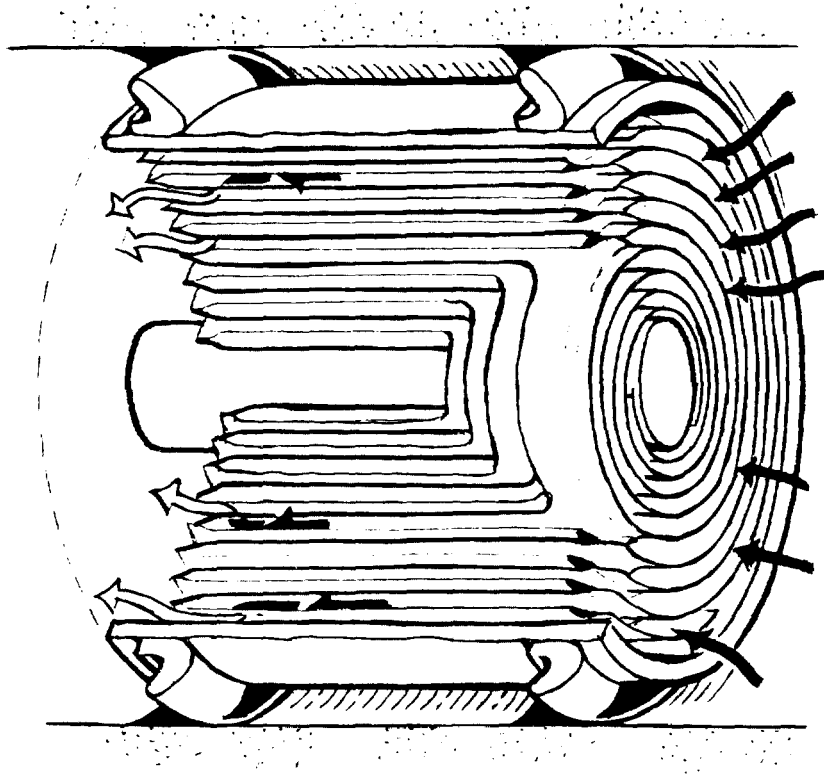

FIGURE 12  
AIR-FLOW DISTRIBUTION WITHIN AN AXIAL-FLOW CIRCULAR

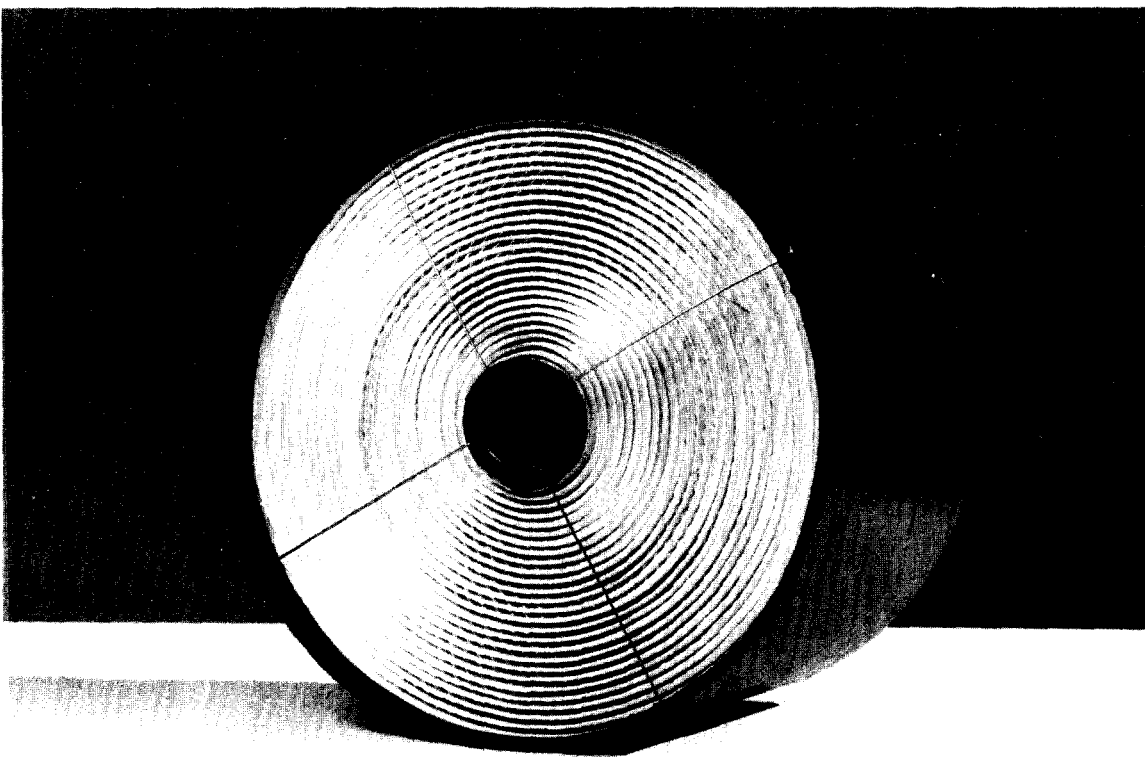

FIGURE 13  
PROTOTYPE AXIAL-FLOW CIRCULAR FILTER

sealed into moulded housings to provide an axial flow through the unit. Recently the filter element has been redesigned and is now constructed from an annulus of machine pleated glass-fibre paper sealed into the same mouldings. The use of machine pleated paper has enabled a greater area of paper to be used with the result that the filter is uprated to  $20 \text{ m}^3/\text{h}$ . The efficiency and pressure drop at rated flow is unchanged at 99.998% and 10 mm water gauge respectively.

### 3.2 High-level Active Cell Primary Filters

The primary extract filters for a suite of high activity cells were designed to fit in a well under the cell floor.

The filters specified are 2 standard deep-pleat filters measuring  $380 \times 380 \text{ mm} \times 220 \text{ mm}$  rated at  $400 \text{ m}^3/\text{h}$  and rely on their weight and generated pressure drop to effect a seal onto a feature in the well by conventional gaskets. Operating experience has revealed that on two cells of the suite activity levels on the primary filters were such that posting and transfer for ultimate disposal was restricted to the use of standard  $7'' \phi$  containers within a shielded flask. Thus it has been necessary to dismantle the filters remotely within the cell after a filter change into pieces small enough to be accommodated within the  $7'' \phi$  containers.

The primary filters are now being replaced with a cluster of 10 radial flow cartridge filters, (figure 14) measuring  $165 \text{ mm } \phi \times 200 \text{ mm}$  long rated at  $85 \text{ m}^3/\text{h}$  each. The filters are sealed into a plate sealed into holes in a metal plate by piston 'O' ring seals fitted in the top flange of each filter. The plate is sealed onto a feature of the well using conventional gaskets which provides a lower plenum for the filtered air and space for the filter bodies. Thus a seal is effected which requires no clamping, and which enables the filter to be changed easily using cell master-slave manipulators. Disposal is directly into the container with no dismantling being necessary.

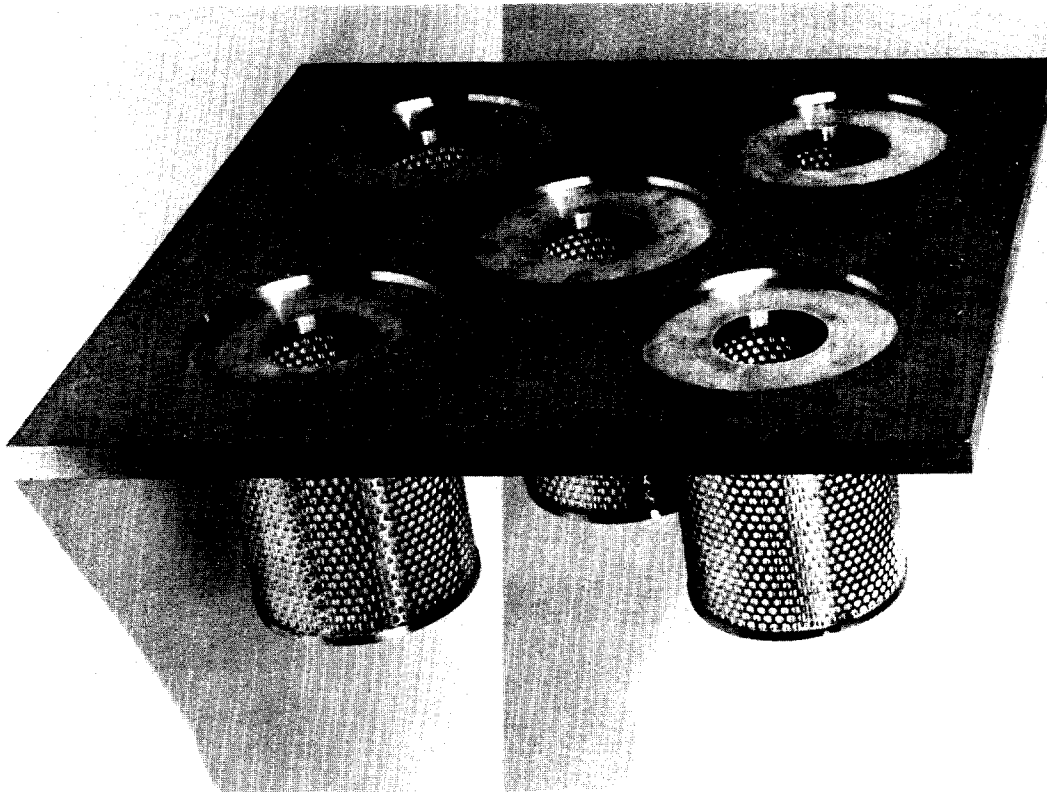

FIGURE 14  
CLUSTER OF RADIAL-FLOW FILTERS FOR ACTIVE CELL PRIMARY FILTER INSTALLATION

The new design overcomes the basic sealing and remote handling problems associated with rectangular deep pleat filters and removes the requirement for costly in cell operations in preparation for disposal.

### 3.3 Push Through Change System for Active Cell Primary Filters

Design work on a new active cell facility for radiation chemistry studies particularly on reactor fuel pins was began in 1979, with a commissioning target date of 1984. The facility has been fully described elsewhere<sup>(2) (3)</sup>.

The cell primary filtration was specified as a remote change system rated at 250 m<sup>3</sup>/h. The physical constraints for the filter system were that the housing should project no more than 500 mm from the rear wall of the inner box, and filter insert itself should be small enough to be posted from the box via the installed posting system, which limited the size of the element to 210 mm  $\phi$  diameter by 400 mm long.

The derived scheme for the system is shown diagrammatically in figure 15.

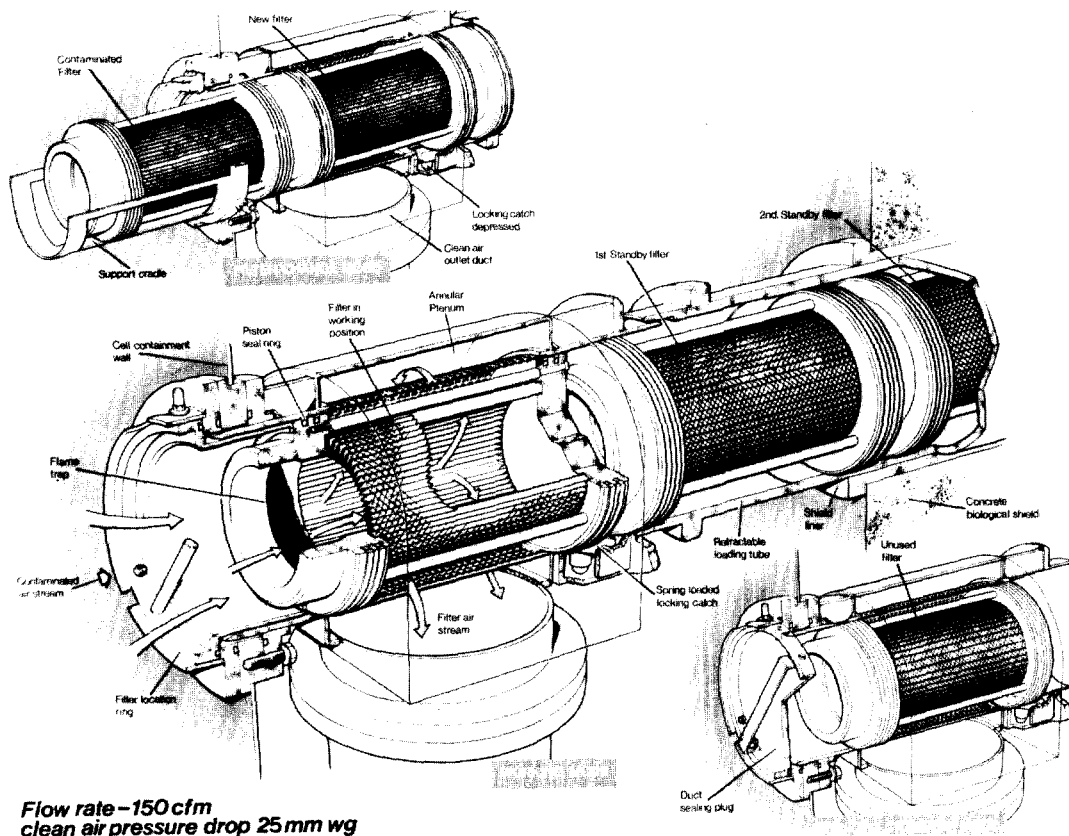

FIGURE 15  
PUSH-THROUGH FILTER CHANGE SYSTEM

The filter insert is of radial flow cartridge design. An annulus of pleated paper is supported inside a perforated steel tube between end flanges, each carrying a piston ring seal. The seals currently employed are of rectangular-section, glass-fibre reinforced PTFE, supported on an 'O' ring to provide the required resilience. The use of PTFE gives a low friction seal as well as providing good resistance from chemical attack by acid vapours in the extract air. In addition the square edge of the seal will remove debris deposited in the throat of the housing during the filter ring change and provide a clean surface for the replacement filter seal.

The performance of the filter has been determined as 250 m<sup>3</sup>/h at 25 mm water gauge with an installed efficiency of 99.97%; BS.3928 : 1967 Sodium Flame.



## 17th DOE NUCLEAR AIR CLEANING CONFERENCE

The housing is constructed from stainless steel. An annular plenum chamber collects filtered air which is then carried away to extract. One feature of note is the provision of spring latches to prevent displacement of the element in the event of a pressure excursion in the cell. Tests on seal performance and friction forces revealed that the optimum surface finish for the sealing surfaces was a good machine finish of  $1.6\mu\text{m}$ . No advantages could be obtained from ground or honed finishes.

Stand-by filters are carried in a loading tube which mates up with the filter housing and penetrates the concrete biological shielding. The end of the tube carries a push rod system and solid steel shield plug. The loading tube is withdrawable to allow the inner box and housing to be removed for decommissioning and refurbishing. The filter is changed by operating the push rod against the end of the stack of stand-by filters on a fixed stroke. The used filter is ejected into the box as the new filter is positioned. During the filter change operation the air extract could be shut off, which could allow a small pressure rise to occur in the box. Alternatively the extract system could be left on to prevent a rise in box pressure, but allowing unfiltered air to be drawn from the box past the filter into the duct. However, no serious contamination spread is predicted as the filter change time is short and filters downstream of the box extract duct would prevent release of activity to the environment.

The principle advantages of this system are that the contaminated filters require no special handling and are dealt with through the same route as other arisings; the change system is very simple and no filter clamping is required.

### 3.4 Remote Shielded Filter Change System for Alpha, Beta, Gamma Contaminated Gas Streams

In 1978 a requirement was identified for a remote, shielded change system for Iodine 129 Absorber beds for the off-gases from a BNFL fuel reprocessing facility.

The initial design study suggested that the AC6120 absorber material be contained in stainless steel drums similar in size to the standard 200 litre drum. Double-lid technology is used to combine the function of duct damper and drum port closure. Both inlet and outlet drum ports are in the top face of the drum together with location features for the drum both in the flask and on a transfer trolley within the facility thereby ensuring that close tolerance features would be contained in the drum top plate.

A modular design for the facility was chosen, each module containing its own gamma-gated load/unload facility and transfer trolley to move the canister across the facility to the working position. The gas ductwork runs across the top of the modules, with the drum connected from below the ductwork by raising the drum on a tilting mechanism built into the transfer trolley.

The double lid operating mechanism, a developed version of the standard Drath-Schrader system is mounted on the top shielding plate of the facility. A central shaft penetrates the shielding and gas duct and carries the inner lid assembly. The port features are incorporated in a removable insert in the bottom of the duct. Co-axially inside the shaft is the rod mechanism which operates over-centre claws to interlock the lids. Both lids are then withdrawn into the duct clear of the port to allow gas flow into and from the drum.

Shielding of the facility is accomplished by the use of 100 mm steel plate for construction of the outer shell of the facility, although the provision of extra shielding would not affect the design principles.

The design of the facility is shown pictorially in figure 16.

A prototype cell has been constructed and full testing and evaluation is now proceeding. The essential features of the design are shown in figures 17 - 20.

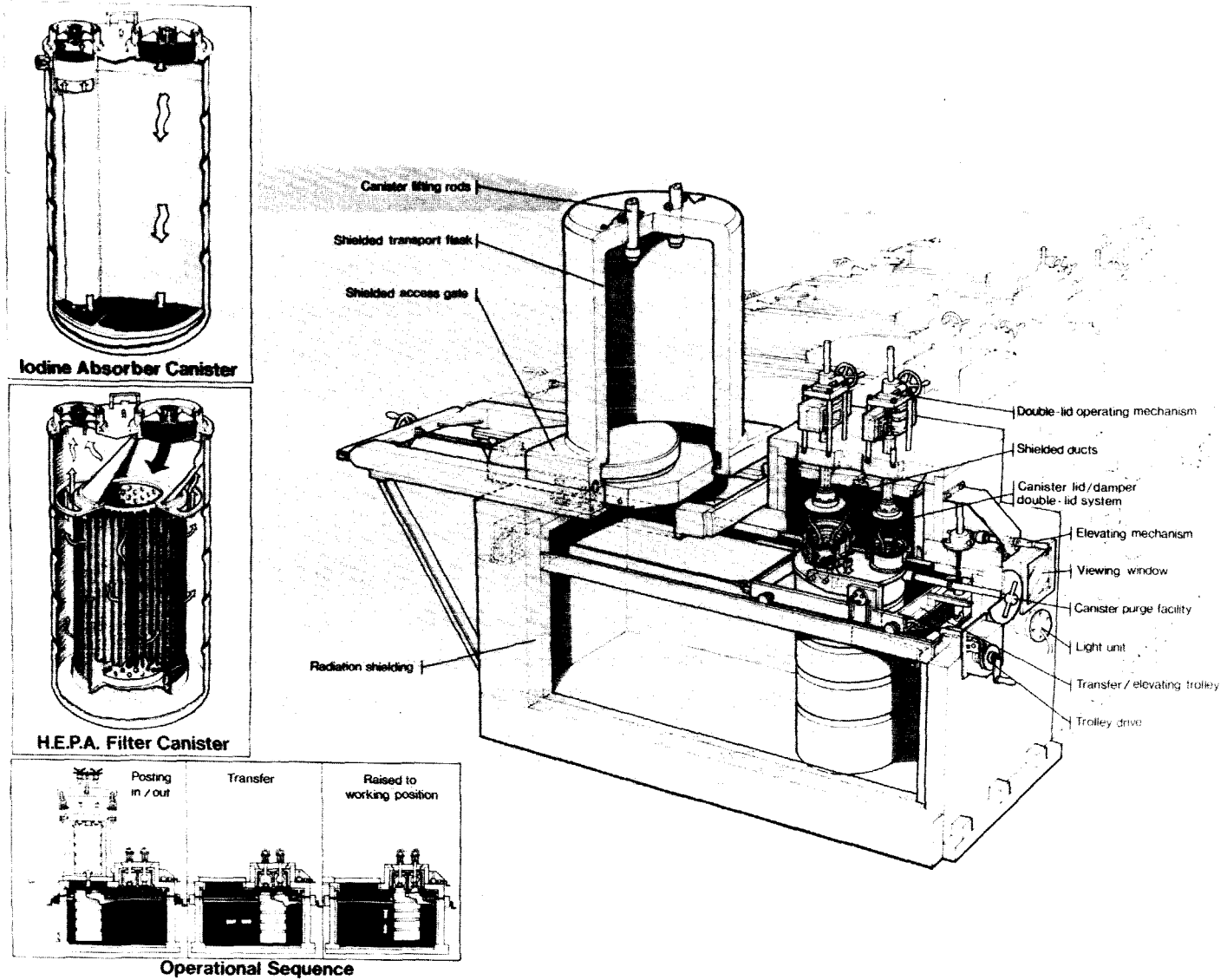

497

FIGURE 16  
REMOTE SHIELDED CHANGE SYSTEM FOR FILTER CANISTERS



FIGURE 17

REMOTE SHIELDED CHANGE SYSTEM SHOWING CELL CONSTRUCTION



FIGURE 18

REMOTE SHIELDED CHANGE SYSTEM SHOWING DRUM ON  
TRANSFER TROLLEY

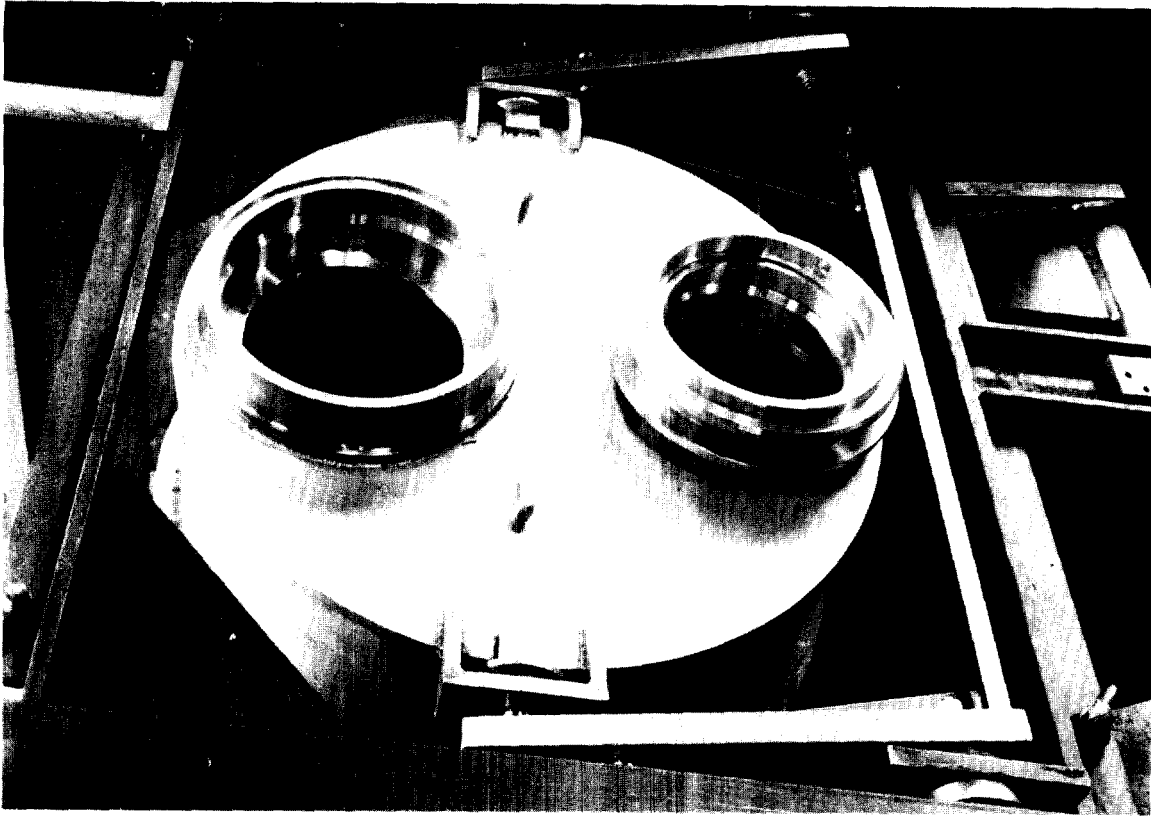

FIGURE 19  
REMOTE SHIELDED CHANGE SYSTEM SHOWING DETAILS OF DRUM TOP PLATE ASSEMBLY

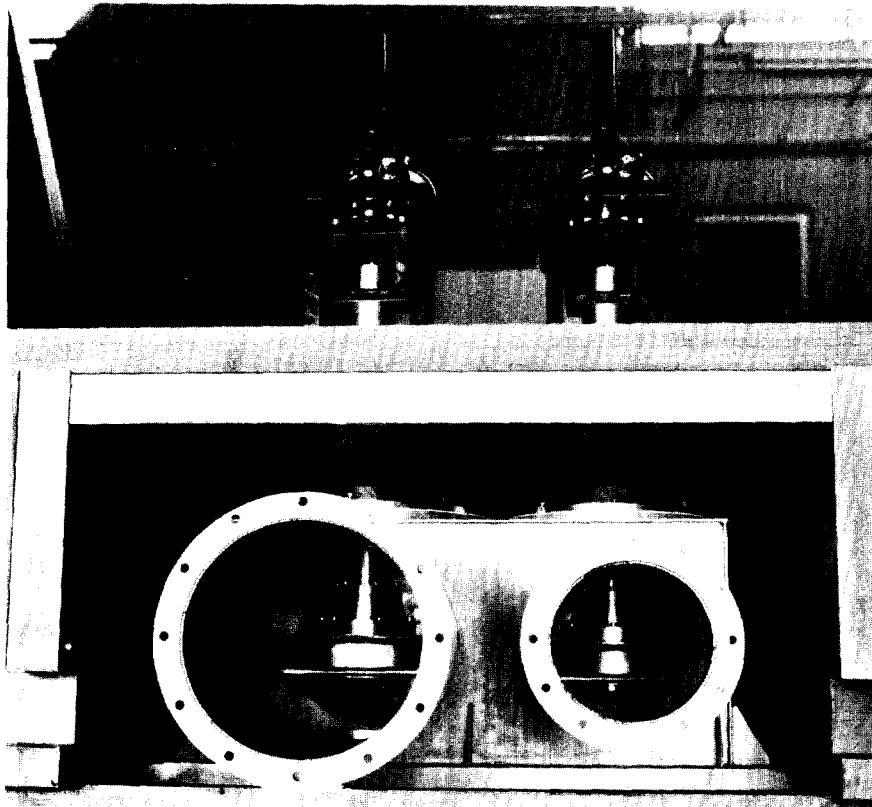

FIGURE 20  
REMOTE SHIELDED CHANGE SYSTEM SHOWING DOUBLE-LIDS RAISED INTO DUCTS

## 17th DOE NUCLEAR AIR CLEANING CONFERENCE

During the design stage of the work, it became apparent that through the use of a demountable drum and circular cartridge filters the facility design could be extended to provide a shielded remote filter change facility for alpha, beta, gamma gas streams. One possible drum design is shown in figure 21. The top section of the drum is modified to provide co-axial gas ducts for the inlet and exhaust gases. The filter is sealed into the top section with a "C" section throat seal. The bottom of the drum is demountable with a double-lid feature to enable the filter insert to be changed in an appropriate facility. Alternatively the drum could be split in the plane of the filter seal if preferred.

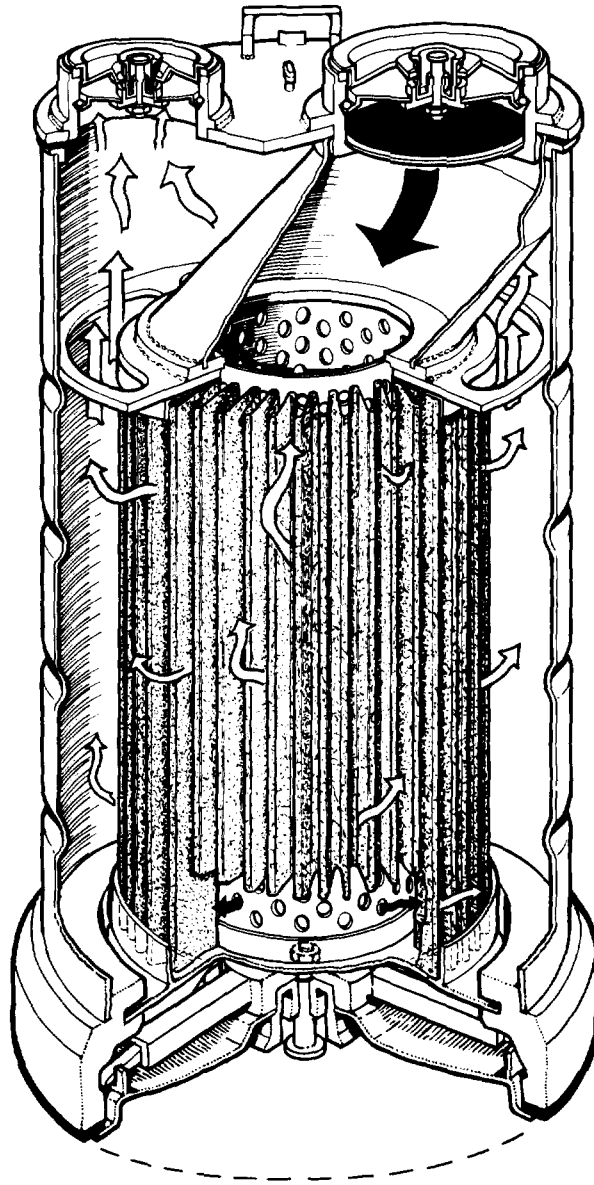

FIGURE 21  
DEMOUNTABLE HEPA FILTER DRUM

The operating features of the facility are such that no problems are likely to be encountered should it be necessary to provide greater thicknesses of shielding. Thus the design is adaptable for any plant which requires remote filter change facilities and the transfer of sealed filters.

The additional advantage in the use of filters in canisters is that leak tests can be carried out prior to posting the drum into the facility thereby eliminating the problems of filter-to-housing gasket leaks normally encountered with remote change systems.

3.5 Application of Circular Filters for large Volume Installations

Because of the relative ease of sealing without clamping and ease of disposal, the use of circular filters for large volume facilities should be of benefit compared to the use of conventional rectangular filters. The principles outlined in Section 2.2 can easily be applied to 1700 m<sup>3</sup>/h filters to provide a low volume installation for high air throughputs.

The use of a double lid system to seal the filter combined with the manifold system could provide the basis for an alternative system to bag changing. A typical installation is shown in figure 22.

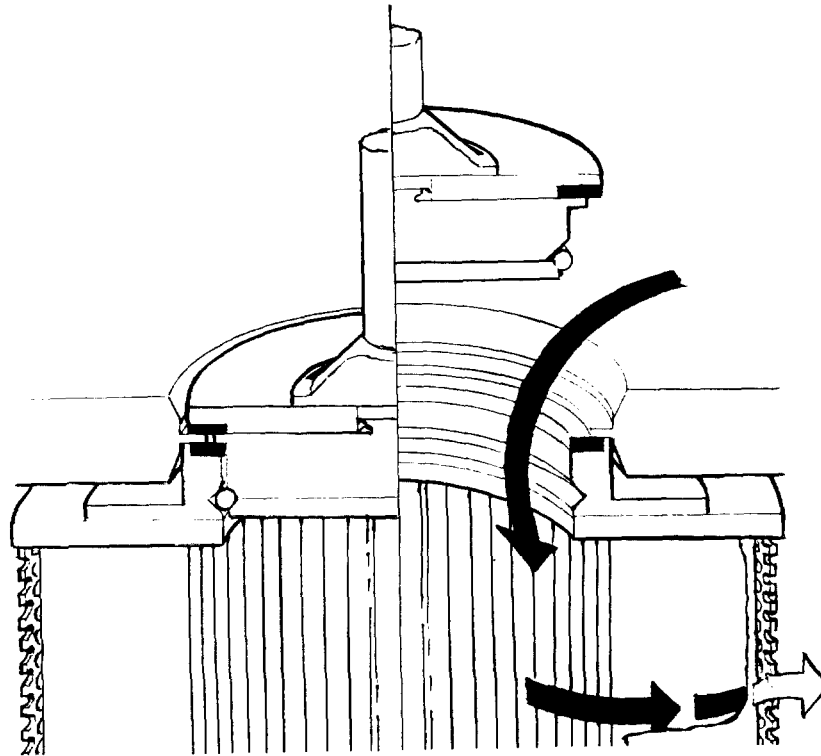

FIGURE 22  
RADIAL-FLOW FILTER WITH DOUBLE-LID CONNECTION FOR ALPHA-CONTAMINATED FACILITIES

The filter top flange would carry a double lid feature to carry one lid over the inlet port. The filter would be raised up to engage in the port facility mounted in the plate separating inlet and extract plenums. The double lid mechanism would be mounted in the top of the inlet plenum and the inner lid act as a flow damper as in the remote change facility described in Section 3.4.

Engagement of the lids and withdrawal would bring the filter on stream and reversal would seal the filter prior to removal. The filter body and double lid would provide a sealed containment for any alpha activity within the filter.

IV. Conclusions

In all aspects of active handling the volume of waste generated is progressively being reduced or is being treated to arrive at the minimum volume of package. It is essential that filters which will soon be the largest single item of waste follows this pattern by the elimination of the waste bagging material and the reduction in volume of the filter pack itself. In order that this may be achieved more engineered methods of handling such as those described will be necessary.

The adoption of a secondary containment removes from the gasket seal the arduous task of sealing to the same standard on the filter paper itself. This change should result in much simpler and more efficient filter

housings.

The development and test work carried out to date has demonstrated that high integrity filters of equal performance to conventional deep-pleat designs can be produced in radial flow cartridge form in sizes up to 1700 m<sup>3</sup>/h. The application of these filters to nuclear off-gas cleaning facilities should provide better systems in terms of filter seal performance, reduced handling problems and ease of disposal of contaminated filters via existing disposal routes. Filter systems incorporating these filters are being developed for high contamination level applications, whilst their use for low contamination applications is being studied.

The development of axial flow filters should provide a filter insert which requires a simpler housing design where the use of piston seals combined with axial flow characteristics will lead to extremely simple installations.

It is unlikely that circular filters of either design will replace conventional filters where ladder or wall mounted systems provide acceptable filtration installations, but the study of their application for all other applications is recommended and should prove beneficial in terms of quality of installation, ease of handling and ultimate disposal of used filters.

#### Acknowledgements

The authors wish to record that some of the work described above has been funded by British Nuclear Fuels Ltd.

They would also like to record their thanks to Temperate Filtration Ltd, and Machine Control Ltd for their help and assistance in developing the radial-flow cartridge filters and Filtrel Ltd for their assistance in developing the spiral wound filter described in this paper.

#### References

1. British Patent Application published June 1980; U.S. Pat. Pending
2. Brown, P. E. et al "A new chemical alpha, beta, gamma active handling facility: conceptual aspects." Trans.Am.Nuclear Soc., 38.706 (1981)
3. Campbell, D., Ritchie, A. B. "A new chemical alpha, beta, gamma active handling facility: engineering aspects" Trans.Am.Nuclear Soc. 38.708 (1981)

DISCUSSION

GERBER: How is the spiral-wound axial flow filter constructed so as to properly form the entry and exit flow channels?

PRATT: A spacer of the same form as used on conventional filters is inserted continuously between the layers of filter media during winding. This ensures that the correct size of flow channel is maintained. The sealing of the end of each flow channel to achieve required efficiency is either by use of a thick bead of adhesive of the same height as the flow channel spacer or the media are locally crimped together with contact adhesive used to effect a seal (see fig. 12 of paper.)

GERBER: How do you measure the integrity of your system?

PRATT: We do bench testing using sodium flame photometry. We test the filter in a model housing to check the installed efficiency of the seal.

HERMAN: How is the integrity of the filter verified considering the effect of the sealant?

PRATT: By pressure drop comparison. The integrity of the filter is not affected by gasket leaks as the differential pressures between the secondary containment and inlet and extract ducts does not allow by-passing of contaminated air. Calculations indicate that a 0.02" gap between the filter gasket and frame will result in a net inflow of air from the secondary containment of only approximately 1½ % of the rated flow of the filter. Therefore, integrity of the filter can be measured by normal in situ DOP test techniques. The particular system described has the added advantage that individual units can be isolated for integrity testing.

HACKNEY: I would comment further that the integrity of the gasket seal is measured by checking the flow into the secondary containment and measuring the pressure differential between the secondary containment and the atmosphere. Any flow measured will signal a flow through the gasket seal. This is not hazardous as the unfiltered air cannot by-pass the filter paper.



# 17th DOE NUCLEAR AIR CLEANING CONFERENCE

## AEROSOL FILTRATION WITH METALLIC FIBROUS FILTERS

M. Klein, W.R.A. Goossens  
S.C.K./C.E.N. Nuclear Energy Center  
200 Boeretang  
B-2400 MOL, Belgium

Contract WAS-228-81-8B(RS) with the  
Commission of the European Community

### Abstract

The filtration efficiency of stainless steel fibrous filters (BEKIPOR porous mats and sintered webs) is determined using sub-micronic monodisperse polystyrene aerosols. Lasers spectrometers are used for the aerosol measurements. The parameters varied are the fibre diameter, the number of layers, the aerosol diameter and the superficial velocity. Two selected types of filters are tested with polydisperse methylene blue aerosols to determine the effect of bed loading on the filter performance and to test washing techniques for the regeneration of the filter.

### I. Introduction

In many nuclear process plants, the filtration of aerosols in process streams is generally performed by various purification systems put in line. The final system always consists of high efficiency HEPA filters arranged in series and in parallel ; a characteristic of these HEPA filters is their high DF and their low dust loading capacities in relation to the low pressure drop they can withstand. The aim of this study is the development of prefilters with high dust loading capacities and which could be in-situ regenerated in order to extend their operational life time. They should retain most of the aerosol charge of the gaseous effluent, should withstand the nature of the process stream ( $\text{NO}_x$  in the case of reprocessing streams or HLLW calcination streams) and should support the stream temperature in the case of high temperature processes (Incineration or vitrification processes).

Various types of prefilters can meet these requirements, among them the sintered metal filters, the glass fiber filters and the metallic fiber filters. The latter type has been chosen in this study. The experimental study has been concentrated on two types of filters (high porosity mats and sintered webs) purchased by a Belgian company BEKAERT N.V.

### 2. Description of BEKINOX filtration materials

BEKINOX is the trade mark of minute fibres made of various alloys and metals such as : - Inconel 601  
- Titanium, Nickel.

The fibres are available in different forms such as staple and bulk fibres or yarns and in different diameters ranging from 4 to 22  $\mu\text{m}$ . The high porosity mat type with its trade name BEKIPOR WB is

a stainless steel porous medium with high porosity. The main characteristics of the different types of mats tested are given in table I.

Table I. Characteristics of BEKIPOR WB mats

Type	Diameter of the fibre $\mu\text{m}$	Superficial weight $\text{g}/\text{m}^2$	Porosity of the web %	Thickness of the web cm
04/300	4	300	0.99	0.35
08/300	8	300	0.99	0.35
12/300	12	300	0.99	0.35

The second type tested is a sintered web with trade name BEKIPOR ST. It is a depth type stainless steel filter medium composed of very fine stainless fibres randomly laid into a 3 dimensional labyrinth structure. This mat is further compacted and sintered to produce a filter of high mechanical strength but of lower porosity. The AL series have high dust holding capacities and can be used either for liquid filtration of high viscosity fluids, either for gas filtration. The main characteristics, of the 3 types BEKIPOR ST/AL tested, are given in table II.

Table II. Characteristics of BEKIPOR ST sintered webs

BEKIPOR ST	10AL2	252L2	401L2
Absolute filter rating for liquid filtration $\mu\text{m}$	10	25	40
Superficial weight $\text{g}/\text{m}^2$	530	1100	1100
Porosity %	80	75	80
Thickness H cm	0.033	0.055	0.065

### 3. Theoretical considerations on aerosol filtration with fibrous material

Theory predicts the collection efficiency by diffusion to decline as fiber size  $d_f$ , gas superficial velocity  $u$ , and bed porosity  $\epsilon$  increase. For a deep filter, such as the bekipor WB, diffusion plays an important role for the particles smaller than  $0.5 \mu\text{m}$  and the efficiency must increase with smaller fibre diameter and decreasing superficial velocity. For a thin, low porosity filter, such as the Bekipor ST, the role of diffusion will be less important because the residence time of the particle in the filter is one order of magnitude smaller than for a deep filter.

The collection efficiency by interception can be shown to be a function of the direct interception parameter  $R = d_p/d_f$ . The direct interception parameter increases with increasing particle size  $d_p$  and decreasing fibre diameter  $d_f$ . It becomes to play an important role for the particles greater than  $0.3 \mu\text{m}$  for the finest fibre diameter i.e. for  $d_f = 4 \mu\text{m}$ .

The collection efficiency by impaction depends mainly on the parameter  $I = m.u.B/d_f$  which represents the ratio of the stopping distance of a particle (product of mobility  $B$  and momentum  $m.u.$ ) to the dimension of the fibre  $d_f$ . The efficiency of impaction increases with the particle mass  $m$  and the velocity of the gas and decreases with increasing fibre diameter. This capture mechanism plays an important role only at high superficial velocities and for particles greater than  $1 \mu\text{m}$ .

Generally all the three mechanisms play a role in the filtration of aerosols by fibre filters. The influence of  $d_p$ ,  $d_f$ , and  $u$  on the efficiency of the different capture mechanisms can qualitatively be given as follows

	$d_f \uparrow$	$d_p \uparrow$	$u \uparrow$
Diffusion	↓	↓	↓
Interception	↓	↑	-
Impaction	↓	↑	↑

#### 4. Description of the experimental procedure

The flow sheet of the test unit is given in Fig. 1. The main parts of the unit are ; a Collison atomizer as aerosol generator, a dilution system, a filter holder and an aerosol measuring system. The flow ranges in the different parts are given in Fig. 2. It illustrates that the dilution system allows to perform tests in a superficial velocity range of 3.5 to 19 cm/s with flat filters of an useful diameter of 15 cm. The filter holder accepts up to 15 layers of flat filters in series. The characteristics of the spectrometers ASAS-X and CSAS are given in table III. These apparatus which operate on the principle of light scattering by a particle illuminated in a laser beam, produce a signal which depends on the size, shape and refraction index of the particle.

The same experimental procedure was used for all tests ; a diluted water solution of polystyrene monodisperse particles is sprayed using the Collison atomizer. The water spray, containing the latex aerosols is diluted and dried with clean air. The aerosol particle flow (Part/s) is alternatively measured before and after the filter with the two lasers spectrometers using the proper size range channels. Three measurements are made before the filter and two after the filter. A mean value of the particle flow before and after the filter is determined for each monodisperse aerosol. The mean decontamination factor,  $DF$ , is calculated on the basis of one set of flow values for the range 0.092 to 0.33  $\mu\text{m}$  where only the ASAS can be used and on the basis of two sets of values for the range 0.33 to 2.2  $\mu\text{m}$  where both spectrometers can be used. During each filtration run, also the pressure drop  $DP$  over the filter material is followed.

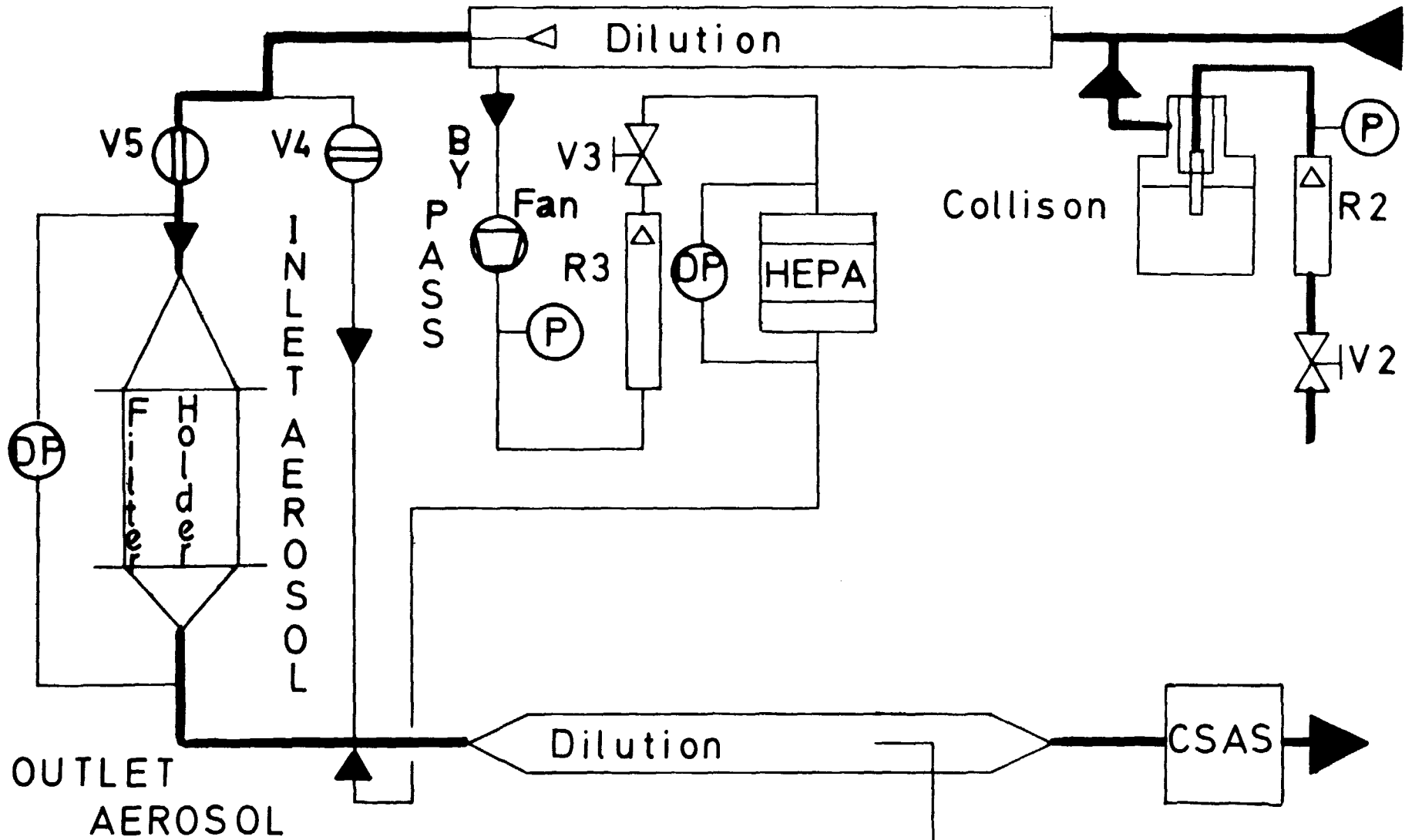

Fig1. TEST UNIT FOR AEROSOL  
FILTRATION AT LOW TEMPERATURE

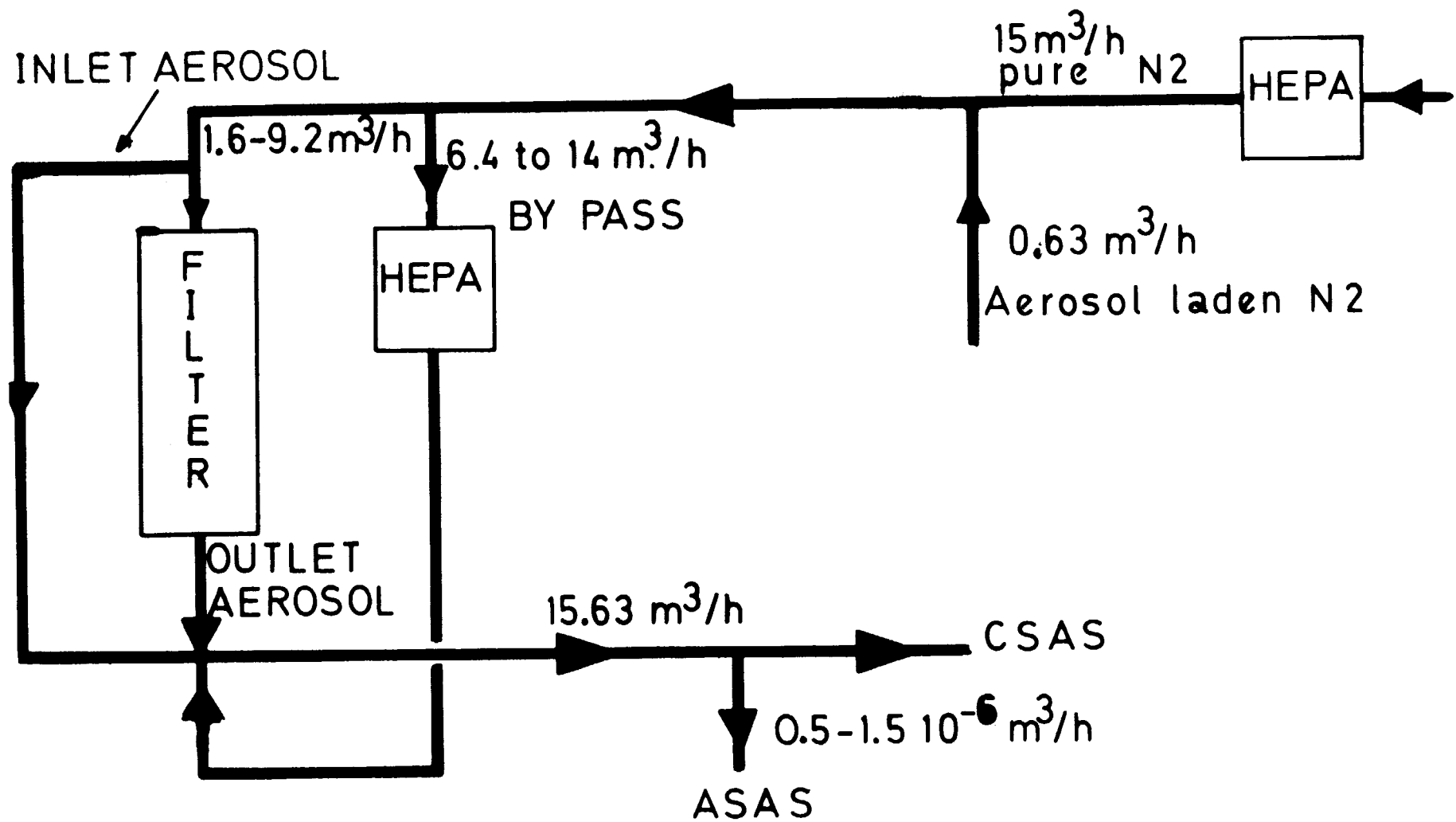

Fig2.FLOW SHEET OF A.F.L.T.

17th DOE NUCLEAR AIR CLEANING CONFERENCE

Table III. Characteristics of lasers spectrometer

	ASAS-X	CSAS-100 HTS
Size range	0.60 - 3.00 $\mu\text{m}$ 0.24 - 0.85 $\mu\text{m}$ 0.15 - 0.30 $\mu\text{m}$ 0.090 - 0.195 $\mu\text{m}$ in 15 channels	0.32 - 0.755 $\mu\text{m}$ 0.5 - 2.75 $\mu\text{m}$ 1.0 - 12.25 $\mu\text{m}$ 2.0 - 20.0 $\mu\text{m}$ in 15 channels
Working temper.	25 °C	max 370 °C
Sample gas flow	0.5 - 1.5 cc/s	15 - 20 m <sup>3</sup> /h
Sheat gas flow	20 cc/s	-
Sample volume	Hydrodynamically focused jet 70 $\mu\text{m}$	Optically defined volume 150 $\mu\text{m}$
Collecting solid angle	-35 - 120 °C (> 2 $\pi$ stérad)	-
Laser	He-Ne 2 mw 6328 Å TEM $\infty$ mode	He-Ne 5 mw 6328 Å High order random mode
Energy density	500 W cm <sup>-2</sup>	30 W cm <sup>-2</sup>

5. The parametric study of the BEKIPOR WB porous mats

During the experimental investigation of the porous mats, the different parameters were varied as follows :

- nature of the web : 04, 08, 12
- number of layers n : 1, 3, 5
- superficial velocity u : 3.5, 10, 13, 19 cm/s
- particle diameter d<sub>p</sub> : 0.091, 0.109, 0.173, 0.220  
0.330, 0.481, 0.620, 0.720  
0.945, 2.20  $\mu\text{m}$ .

During all the runs, the pressure drop over the filter remained equal to the value measured before the run with clean air. It means that the loading with latex aerosols at concentrations lower than 0.5 mg/m<sup>3</sup> had no influence on the bed porosity during the short time of a run. Also the DF remained constant during a run.

Qualitative observations on the influence of the tested parameters on the values of the DF and the DP are given hereafter.

	d <sub>f</sub> ↓	u ↓	n ↑	d <sub>p</sub> ↑
DF	↑	↑	↑	↘ ↑
DP	↑	↓	↑	→

The most important results obtained are shown in Fig. 3, 4 and 5. Vertical lines around a data point indicate the uncertainty range of the particular data point.

As illustrated in Fig. 3 and 5, a minimum of DF is observed in the size range 0.11 to 0.173  $\mu\text{m}$  due to the well known decrease of the diffusion mechanism and to the increase of the interception mechanism

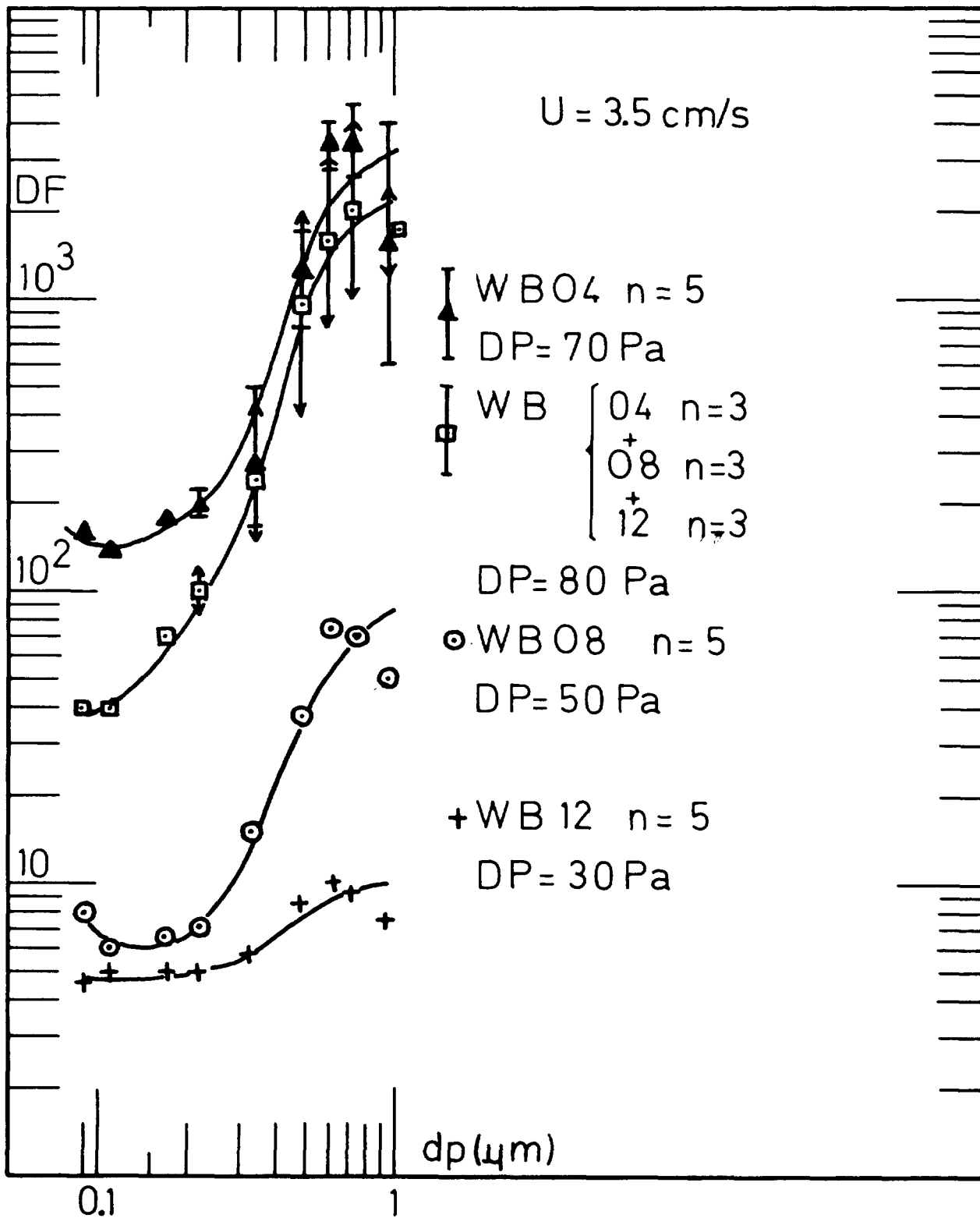

Fig. 3. Influence of filter material and configuration

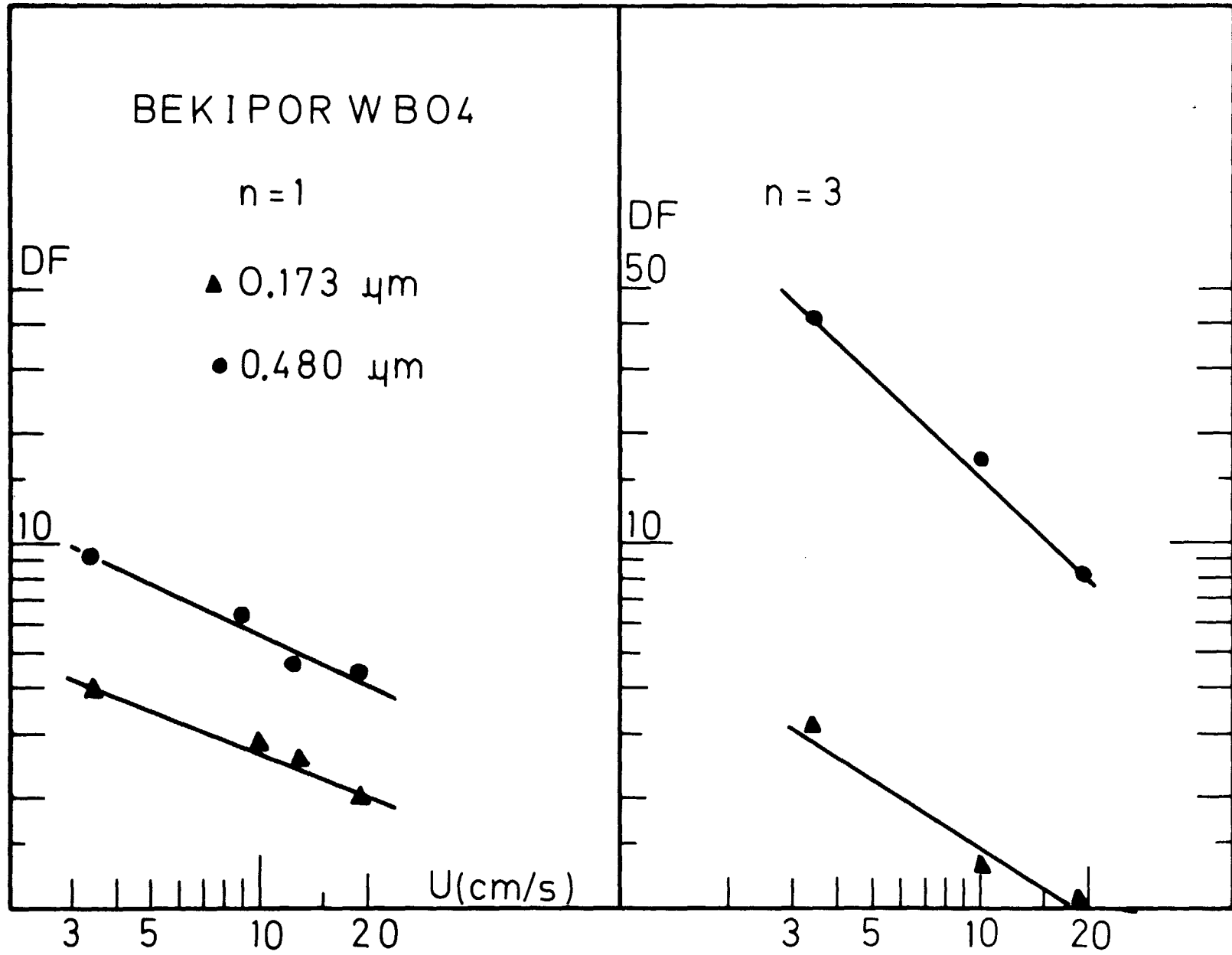

Fig. 4. Influence of superficial velocity



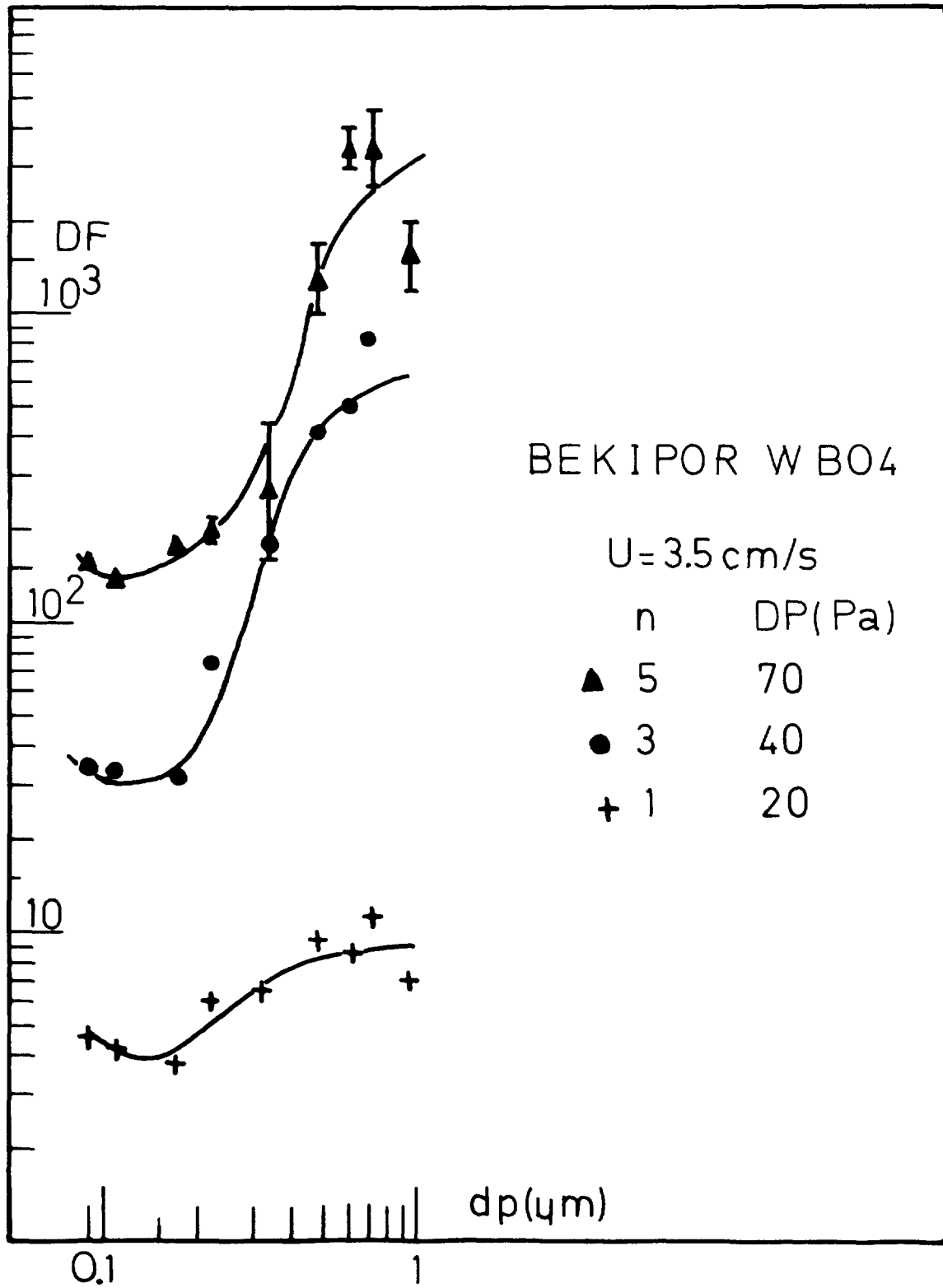

Fig. 5. Influence of number of layers

as a function of aerosol size.

- The main practical informations drawn from these tests are :
- the webs 08 and 12 show very low DF and DP unless the number of layers is high ;
  - the web 04 is the most effective when the superficial velocity is lower than 5 cm/s and when the number of layers is high i.e. for  $n = 5$ . In these conditions, the DF is higher than 100 for a  $0.1 \mu\text{m}$  aerosol and higher than 1000 for a  $1 \mu\text{m}$  aerosol ; the pressure drop remaining at a reasonable value of 70 Pa ;
  - an alternative to this optimum situation, is to use the three webs in series with the coarser layer WB12 first followed by the WBO8 and finally the WB04 as last layer. With such a set of layers it is also possible to reach satisfactorily results (DF of 40 for the  $0.1 \mu\text{m}$  and 1000 for the  $1 \mu\text{m}$ ) with low pressure drop (DP = 80 Pa). The advantage of the use of decreasing fibre diameters in series, is, that in case of high dust loadings, the pressure drop evolution is not so steep and the dust holding capacity is higher.

#### 6. The parametric study of the BEKIPOR sintered webs

- The parameters were varied as follows :
- nature of the mat : 10AL2, 25AL2, 40AL2
  - superficial velocity  $u$  : 3.5, 6, 19 cm/s
  - particle diameter  $d_p$  : 0.091 to  $2.2 \mu\text{m}$ .

The DF and DP of the different runs are given in fig. 6. Qualitative observations on the influence of the tested parameters on the values of the DF and the DP are given hereafter.

	$d_f \uparrow$	$u \uparrow$	$d_p \uparrow$	$t \uparrow$
DF	↓	↓	↑	↑
DP	↓	↑	↑	↑

For the runs at low superficial velocity, no significant increase of pressure drop is measured for the three kinds of mats. At high superficial velocity (19 cm/s), and for the finest mat 10AL2, a significant increase is measured during bed loading with PSL aerosols. In Fig. 7, the relative increase of the DF for an increase of the pressure drop by a factor of 2 is given as a function of the particle size.

During filtration, a layer of aerosol deposits on the filter surface and produces an additional resistance to flow which depends on the properties of the aerosol layer. A visual examination of the filter after the runs revealed indeed the presence of a dust layer on the surface of the bed. No significant penetration into the mass of the filter was determined by 10 x microscope magnification. The deposit of aerosols becomes the filtering medium for succeeding particles which explains the increase of efficiency observed during the two successive runs.

- The main practical informations drawn from these tests are :
- only the 10AL2 gives a good DF. The webs 25 and 40 are not acceptable as gas filtration materials for submicronic aerosols ;
  - for the 10AL2, it is advisable to work at a low superficial velocity

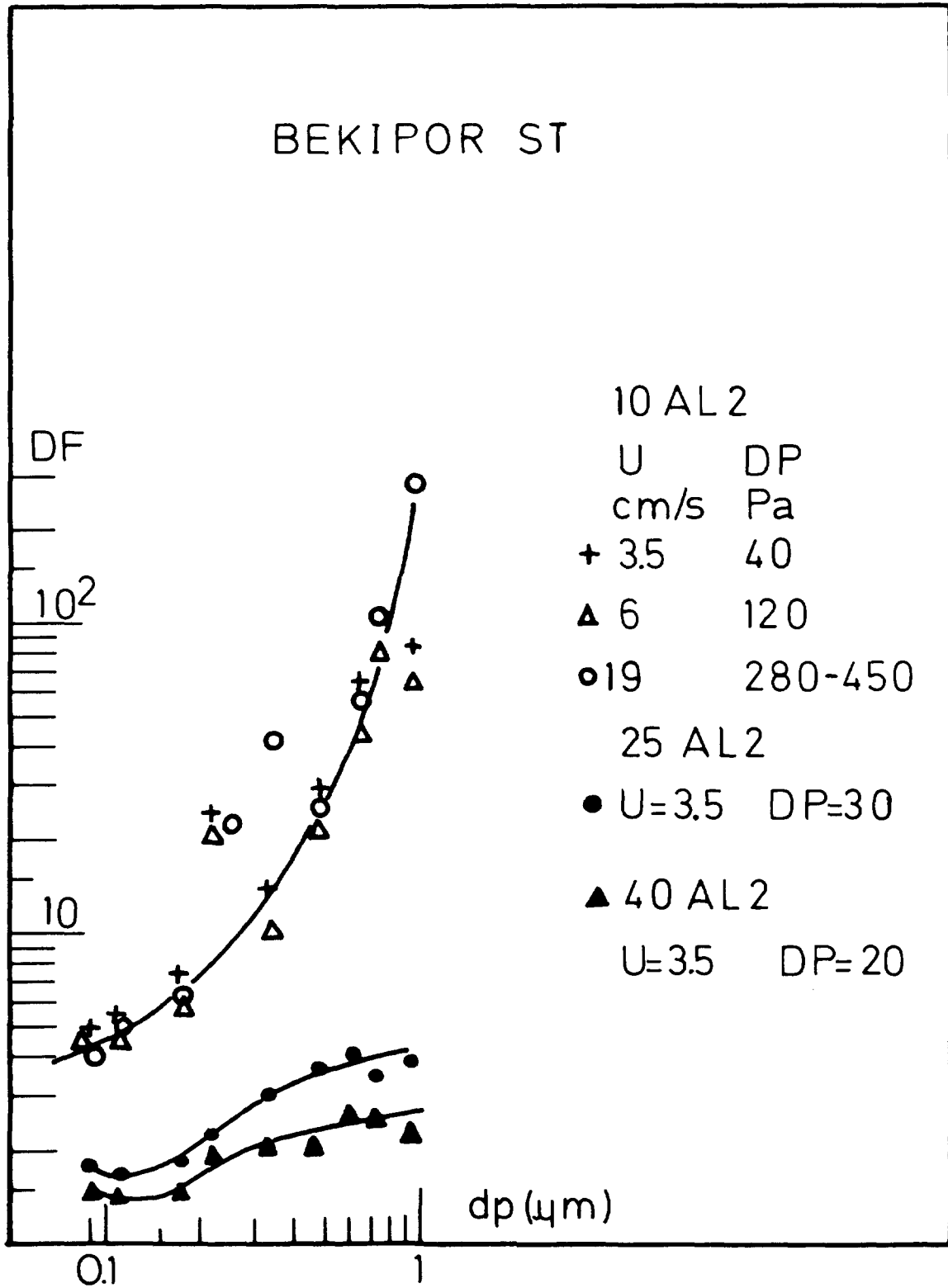

Fig. 6. Parametric study of BEKIPOR ST filter

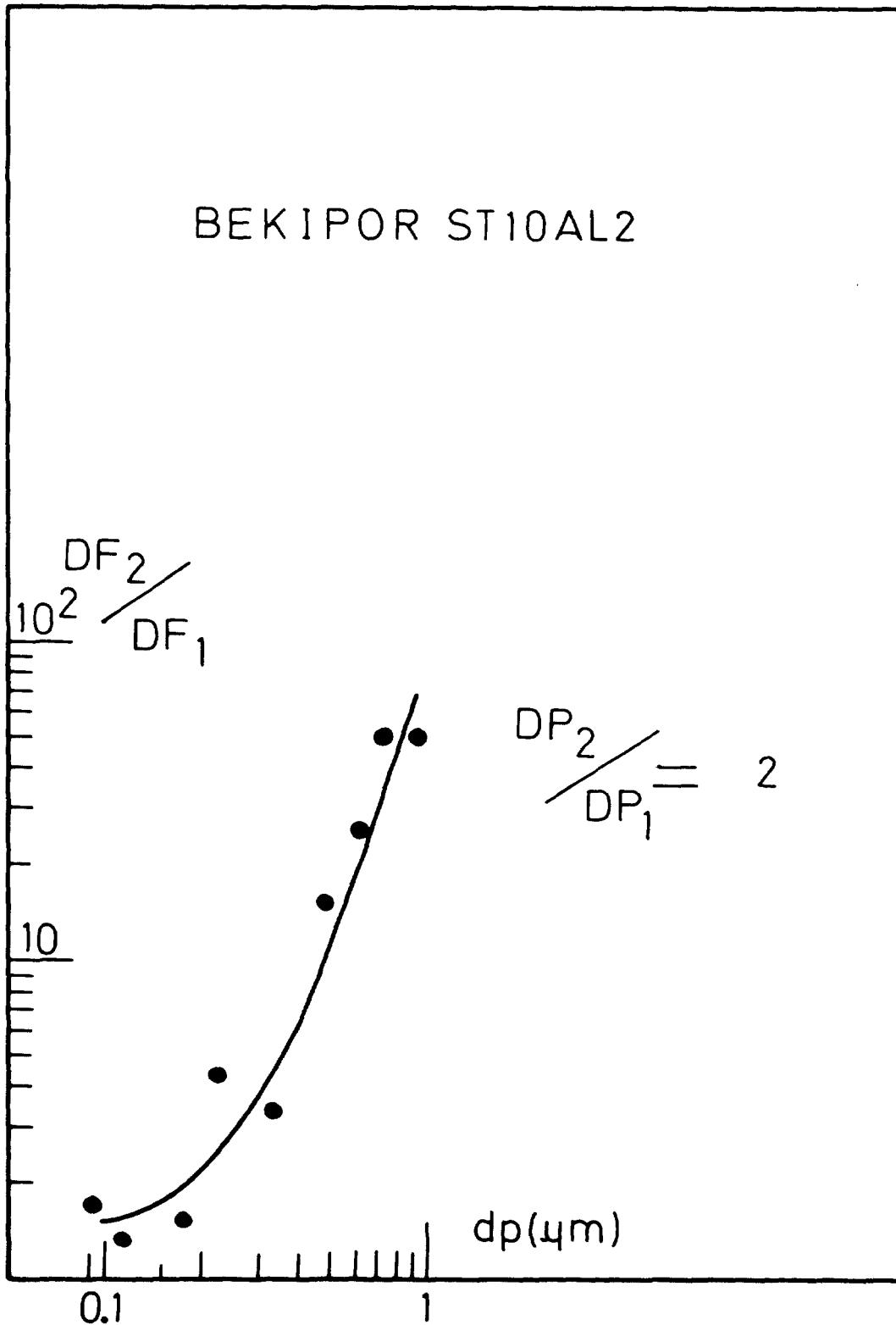

Fig. 7. Relative increase of the DF for a pressure drop increase of a factor 2

## 17th DOE NUCLEAR AIR CLEANING CONFERENCE

i.e.  $u$  smaller than 5 cm/s, in order to have acceptable DP. The effect of the superficial velocity on the DF obtainable with a non-loaded mat is negligible within the experimental detection limits.

The low dependence of the DF on the superficial velocity and the small residence time in the filter indicate that interception is the main filtration mechanism at the superficial velocity range studied. In this case, diffusion plays a minor role in the filtration mechanism. Filtration by the accumulated dust becomes preponderant after a certain operating period depending on the particle size and on the aerosol concentration.

### 7. Study with a candle type filter configuration

The parametric studies performed with flat filters allowed to make a proper choice amongst the different filter materials available. For scaling-up purposes it is however necessary to get information on the filtration performance of the best filter materials chosen under cylindrical geometry in such a way that a candle type configuration can be used. Therefore a study in a candle type filter holder was started using polydisperse aerosols too.

#### 7.1. Description of the experimental procedure

The candle type filter holder contains three candles (useful height : 25 cm ; diameter : 5.2 cm) in parallel so that the filtration area is 1150 cm<sup>2</sup>. The BEKIPOR WB or ST are rolled around the candle in one or several layers. The filtration performance is determined using PSL monodisperse aerosols before and after filter loading with polydisperse methylene blue aerosols. During methylene blue loading, the filtration mass efficiency is determined by sampling filters before and after the BEKIPOR filter and photometric determination of the quantity of methylene blue. The regeneration of the filter after methylene blue loading by washing techniques has also been tested.

#### 7.2. Results with the BEKIPOR WB04 under cylindrical geometry

The BEKIPOR WB04 mat has been tested under the following conditions :

- 5 layers BEKIPOR WB04
- diameter of the candle : •inlet : 90 mm  
  •outlet : 52 mm
- height of the candle : 250 mm
- bed porosity : 0.99
- total flow rate : 15.6 m<sup>3</sup>/h
- mean logarithmic superficial velocity : 2.9 cm/s
- methylene blue aerosol : •concentration : 1.2 mg/m<sup>3</sup>  
                                  •count median diameter : CMD = 0.2 μm  
                                  geometric standard deviation sg = 2.15  
                                  •mass median diameter : MMD = 0.5 μm  
  sg = 1.6

As illustrated in Fig. 8 the DF, measured by methylene blue sampling, increases with bed loading. After a filter loading of 0.87 mg/cm<sup>2</sup> the DF is increased by a factor of 3 while the pressure drop only increased by a factor 1.2.

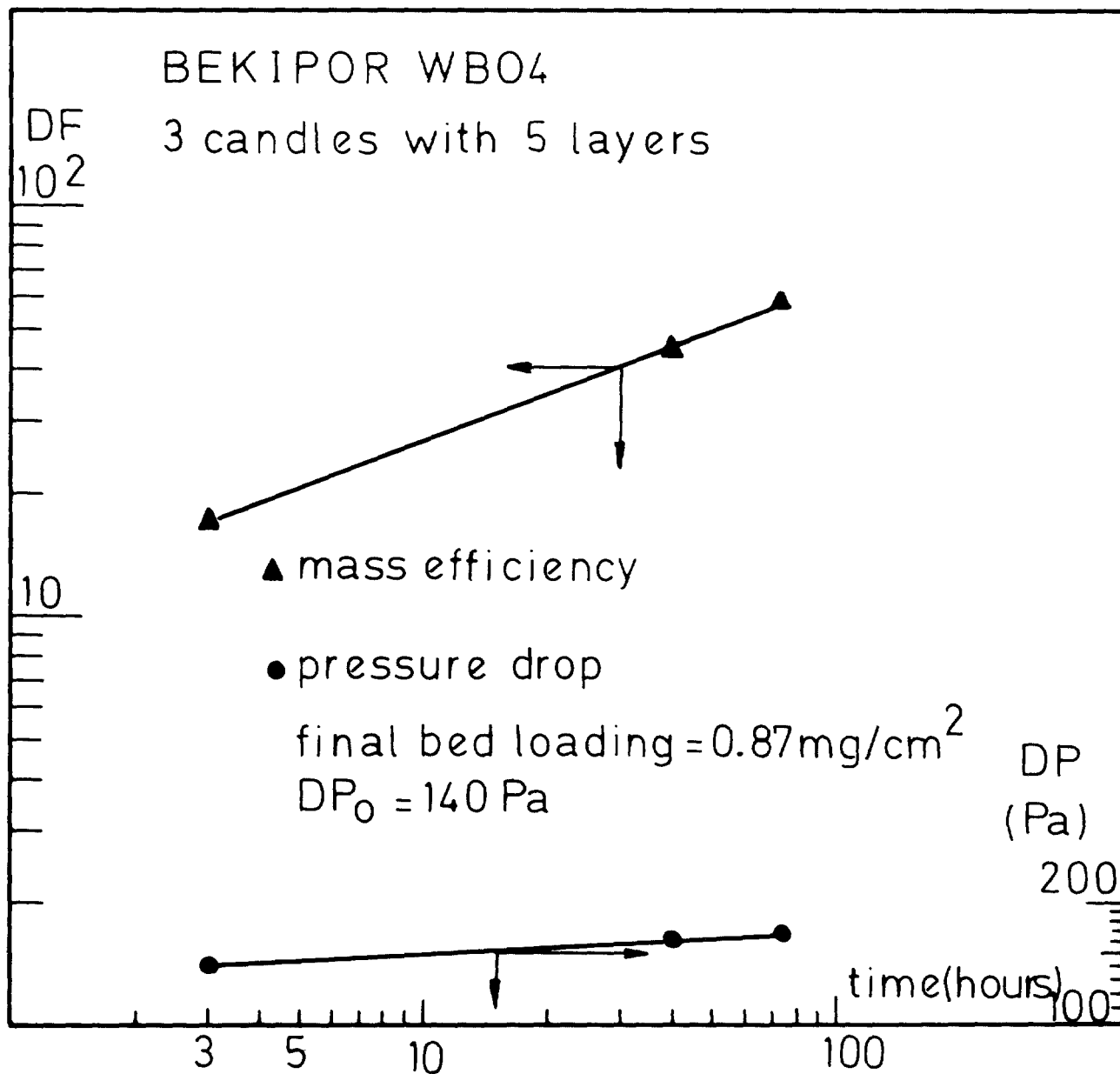

Fig. 8. Efficiency and pressure drop for a methylene blue aerosol

Fig. 9 indicates that the DF for monodisperse PSL aerosols increases again with particle size and that after the filter loading, the DF for each particle size is increased by a factor of 5 to 7.

According to analytical measurements, the quantity of methylene blue inside the filter material decreases exponentially with the bed depth so that the major fraction is accumulated in the first layer of the bed. The regeneration of the filter by water washing has been tested with low pressure jet and spraying nozzles. Good water penetration of the filter and wetting of the fibres is only obtained by spray washing. The drying of the filter by air sparging is very slow mainly because the water tends to accumulate at the bottom of the candle so that all the drying air flows in the upper part where the pressure drop is the lowest and does not remove the water held by capillary forces. Only heating of the air succeeds in removing the accumulated water.

### 7.3. Results with the BEKIPOR ST 10AL2 under cylindrical geometry

The tests of the BEKIPOR sintered mat were performed under the following conditions :

- one layer of ST10AL2 : •diameter 52 mm  
                                  •height 250 mm
- total flow rate : 15.6 m<sup>3</sup>/h
- mean logarithmic superficial velocity : 3.8 cm/s
- concentration methylene blue : 3.9 mg/m<sup>3</sup>
  - CMD = 0.27 µm Sg = 1.85
  - MMD = 0.60 µm Sg = 1.5.

From Fig. 10 it is clear that the DF, measured by methylene blue sampling, increases very rapidly with bed loading. After a bed loading of 0.74 mg/cm<sup>2</sup> the DF is increased by a factor of 20 while the pressure drop is increased by a factor of 5.

Fig. 11 confirms that the DF, measured with monodisperse PSL aerosols, increases with the particle size. After filter loading, the efficiency is increased by a factor of 10<sup>4</sup> for particles greater than 0.3 µm.

Visually, the methylene blue aerosols form a thin layer of deposit on the surface of the filter and nearly no methylene blue is found in the mass of the filter. The removal of methylene blue by water washing is very easy with low pressure jet or spraying nozzle. The drying of the filter by air sparging is very rapid because only a low amount of water remains in the filter after washing.

### 8. Preliminary conclusions and future programme

Stainless steel porous mats BEKIPOR WB and sintered webs ST show good filtration performance in the submicronic range. The dust loading capacity is higher for the porous mats than for the sintered web but on the other hand the regeneration of the sintered web is easier.

- The future programme consists in :
- determination of the regeneration cycle and its influence on the filter characteristics ;

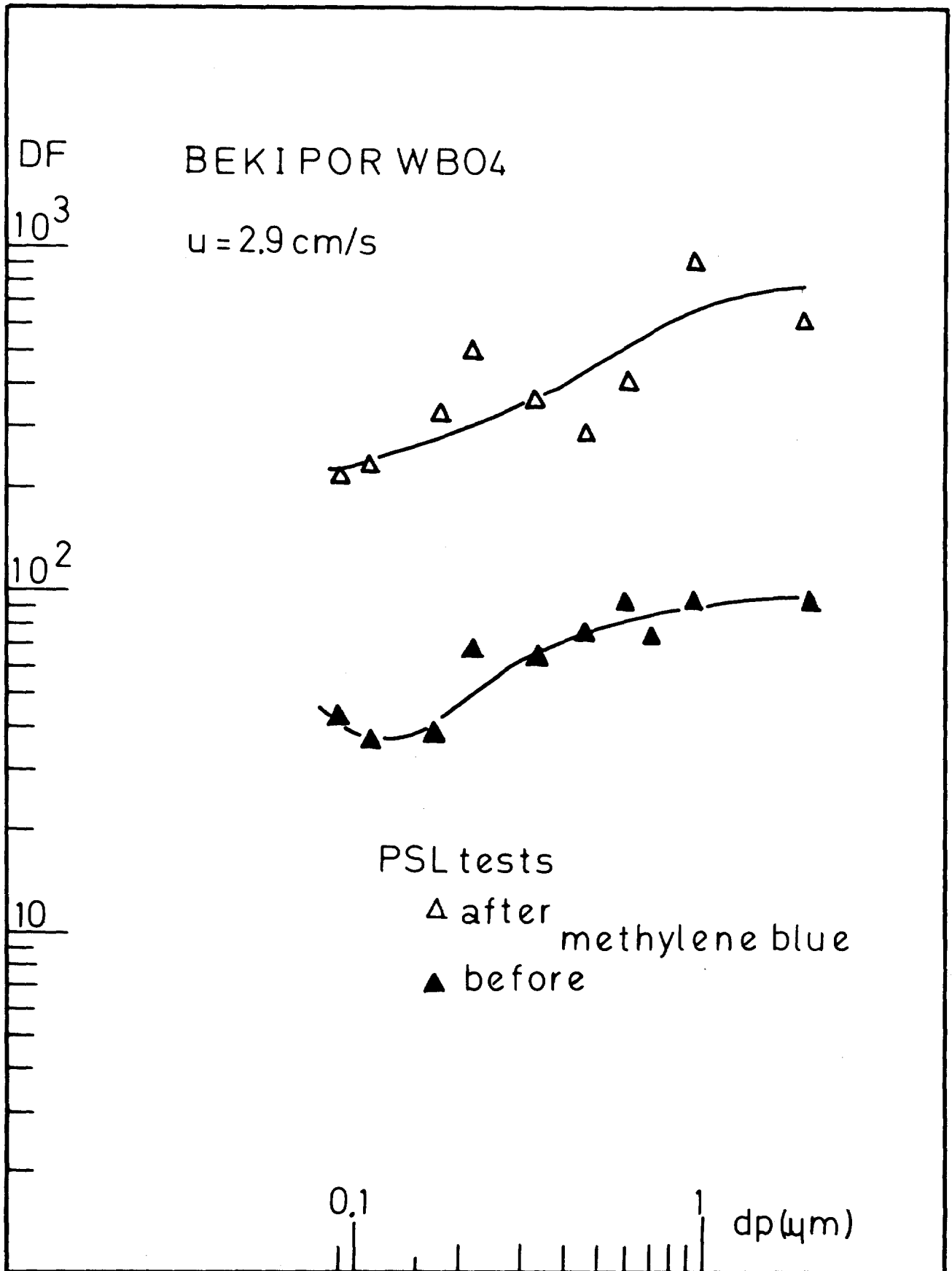

Fig. 9. Efficiency with PSL aerosols before and after bed loading with methylene blue



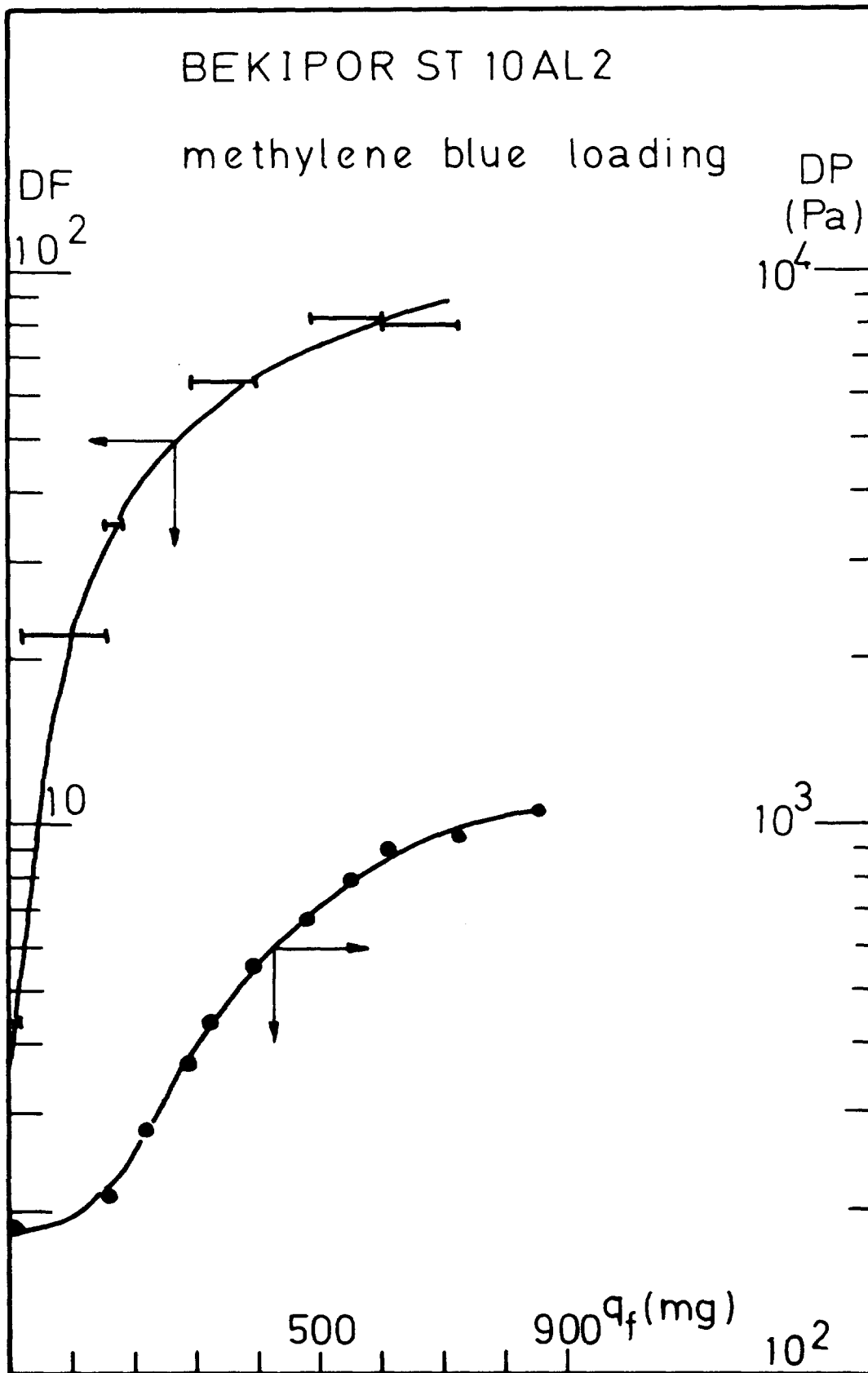

Fig. 10. Efficiency and pressure drop for a methylene blue aerosol

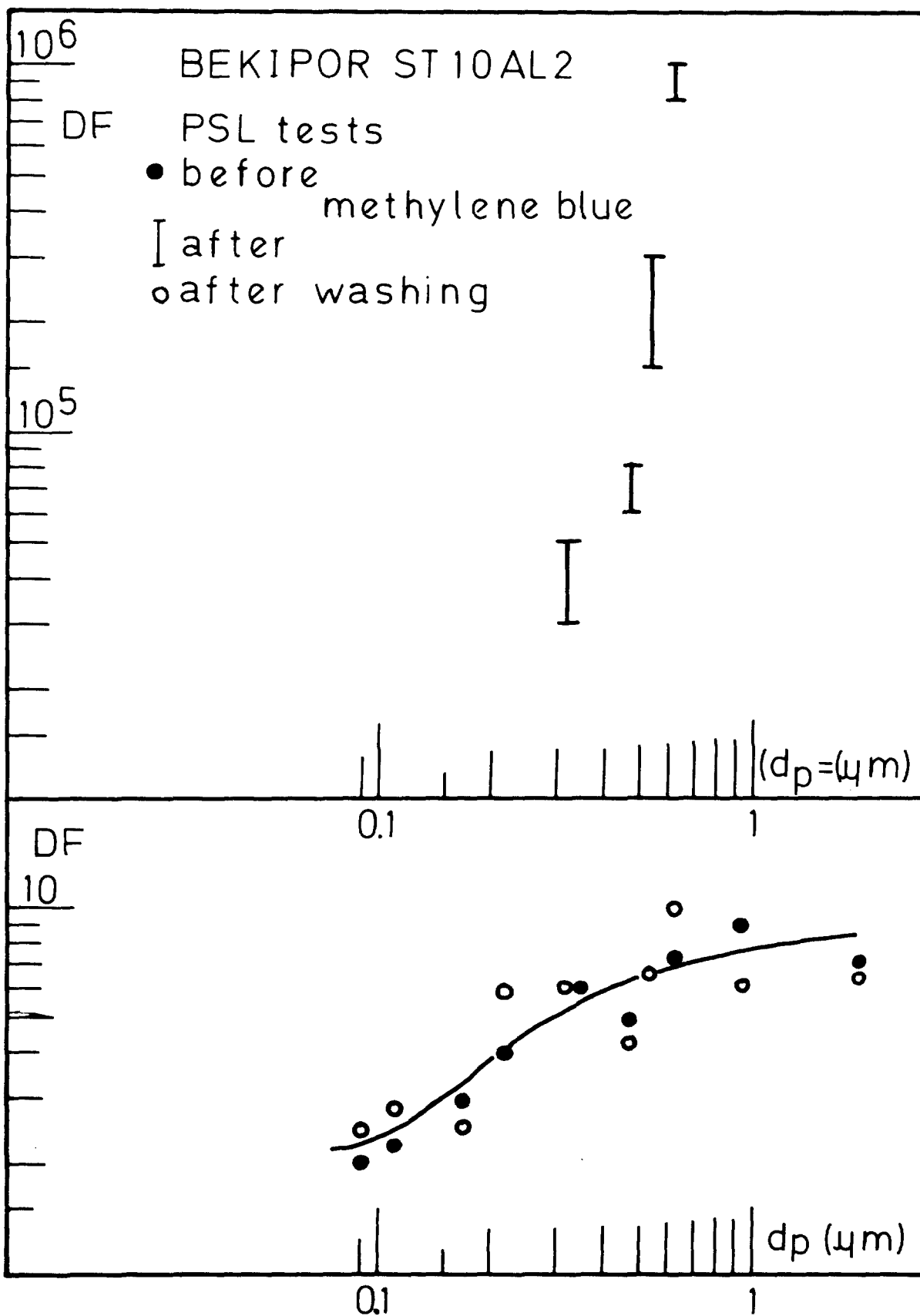

Fig. 11. Efficiency with PSL aerosols

## 17th DOE NUCLEAR AIR CLEANING CONFERENCE

- test of the filter in a high temperature process stream containing NO<sub>x</sub>, water vapour and insoluble aerosols obtained by calcination processes.

### DISCUSSION

BELLAMY: Would you please explain the use of the term "candle"?

KLEIN, Michel: It is a single cylinder of fibrous media; 3 candles would indicate 3 cylinders operating in parallel and considered as one filter.

WATSON: Have you tried multiple regeneration i.e., is there any build-up of filtered material which cannot be removed, hence giving a limited overall life?

KLEIN: Until now, no multiple regenerations have been performed. The future program will be concentrated on the behavior of these filters against insoluble aerosols and with multiple regeneration cycles. It is probable that a build-up of pressure drop will be observed for the two types of filters, but this build-up will probably be smaller for the sintered web (ST) which is regenerated easier.

GERBER: Have these prefilters been put into actual service yet?

KLEIN: No, but we plan to test a sintered type filter (ST) for the filtration of incinerator off-gases. These tests will be performed in the FLK BelgoNucleaire unit handling low level alpha wastes. No other active operation of such filters is foreseen at present.

## EVALUATION OF PERMANENTLY CHARGED ELECTROFIBROUS FILTERS\*

A.H. Biermann, B.Y. Lum and W. Bergman  
Lawrence Livermore National Laboratory (LLNL)  
Livermore, California 94550

Abstract

Permanently charged electrofibrous filters are typically made from fibers of high-resistance polymers with permanent electrostatic charges placed on or near the polymer surface. The permanent charges increase the efficiency of the filter media by providing electrical capture mechanisms in addition to the mechanical capture mechanisms of conventional fibrous filters without increasing the air resistance. Unfortunately, the electrical enhancement can be reduced or even negated by neutralizing the fiber charge via several mechanisms, including charge neutralization by charged particles, formation of conductive paths on the polymer surface, neutralization by chemical attack and environmental conditions such as high temperature.

Our studies have shown that loading the permanently charged filters with captured aerosols will lead to a neutralization of the filter charge. The primary factor controlling the neutralization of filter charge is the charge transfer from the captured aerosol to the fiber surface and the subsequent neutralization of fiber charge. In the case of liquid aerosols (e.g., DOS) the filter efficiency will continuously decrease to the level controlled only by mechanical capture mechanisms. In comparable tests with solid aerosols (e.g., NaCl) the filter efficiency will initially decrease and then increase as it becomes loaded with aerosols. The increased efficiency is due to the additional mechanical capture by the particle deposits. The minimum efficiency obtained during the loading of solid aerosols is determined by the aerosol charge, with highly charged aerosols producing a lower minimum.

We have also shown that permanently charged filters will lose their fiber charge when exposed to organic solvents which chemically react with the surface charge. Ionic water solutions also neutralize the fiber charge when a wetting agent is added to the solutions. Without the wetting agent, water solutions cannot make contact with the fibers and cause only a small deterioration of the fiber charge.

We have attempted to minimize the fiber charge neutralization by coating the charged fibers with a polymer. Several different coating techniques were examined and found to have varying degrees of protection. Unfortunately, preventing the neutralization of fiber charge is not sufficient to prevent a deterioration of filter efficiency. We must also remove the neutralizing agent to avoid a net cancellation of fiber charge. The decrease in filter efficiency on exposure to aerosols and other neutralizing agents places severe restrictions on applications for permanently charged filters.

---

\*This work was performed under the auspices of the U. S. Department of Energy by Lawrence Livermore National Laboratory under contract No. W-7405-ENG-48.

## I. Introduction

Air filters having permanently charged fibers are an effective means for removing submicron aerosols. The permanent surface charges on the fibers add electrostatic collection mechanisms to the mechanical capture mechanisms and increase the performance of the filter with no corresponding increase in pressure drop. These filters are distinguished from other electrofibrous filters in which the fiber charge is continuously maintained by external means such as precharging aerosols or charging or polarizing the filter media with high voltage electrodes. Prior to this investigation of permanently charged filters our study of electrofibrous filters dealt exclusively with electrifying conventional glass fiber filters in an electric field.<sup>(1-7)</sup> Previous investigators have shown that the permanently charged filters have exceptionally high efficiencies, while maintaining a low pressure drop.<sup>(8-10)</sup> However, there is experimental evidence to suggest that filtration of certain aerosols, or exposure of the filters to certain chemicals and environmental conditions, can partially neutralize the fiber charge and cause a significant reduction in filter performance.<sup>(8,11,12)</sup> In this report we present experimental results which demonstrate a discharging of the fiber and our efforts to prevent the discharge and the subsequent deterioration in filter performance.

Our primary incentive for investigating permanently charged filters is illustrated in Fig. 1. Here we compare the efficiency as a function of particle diameter for a standard fibrous filter and for the same filter electrified with external electrification. We can see that electrifying a standard glass fibrous filter (Johns Manville Co., Golden, CO) with high voltage will dramatically increase the collection efficiency. In the same figure we have presented the efficiencies of two permanently charged filters (N. V. Verto Co., Rotterdam, Netherlands); one having a lower pressure drop and one having a higher pressure drop than the standard glass fibrous filter. Ideally, filter efficiencies should be compared with filters having comparable pressure drops. Figure 1 shows that the permanently charged filters have comparable efficiencies in the submicron size range as that of the electrified filter generated by high voltage electrodes. The permanently charged filters achieve the high filter efficiency without all of the equipment required to electrify a standard filter; namely, a high voltage power supply, electrodes and cables. In essence, the major incentive for investigating permanently charged filters is that these filters are able to achieve high efficiencies without requiring the additional equipment for electrification. Unfortunately, these permanently charged filters suffer from a loss of charge, and that loss is the subject of this paper.

## II. Types of Permanently Charged Filters

This paper describes the evaluation of the three most prominent types of commercially available permanently charged filters. Each of the filters is manufactured using a different method for imposing a permanent charge on the fibers. In one method, permanently charged filters are generated from electret sheets.<sup>(9,10,11)</sup> A polymer sheet is initially passed across a corona discharge which imparts positive and negative charges on opposite sides of the polymer sheet. In a subsequent step the sheet is split into small filaments which are then formed into a filter mat using conventional technology for non-woven media. Figure 2 shows a series of scanning electron micrographs of increasing magnification typical of the permanently charged filter formed from electret fibers. In Figure 2A we see an overall view of the ribbon-like shape of the electret fibers. Increasing magnifications show a rough surface structure which we believe plays a prominent role in maintaining a high electrical charge on the

fibers. Electron micrographs of other filter samples show that the surface roughness can become extreme. Figure 3 shows that the rough fiber surface has convoluted to such an extent that a separate surface layer has formed and even pulled away from the bulk surface. An interesting aspect of these electron micrographs is the deposition of salt particles on the surface. Observe that the salt particles have preferentially deposited on the rough, corrugated surface rather than the smooth subsurface. We speculate that this is due to the electrical charges, residing primarily on the rough corrugated outer surface with the subsurface material remaining uncharged. This type of permanently charged filter is manufactured by the N. V. Verto Co., Rotterdam, Netherlands as Filtrete media.

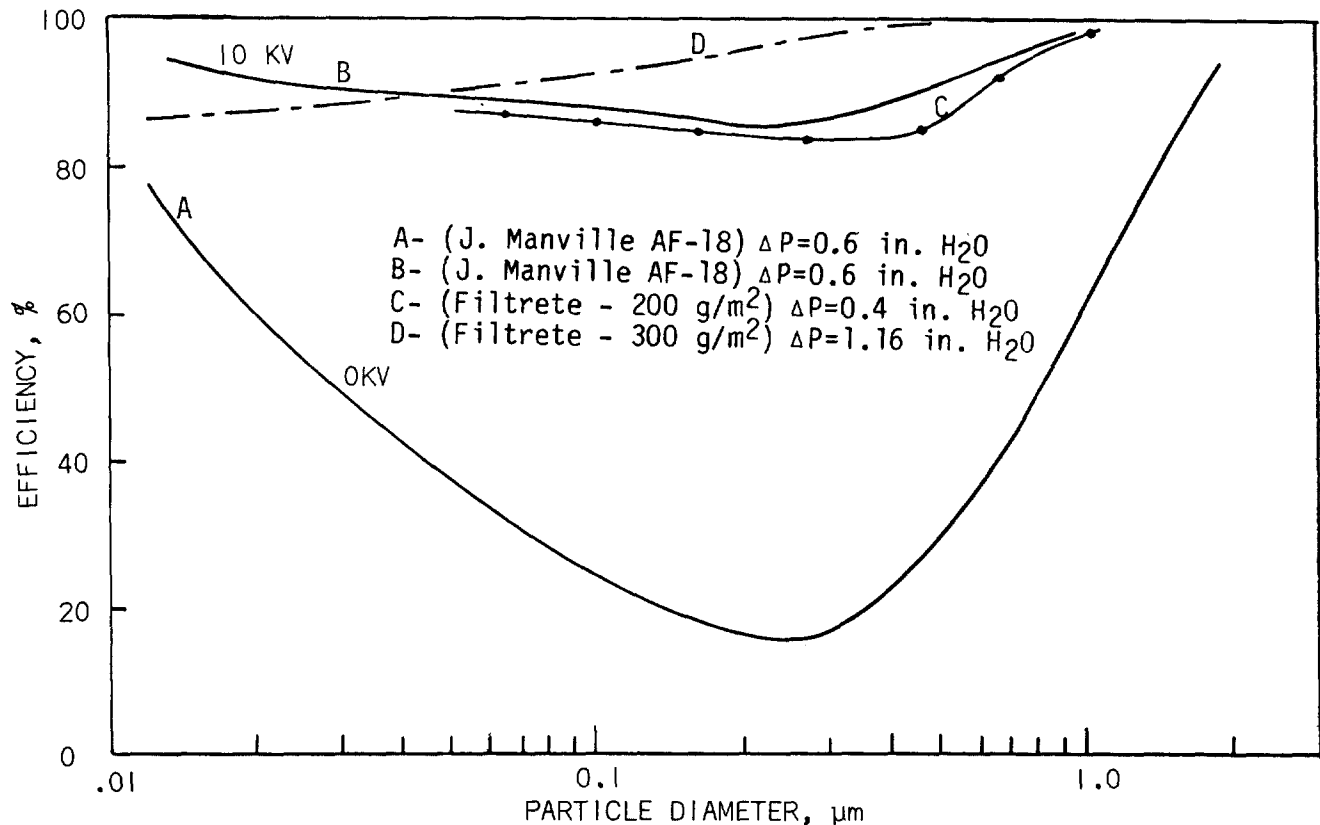

Figure 1. Efficiency of uncharged, externally charged and permanently charged filters, NaCl aerosols,  $U=66$  c/s.

A second class of permanently charged filters is generated by a technique in which high voltage is applied to a polymer melt during a spinning process of fiber formation.<sup>(12)</sup> This filter is commercially available from the Carl Freudenberg Company, Germany. Micrographs of the Freudenberg filter are shown in Fig. 4. This filter consists primarily of relatively smooth fibers arranged in a random fashion to form a filter mat. Their surface is not as rough as seen in the Filtrete media in the previous electron micrographs.

The third class of permanently charged filters is manufactured by coating the fiber surface with charged resin particles. This media is commonly called a Hanson filter and is commercially available from BIS Minerals Limited, London, England as Capofilters. Electron micrographs of this class of permanently charged filters are shown in Fig. 5. We can see the fibers are heavily coated with resin particles which support all of the charge on the filter media.

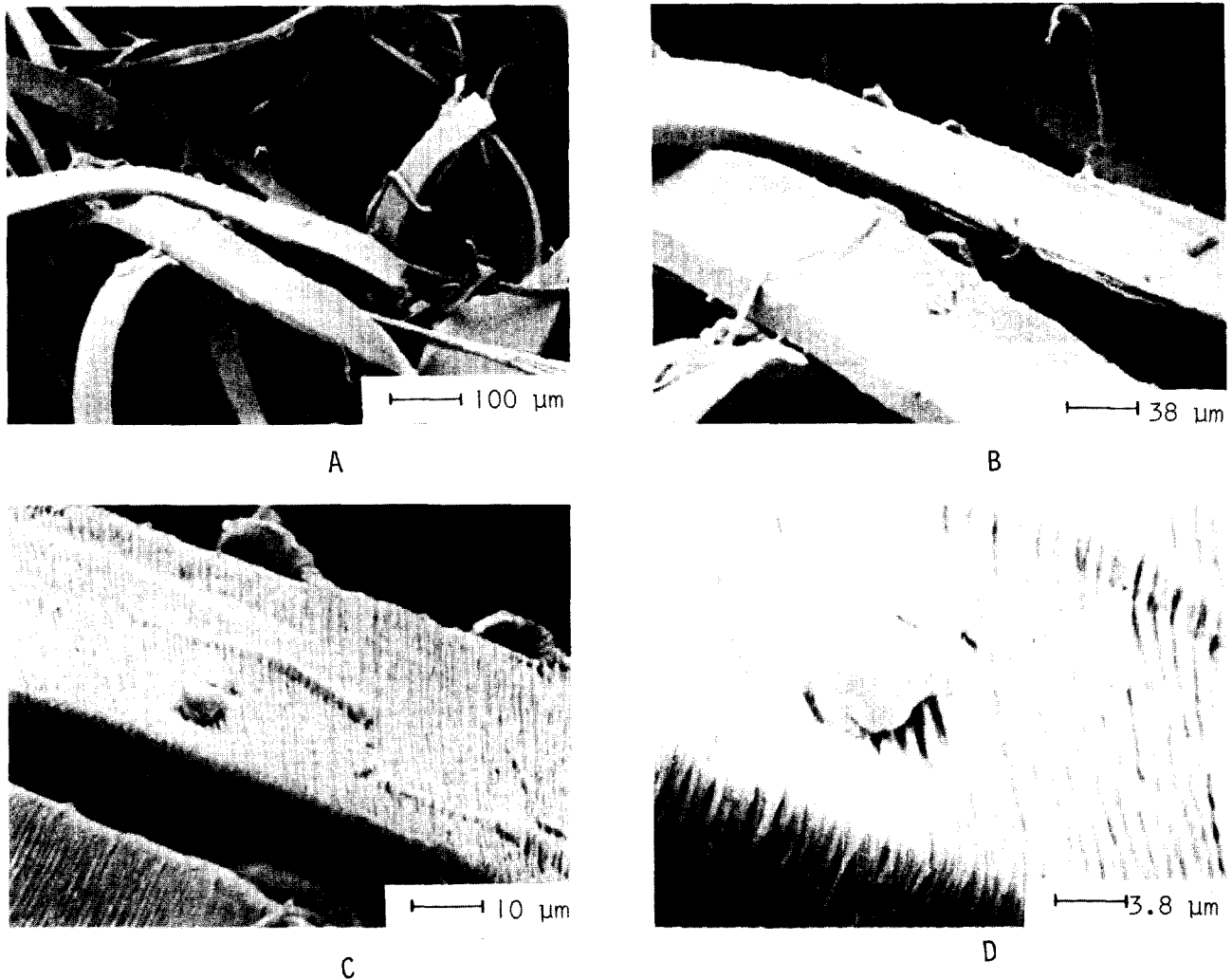

Figure 2. Scanning electron micrographs of Filtrete media.

### III. Experimental Apparatus

We conducted an experimental evaluation of the permanently charged filters in our small-scale filter test facility. The experimental test arrangement used in evaluating three filters is illustrated in Fig. 6. The experimental test array consists of an aerosol generator, a test duct, filter holder, a blower, diagnostic aerosol instrumentation, and a computerized data acquisition system. A Climet 208 particle counter is used to measure the particle concentration as a function of particle diameter in the 0.3 - 10.0 μm diameter range. The Climet sample is usually diluted 25:1 prior to sampling to avoid coincidence errors in the optical counter. A Thermo Systems, Inc., Model 3030 electrical aerosol analyzer measures the particle concentration as a function of particle diameter in the 0.01 - 1.0 μm diameter range. When these two instruments are used to sample both upstream and downstream of the test filter, the collection efficiency as a function of particle size can be calculated. In addition, an aerosol photometer (Phoenix Precision Instrument, Model JM-7000) measures the

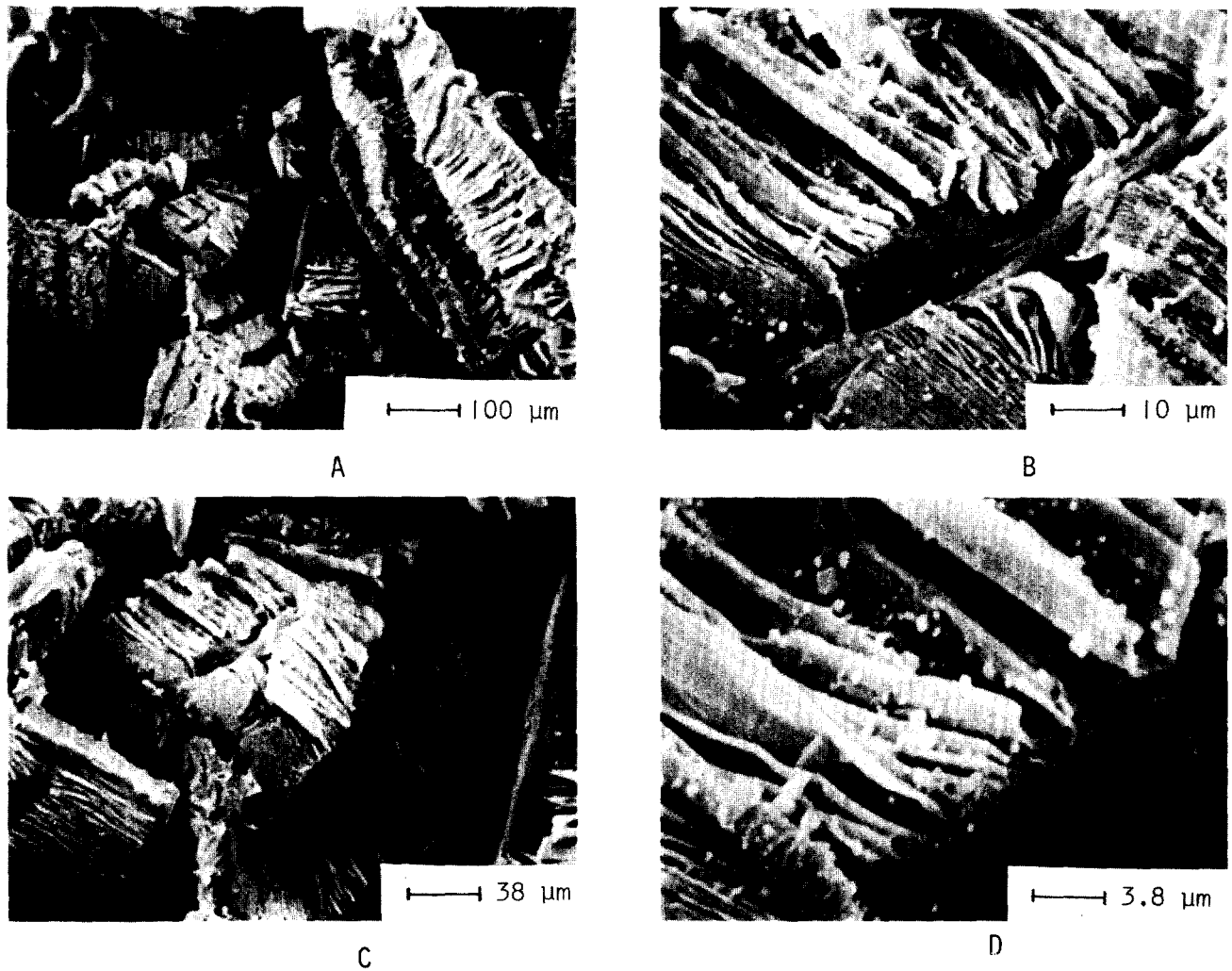

Figure 3. Scanning electron micrographs of Filtrete media with NaCl.

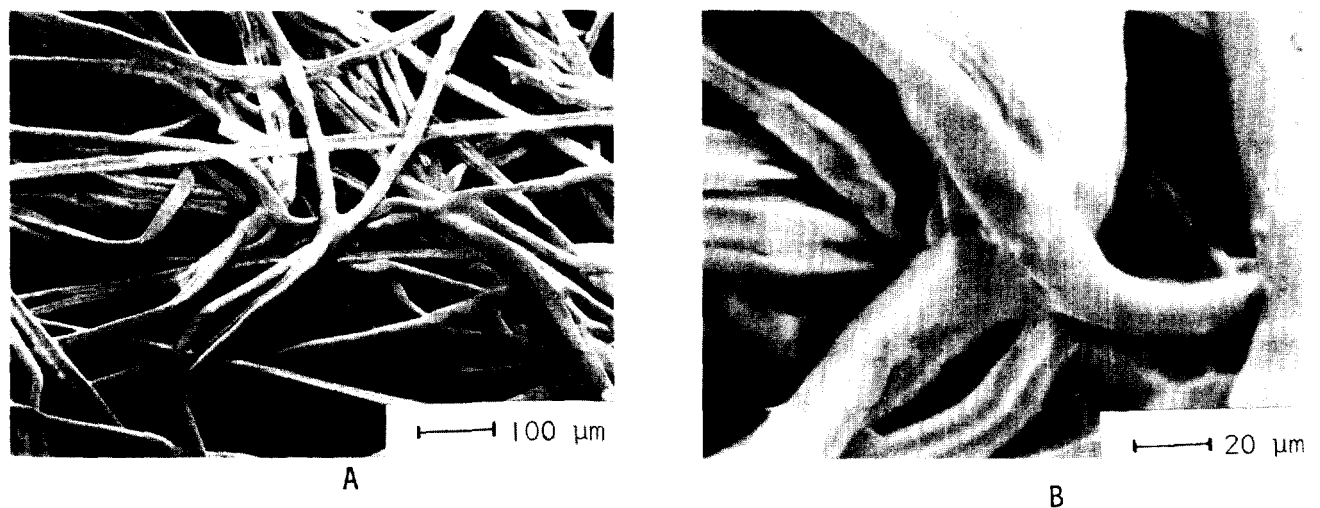

Figure 4. Scanning electron micrographs of Freudenberg media.



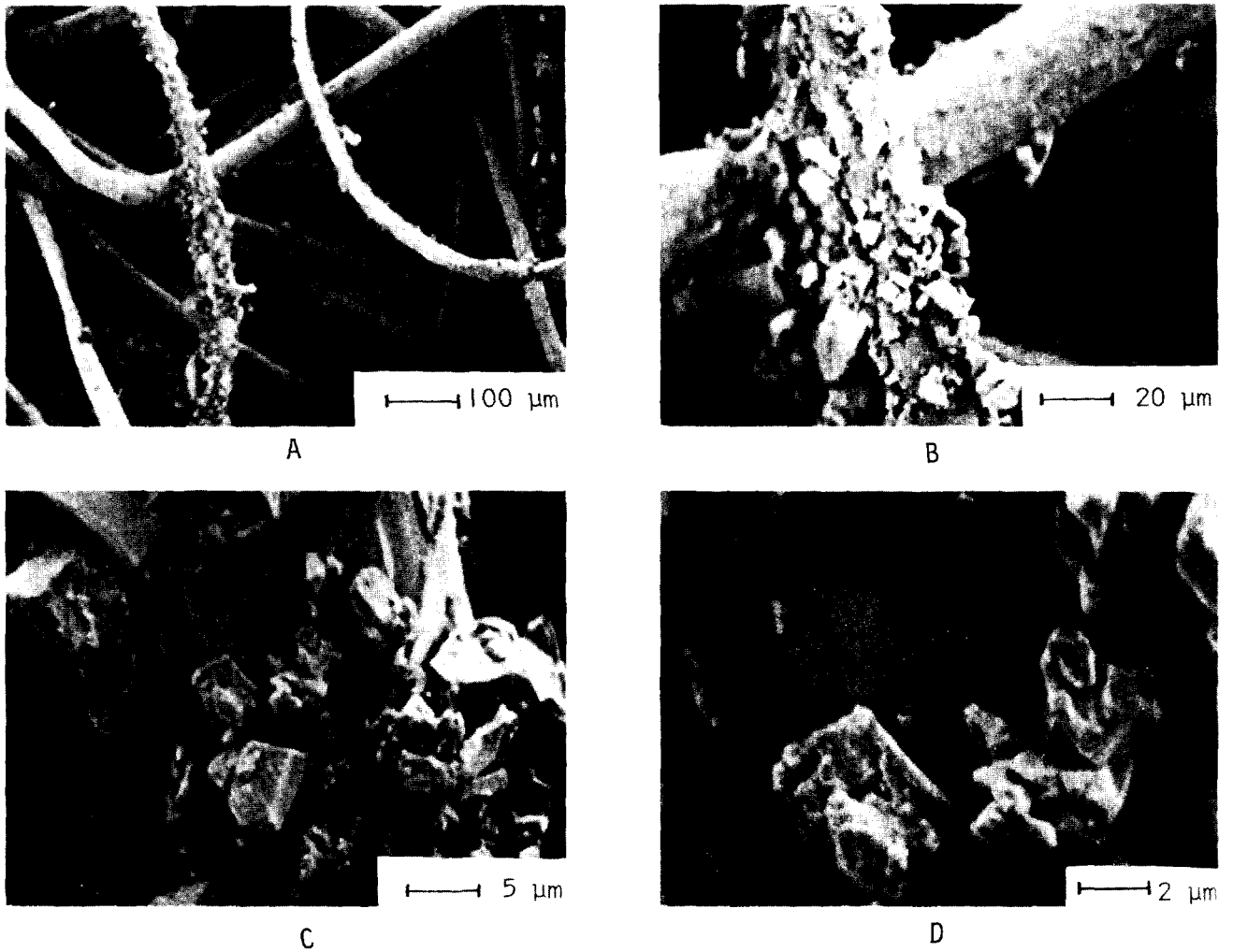

Figure 5. Scanning electron micrographs of capofilter media.

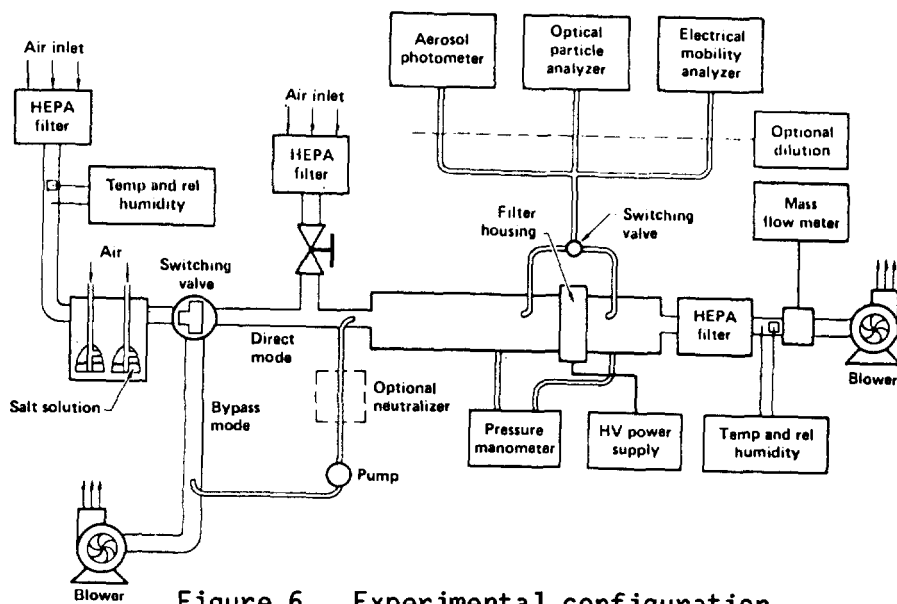

Figure 6. Experimental configuration.

integrated light scattering intensity from all sampled aerosol particles and indicates an overall filter performance. All of the instrumentation, along with monitors for air flow rate and filter pressure drop are interfaced to an LSI-11/23 computer. The aerosol concentration and size distribution, and filter face velocity are maintained constant for each filter evaluation. The experimental data presented in this report were conducted at face velocities,  $U$ , of 13 or 64 cm/s, using filters having an area of 317 cm<sup>2</sup>.

Computer codes have been developed to allow the operator to accumulate, process, save, and plot particle size distribution and filter penetration data. Computer output includes status messages to the operator, hard copy plots, disk-file data storage, and raw and reduced data line-printer listings. A photo of the laboratory facility is shown in Fig. 7.

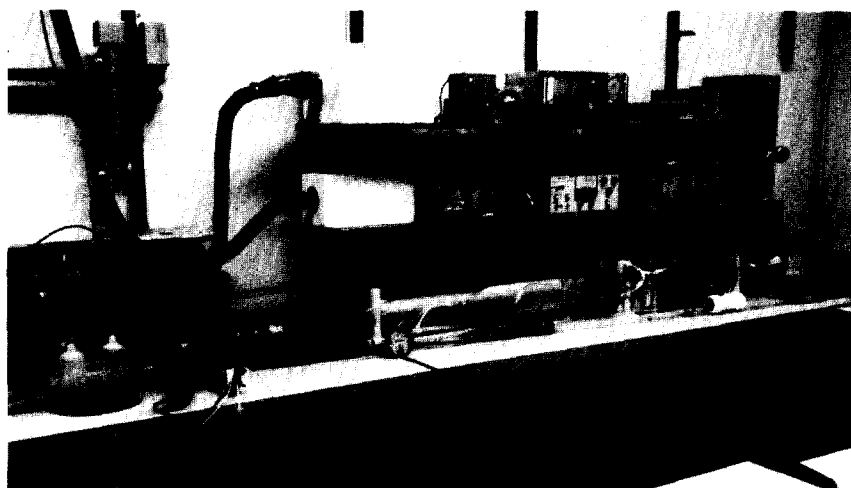

Figure 7. Photo of the laboratory facility.

### IV. Experimental Results

#### Liquid and Solid Aerosol Loading

Figure 8 shows a typical result of the efficiency and pressure drop obtained with the 200 g/m<sup>2</sup> Filtrete media in which two classes of aerosols were loaded on the filter. We used sodium chloride aerosols to simulate a solid particle loading, and dioctyl sebacate (DOS) aerosols to simulate liquid particle loading. The filter loading with sodium chloride aerosols shows an initial decrease in efficiency followed by a rapid increase. We have attributed the initial decrease to the neutralization of the filter charge by the charged aerosol particles depositing on the filter. The subsequent increase in efficiency is due to the mechanical capture of new particles by the previously deposited particles. Note that the point at which the efficiency increases corresponds closely with a rapid rise in pressure drop. This behavior would be typical for any solid aerosols; namely the conversion from primarily an electrical capture mechanism to that of mechanical capture. The mechanical capture in this case is due primarily to the previously deposited solid aerosols rather than the fibrous media. The depth of the minimum depends on the aerosol charge to which the filter is subjected; the higher the charge on the aerosol, the lower the minimum efficiency.

In the case of the DOS aerosol loading, we see a continual decrease in efficiency and relatively no change in pressure drop as the aerosol is loaded on the filter. The decrease in filter efficiency is due to the neutralization of fiber charge as the charged DOS aerosols deposit on the fibers. In contrast to the case of NaCl loading, there is no minimum and subsequent increase in efficiency as the filter becomes loaded with DOS aerosols. This occurs because the liquid DOS aerosols do not form a particle deposit that significantly increases the mechanical efficiency of the filter. An increase in the mechanical collection efficiency is normally reflected in a rise in pressure drop with increasing particle loading. This does not occur for DOS aerosols.

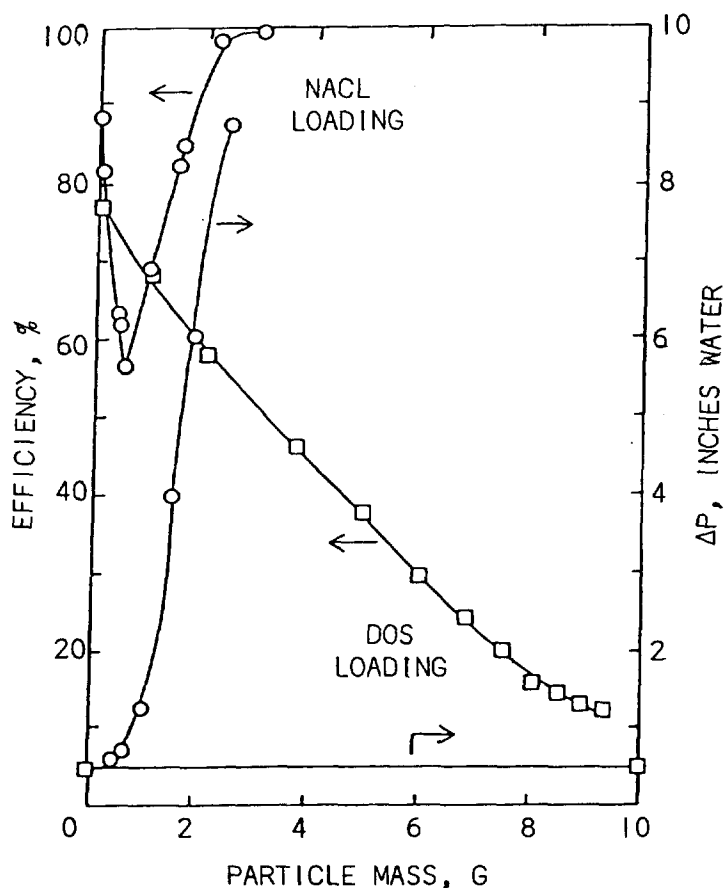

Figure 8. Filtrete 200 g/m<sup>2</sup> performance with aerosol loading, U=64 cm/s.

Electron micrographs were taken of the deposits formed with solid NaCl aerosols (Fig. 9) and liquid DOS aerosols (Fig. 10). Although the electron micrographs shown in Figs. 9 and 10 were not taken from the same filters used to generate the data in Fig. 8, they do show the primary difference between deposits of solid and liquid aerosols. Figure 9 shows the NaCl deposits after the Filtrete media had gone just beyond the minimum efficiency and was beginning to increase in efficiency due to the additional mechanical capture mechanism of the particle deposits. Figure 10 shows a deposit of 3.8 grams of DOS aerosols that have uniformly coated the fiber surface. The uniform coating occurs because the DOS liquid wets the fiber and spreads out over its surface. Liquid aerosols that do not wet the fiber surface would not spread out and would remain as individual particles or would coalesce into larger droplets. Since the DOS particles do not form a dendritic structure but rather smoothly coat the fibrous surface, there is no corresponding increase in mechanical collection mechanisms to capture subsequent particles. Hence, with increasing loading of DOS aerosols the only effect is to neutralize the charge on the fibers. The contrast between the two types of aerosol loading on the permanently charged filter is reflected in the corresponding pressure drops shown in Fig. 8. For the liquid aerosols we see a negligible increase in pressure drop during the period of loading; whereas for the solid aerosols there is a very dramatic increase in pressure drop with loading.

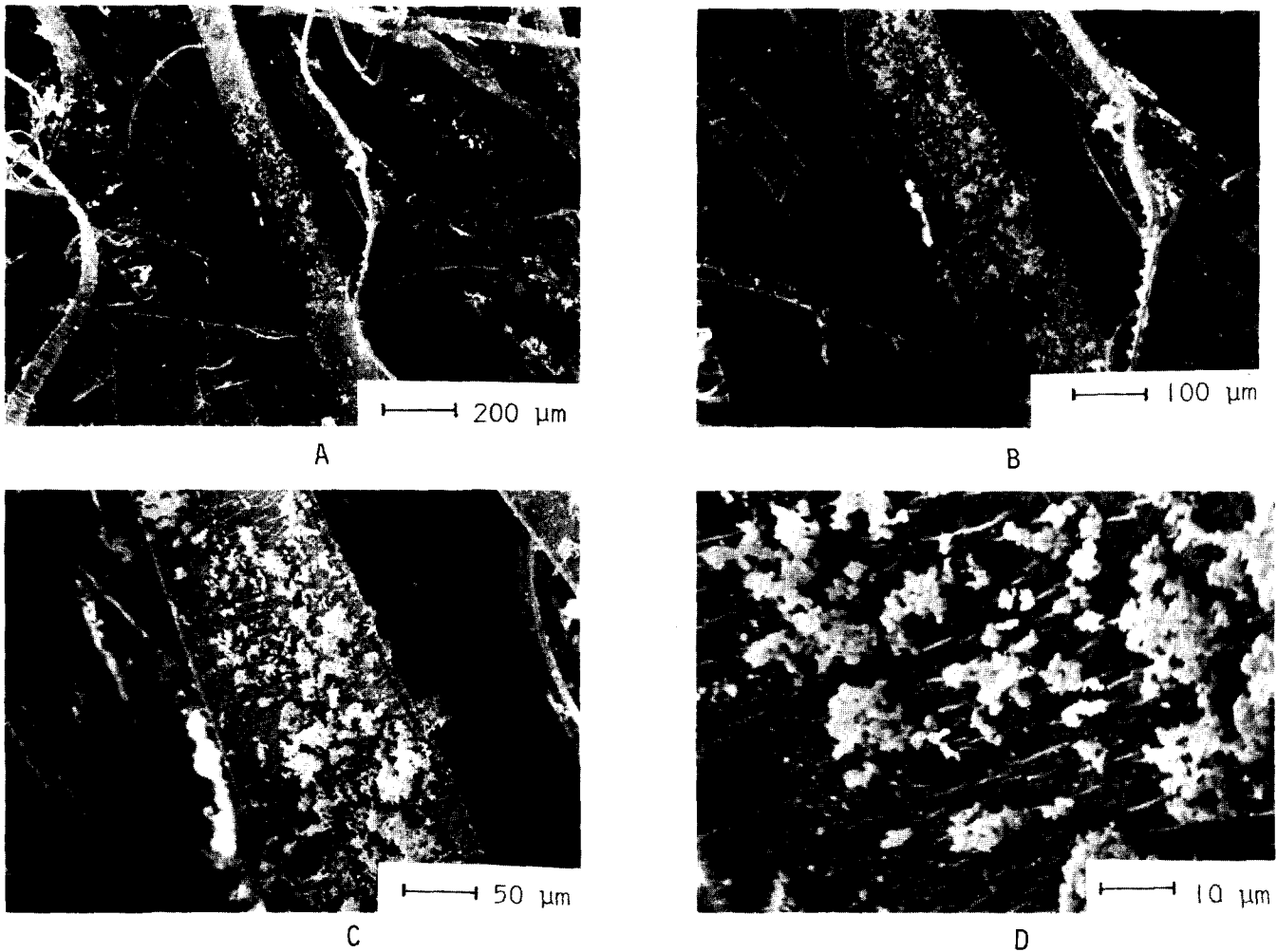

Figure 9. Electron micrographs of Filtrete fibers having NaCl deposits.

Another difference observed in Fig. 8 between particle loading with NaCl and DOS aerosols is the more rapid decrease in filter efficiency with NaCl deposits than with DOS deposits. This observation applies up to the point where the particle deposits make a significant contribution to the mechanical efficiency. After accounting for particle mass, we calculate that the filter loses 100% of its efficiency with NaCl aerosols and 10% with DOS aerosols. Thus, on a particle mass basis the filter efficiency decreases 10 times faster with NaCl aerosols than with DOS aerosols. However, this comparison based on particle mass is not valid since the density of NaCl is 2.17 g/cc and DOS is 0.92 g/cc. Accounting for the differences in density we calculate that, based on a particle volume basis, the filter efficiency decreases 24 times faster with NaCl aerosols than with DOS aerosols. Since the size distributions of NaCl and DOS aerosols are similar (AMMD is 0.8  $\mu\text{m}$  for NaCl and 0.9  $\mu\text{m}$  for DOS) the relative decrease in filter efficiency with equal volumes of aerosols will approximate the decrease predicted for individual NaCl and DOS particles. We have found that the increased filter deterioration with NaCl aerosols is due to the higher charge on the NaCl aerosols compared to the DOS aerosols. The aerosol charge distributions were measured using a Thermal Systems, Inc. electrostatic classifier, Model 3071. The procedure was described by Knudsen

and Whitby(13) and detailed in the TSI instruction manual.(14) Figure 11 compares the measured aerosol charge distributions showing the percent number below stated charge as a function of particle charge. This figure shows that 85% of the DOS aerosols have less than 10 electron charges per particle, while 85% of the sodium chloride aerosols have less than 200 electron charges per particle. Thus, the more highly charged sodium chloride aerosol results in a more rapid neutralization of the permanently charged filters than does the DOS aerosol.

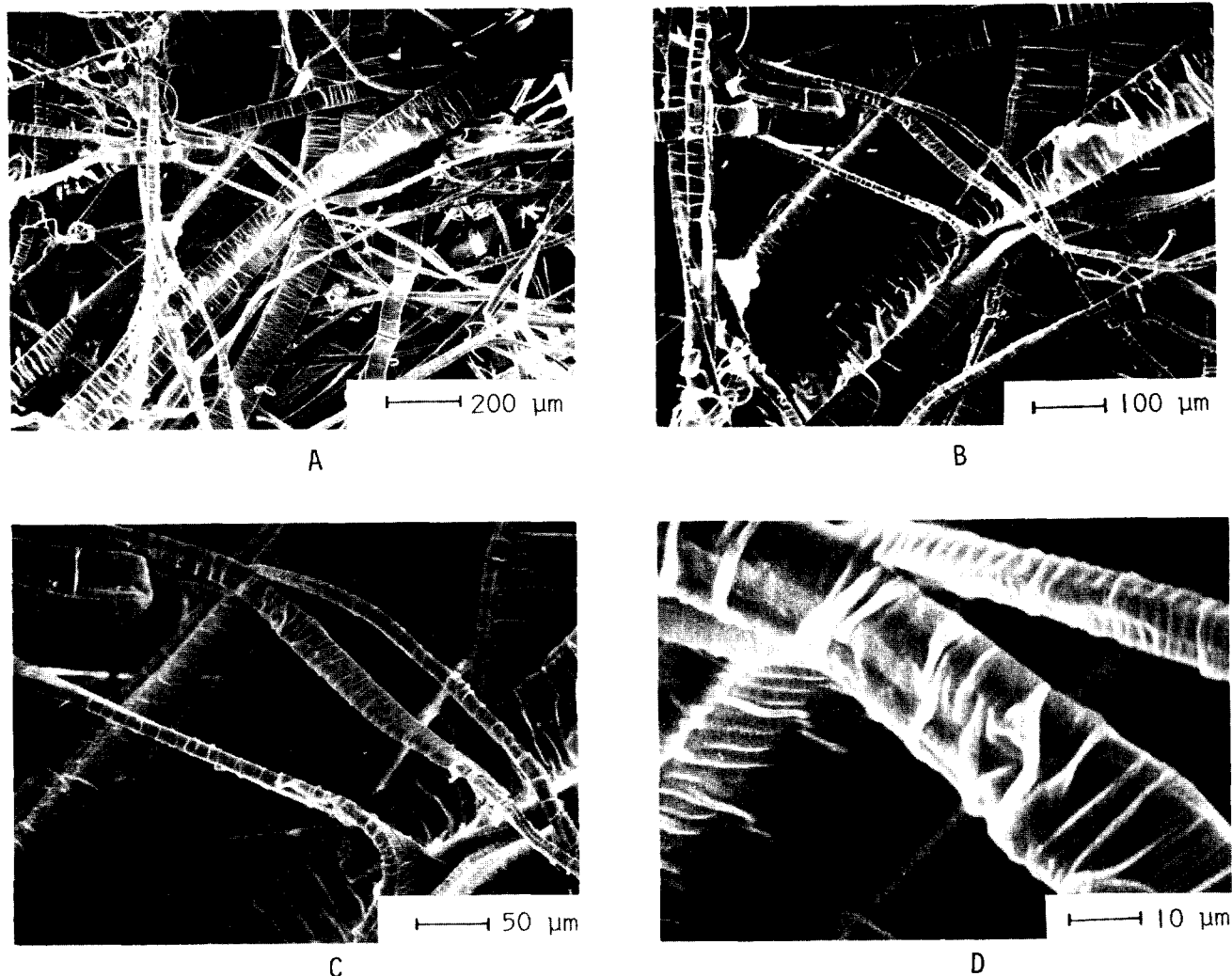

Figure 10. Electron micrographs of Filtrete fibers having DOS deposits.

In our experimental evaluation we also measured the aerosol penetration as a function of particle diameter at each stage of filter loading for NaCl and DOS aerosols. The penetration as a function of particle diameter for NaCl aerosols is shown in Fig. 12 where the penetration curve for an initially clean filter is compared with three additional penetration curves corresponding to increasing deposits of sodium chloride on the filter media. Note that the penetration at

all particles sizes initially increases with loading up to 0.5 grams and then decreases with further aerosol deposition. In addition to the general trend of increasing penetration, reaching a maximum and then decreasing penetration, note that the point of maximum penetration has shifted to smaller particle diameters with increasing particle loading. The particle size of maximum penetration has shifted to smaller sizes with increasing particle loading because the dominant collection mechanism has shifted from electrical capture to mechanical capture by the particle deposits that develop on the fibers. We have shown previously that the particle size of maximum deposits produces a filter having a smaller effective fiber diameter.<sup>(6)</sup>

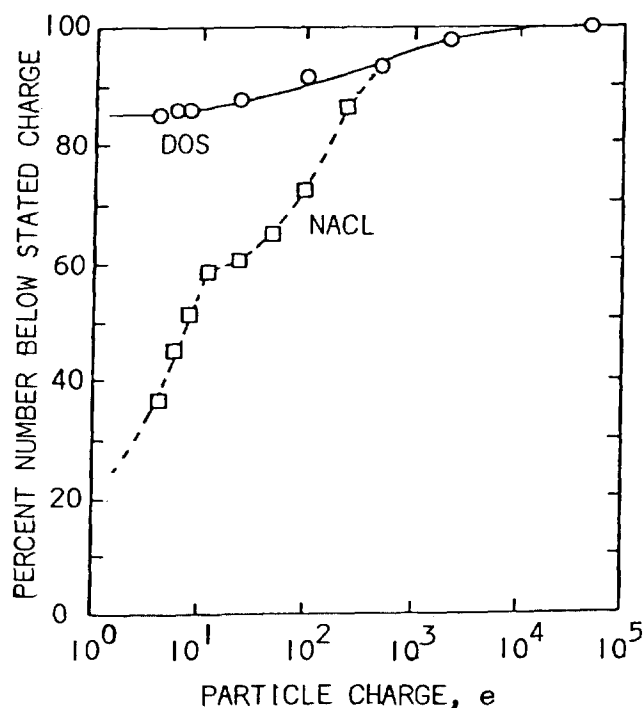

Figure 11. Charge distributions for NaCl and DOS aerosols.

Measurements of the aerosol penetration is shown in Fig. 13 as a function of particle diameter for increasing loadings of DOS aerosols. This figure shows the penetration at zero particle mass loading, and at DOS loadings of 1.6 and 3.3 grams respectively. In this case, the primary trends are primarily an overall increase in the penetration at all particle sizes and an apparent shift in the particle diameter having maximum penetration to larger particle diameters. The diameter of maximum penetration shifts to larger particle diameters because of the loss of electrical attractive forces in the permanently charged filters. In our previous work with externally applied electric fields to generate electrofibrous filters, we have noted that the electrical attraction for larger sized particles is not dependent on particle charge<sup>(4)</sup>. We have found previously that the filter efficiency for particles larger than 0.5  $\mu\text{m}$  diameter is the same for an electrofibrous filter with either charged aerosols or neutral aerosols. In contrast, the efficiency for particles smaller than 0.5  $\mu\text{m}$  diameter is strongly dependent on the particle charge. We concluded that larger particles are collected by a polarization attraction while the smaller particles are collected by a Coulombic attraction. For permanently charged filters, the larger particles are polarized by the electric field generated by the charged filters. Thus, for neutral aerosols or aerosols having a low charge, an electrified filter would show a higher efficiency for the larger aerosols than for the smaller aerosols. This results in a filter efficiency curve with the minimum falling at the small particle size range. When the electrified filter is neutralized, the polarization attraction is lost and the minimum efficiency shifts to a larger particle size. In our experiments with externally applied electric fields, the diameter of maximum penetration shifted from smaller sizes to larger sizes when the electrofibrous filter was neutralized.<sup>(4)</sup> We believe the same phenomena is responsible for the shift in peak penetration to larger particle sizes when the permanently charged filter is neutralized.

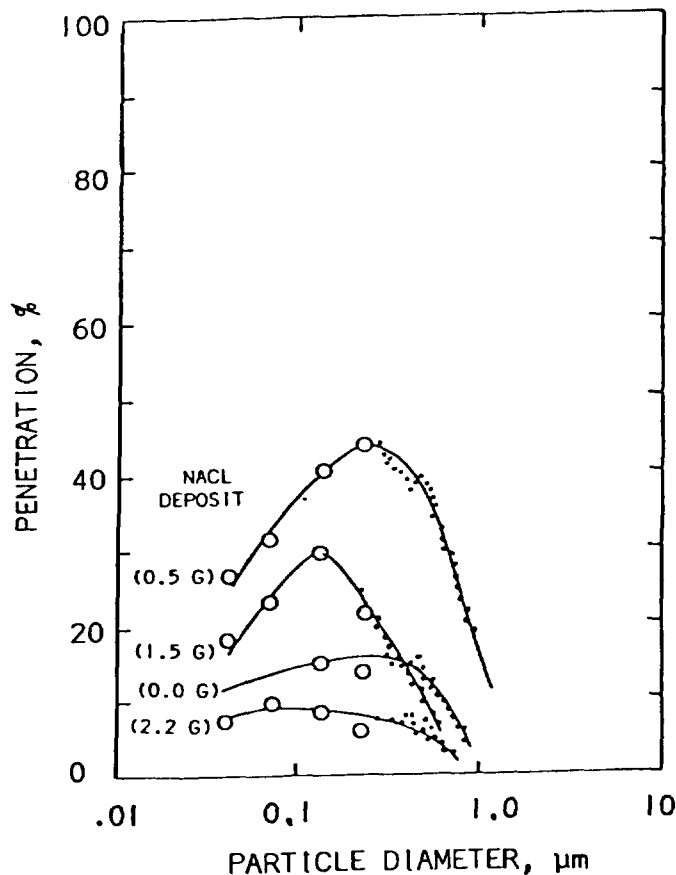

Figure 12. Aerosol penetration at increasing mass loading for NaCl aerosols, Filtrete 200 g/m<sup>2</sup>, U=64 cm/s.

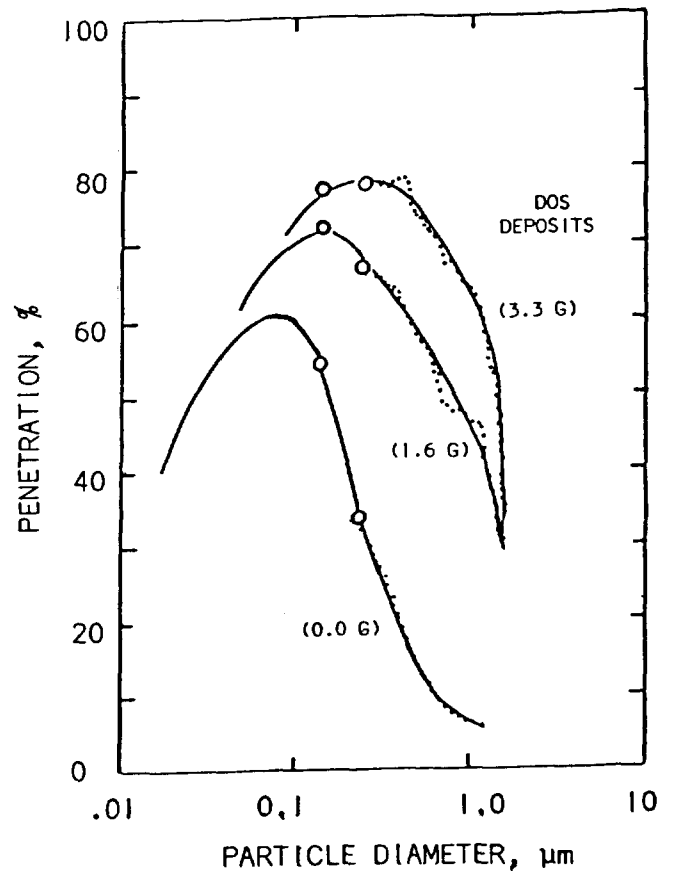

Figure 13. Aerosol penetration at increasing mass loading for DOS aerosols, Filtrete 200 g/m<sup>2</sup>, U=64 cm/s.

### Media Exposure to Water Solutions

We have just examined the deterioration of the permanently charged filters with respect to normal operating conditions; namely, the loading of solid and liquid aerosols. In addition to the normal exposure of aerosols, we have found that permanently charged filters may also lose some of their efficiency due to environmental conditions, the most prominent of which is exposure to water. We have measured the efficiency of the permanently charged filters before and after immersing in water solutions. Filters were immersed in the solutions for approximately 30-40 minutes, rinsed three times and allowed to dry. This relatively drastic test was conducted to simulate the extreme case of a saturated filter that could arise in high humidity conditions. We conducted a number of experiments to measure the effect of water exposure on the filter efficiency. Figure 14 shows the efficiency indicated by aerosol photometer measurements before and after rinsing with water solutions for a number of different solutions beginning with pure water, then water and acid, water and salt, then water and a surfactant, and finally water and sodium chloride and a surfactant. We see, for the case of pure water, a very slight deterioration of the efficiency on immersing the filter in water. This slight deterioration we attribute to the neutralization of charge readily accessible on the surface of the filter media. Immersing the filter in a water plus nitric acid solution shows a very similar deterioration. Identical results were also obtained with a

solution of water and sodium chloride. We added the acid and sodium chloride in an effort to see if the ions would cause additional deterioration of the charge. In fact, we saw no further deterioration due to the ions.

Since these water solutions were unable to wet the fiber surface we surmised that the reason we were unable to lower the filter efficiency due to fiber charge neutralization was strictly mechanical; namely that the solution was unable to make physical contact with the filter surface. To test this hypothesis we immersed the filter in a water solution having a surfactant. The results were similar to the immersion in pure water alone. In this case, we had a relatively modest deterioration in the filter efficiency after immersion. Again, we attribute this deterioration to the fiber surface charge being readily neutralized on the filter surface. However, when we added sodium chloride to the water and surfactant solution we observed a dramatic decrease in filter efficiency thereby verifying our hypothesis. Thus, we see that the additional ions from the sodium chloride will indeed neutralize the filter charge if we are able to wet the fiber by means of a surfactant.

In addition to the aerosol photometer measurements, we have also measured the filter penetration as a function of particle diameter before and after rinsing for each of the water solutions listed in Fig. 14. The results are shown in Fig. 15. Indicated efficiencies by each curve are those from the aerosol photometer data. Along with the general trend of increasing penetration we again note the shift in the diameter of maximum penetration toward larger particle sizes as the permanently charged filter is neutralized.

#### Media Exposure to Organic Solvents

Another adverse environment that is examined is exposure to organic solvents. This is an important consideration for applications of the permanently charged filter in respirators designed to remove toxic particulates and gaseous matter. We have shown in Fig. 16 the efficiency of the permanently charged filters before and after rinsing in a number of different organic solvents. Again, this test is a rather severe test but one that is intended to simulate extreme environments to which the filter will be exposed. When the permanently charged filter is immersed in alkane solvents (hexane, heptane and

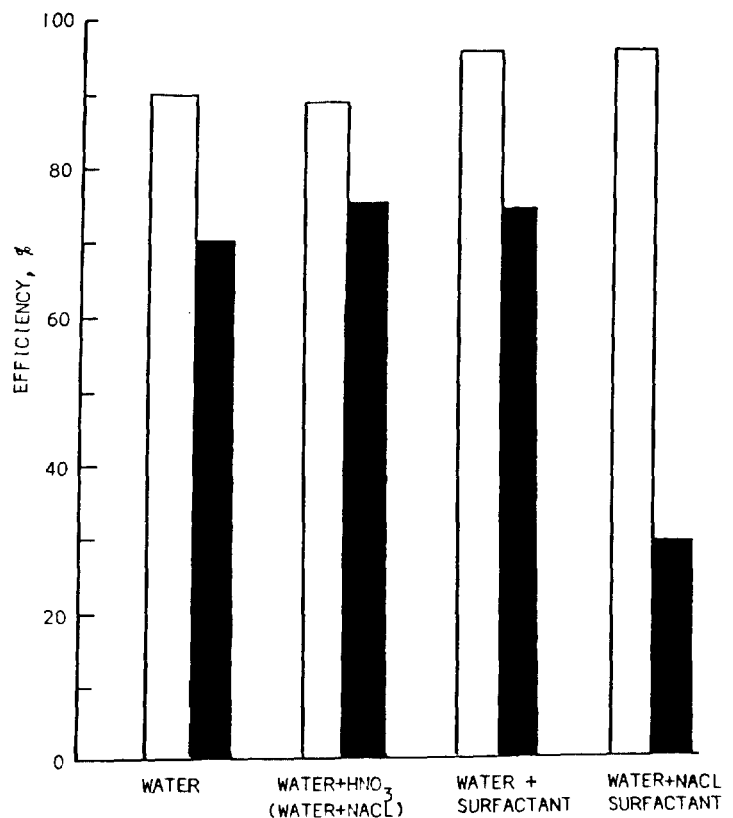

Figure 14. Efficiency of Filtrete 200 g/m<sup>2</sup> before and after immersing in water solutions, NaCl aerosols, U=64 cm/s.



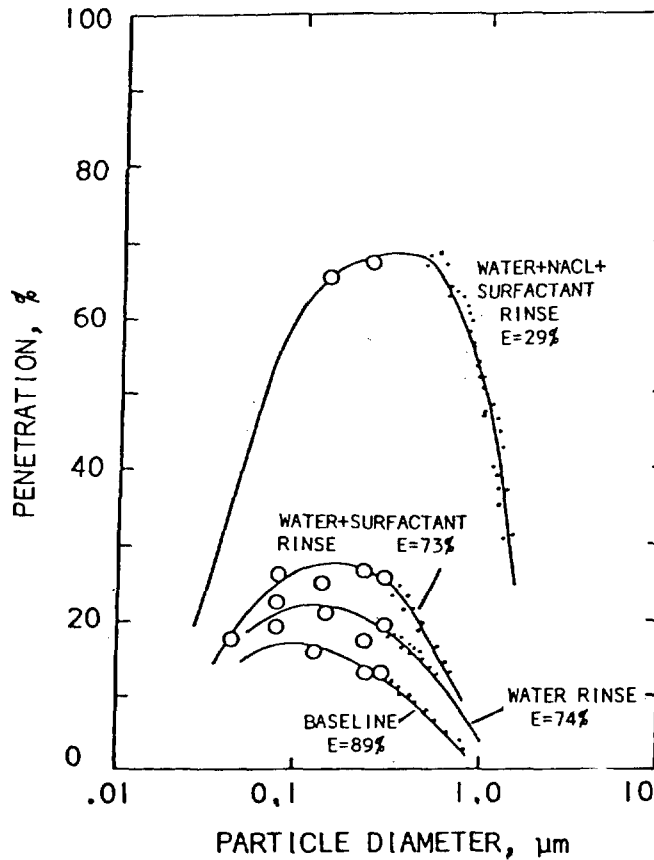

Figure 15. Aerosol penetration of Filtrete 200 g/m<sup>2</sup> after exposure to various water solutions, U=64 cm/s.

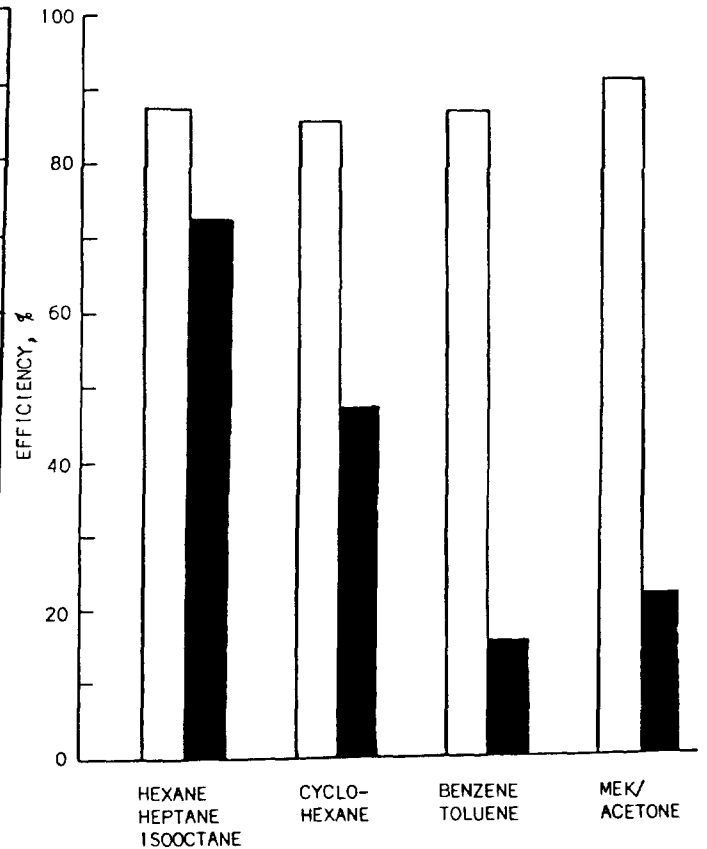

Figure 16. Efficiency of Filtrete 200 g/m<sup>2</sup> after exposure to organic chemical NaCl, U=64 cm/s.

iso-octane) we see a relatively mild deterioration in efficiency. This is very comparable to that seen when immersing in pure water. However, in contrast to the water solutions discussed previously, all of the organic solvents here completely wet the filter surface. When we immerse the filter in a cyclohexane solvent we see a greater decrease in efficiency. After immersion in a benzene or toluene solvent, and a MEK/acetone solution the filter efficiency has dropped to the level of complete neutralization.

Since the exposure of the filter to liquid organic solvents is extreme and unlikely to occur in field applications we examined the effect of exposing the filter to organic vapors. We placed a sheet of Filtrete media, 100g/m<sup>2</sup>, in a sealed container saturated with MEK/acetone vapor for 24 hours. Filter efficiency measurements were made on the filter before and after exposure to the organic vapors using NaCl aerosols and the light scattering photometer. We found that the efficiency at a face velocity of 64 cm/s had dropped from 71% to 49%. Although the decrease in filter efficiency is less with organic vapors than with organic liquids our tests demonstrate that exposure to organics is a major problem with this filter.

We examined the possible mechanism for the decrease in filter efficiency on exposure to organic vapors and solvents. In none of these cases are any ionic species present, so our hypothesis of charge neutralization cannot hold. One possibility that we examined for the behavior shown in Fig. 16 was the

conductivity of the solvents allowed a conductive path around the filter fiber, thereby effectively short circuiting the positive and negative sides. However, this hypothesis was not valid because the conductivities of the respective solvents do not follow the trend of increasing deterioration as seen in Fig. 16. A factor that would explain the increasing deterioration with the respective solvents is the increasing chemical reactivity of the solvents as we go from hexane to cyclohexane to benzene, toluene and MEK/acetone. Therefore, we hypothesize that these solvents are able to react chemically with the surface charge (presumably present on the surface as free radicals or ions). Electron micrographs of these filters after immersion in the solvents showed no discernable difference in morphology due to the solvent action.

For each of the organic solvents, we have also conducted penetration measurements as a function of particle diameter before and after immersion. The aerosol penetration of the filter before and after rinsing in an MEK/acetone solvent is shown in Fig. 17. Again, in addition to the increase in penetration note that the peak penetration after the filter was rinsed in acetone/MEK has shifted to larger particle diameters. This figure shows the dramatic increase in penetration that results when the filter is discharged.

The problem of filter discharging when exposed to organics can be minimized in respirator applications by placing the permanently charged filter after the gas adsorber, which is usually an activated carbon. Organic vapors would then be absorbed in the activated carbon and not reach the filter. The conventional respirator design has the particulate filter ahead of the gas adsorber to prevent fouling the gas adsorber. If fouling of the gas adsorber presents a problem then a conventional fibrous filter will have to precede the gas adsorber.

#### Media Exposure to Anti-Static Agents

Another treatment we have performed on these permanently charged filters is spraying the filter media with an anti-static agent obtained from Sprayway, Inc., Addison, Illinois. We did this in an effort to determine what fraction of the total efficiency is due to electrostatic attraction. Assuming that the anti-static agent is 100% effective in neutralizing all charge on the filter, these tests then allowed us to assess the degree to which the electrification is responsible for the total filter efficiency. As shown in Fig. 18, the electrification is responsible for nearly all of the efficiency. In this case the efficiency measured with a light scattering photometer decreased from 90% before spraying to 10% after spraying with the anti-static agent. We have conducted

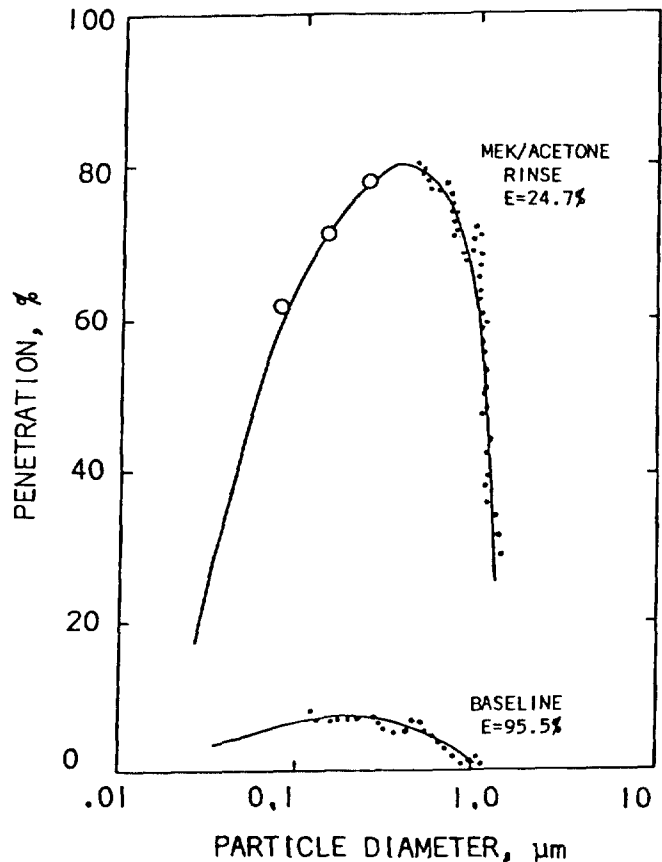

Figure 17. Aerosol penetration of Filtrete 200 g/m<sup>2</sup> after an MEK/acetone rinse, NaCl, U=16 cm/s.

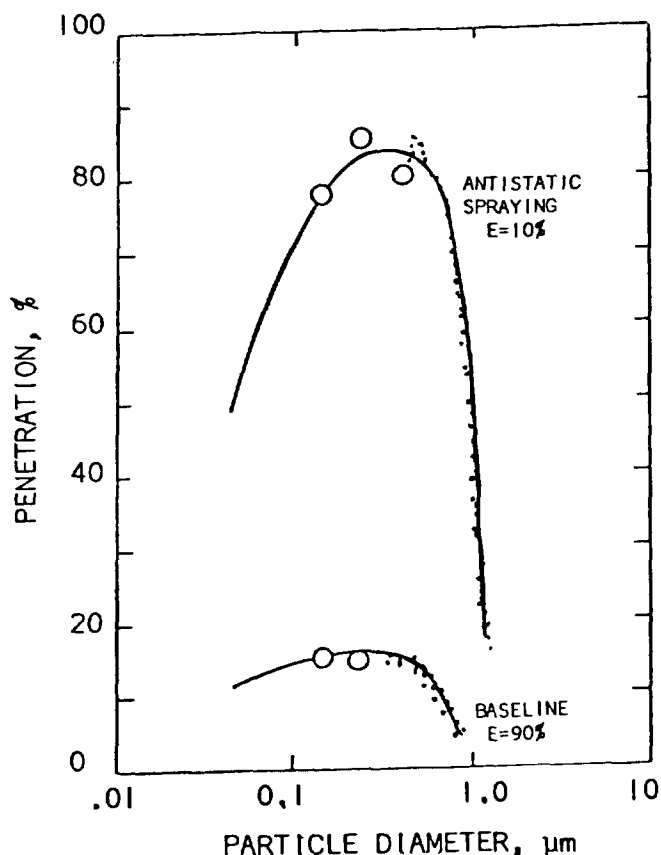

Figure 18. Aerosol penetration of Filtrete 200 g/m<sup>2</sup> before and after antistatic spraying, NaCl, U=64 cm/s.

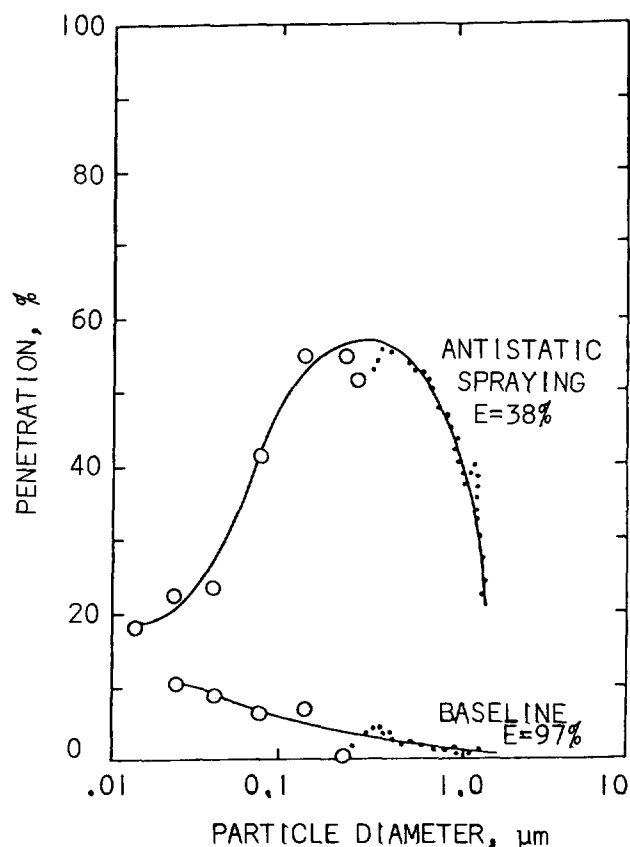

Figure 19. Aerosol penetration of Capofilter before and after antistatic spraying, NaCl, U=64 cm/s.

similar experiments with the other types of permanently charged filters. Figure 19 shows a comparable experiment with a resin wool filter. Note, in this case, that the resin wool filter is able to retain a much higher efficiency after spraying with the anti-static agent which indicates that it has a higher mechanical efficiency than the Filtrete media.

#### Effect of Initial Fiber Charge on Filter Loading

Electric filters have two characteristic advantages over conventional filters: they have higher efficiencies and higher particle loadings.<sup>(2,4,6)</sup> We have already discussed the large increase in filter efficiency due to the electrical effects in permanently charged filters. Previous investigators have shown that electric filters using external electrification by applying high voltage to the media<sup>(2,4,6)</sup> or precharging the aerosols<sup>(15)</sup> will significantly increase the particle loading. Van Turnhout has conducted a preliminary test indicating that permanently charged filters also show an enhanced particle loading compared to uncharged filters.<sup>(16)</sup> In an effort to verify that permanently charged filters exhibit an enhanced particle loading we compared the filter efficiency and pressure drop of charged and discharged filters during particle loading with NaCl and DOS aerosols. The discharged filters were produced by spraying the charged filters with an anti-static agent.

Figure 20 shows the test results on loading charged and discharged Filtrete media with NaCl aerosols. We have previously described the results of the charged Filtrete media in terms of the particle collection mechanism changing from electrical to mechanical as the salt particles neutralize the filter charge during loading. The transition from a predominantly electrical collection to predominantly mechanical collection produces the minimum in the efficiency during the NaCl loading. In contrast, the discharged Filtrete shows a systematic increase in efficiency and pressure drop as NaCl particles load the filter. Note that the efficiency of the discharged filter approaches that of the charged filter at higher particle loadings. This is what would be expected since the collection mechanism for both filters will be dominated at high particle loadings by mechanical capture due to the particle deposits. However, the efficiency of the initially charged filter is still slightly higher than that of the initially discharged filter, which suggests the initially charged filter was not completely neutralized by the NaCl aerosols.

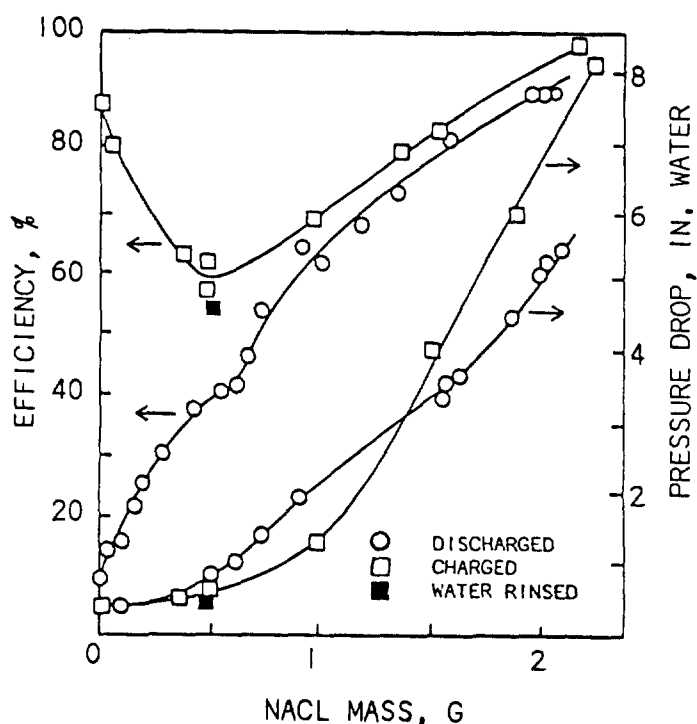

Figure 20. Filter efficiency and pressure drop of charged and discharged Filtrete 200 g/m<sup>2</sup> during loading with NaCl aerosols, U=64 cm/s.

In assessing the effect of the electrical charges on particle loading, it is important to recognize that the charged filter is being neutralized during particle loading which will reduce any enhanced loading effect. Any enhancement of particle loading for the charged filter would be reflected in a lower pressure drop than the discharged filter at a given particle loading. In Fig. 20 we see that the initially charged filter has a lower pressure drop than the discharged filter below 1.4 grams of NaCl while above 1.4 grams of NaCl the pattern is reversed. The reason for the crossover in pressure drop curves is not determined. We believe that this is not a real effect and is actually due to a breaking up of the particle deposits when the filter was removed from the filter holder for weighing. A lower pressure drop results from the broken deposits forming a more open, less restrictive structure. This explanation is supported by the apparent break in the pressure drop curve at the crossover point. Normally, the pressure drop would increase in an exponential fashion with increasing particle loading. Since the dominant collection mechanism switches from electrical to mechanical at 0.5 grams of NaCl, the lack of a significant enhancement of particle loading over the entire loading is not surprising. However, within the loading region where electrical attraction is still significant (below 1.0 grams of NaCl), the charged filter has a measureable loading enhancement over the discharged filter. We should also

## 17th DOE NUCLEAR AIR CLEANING CONFERENCE

explicitly point out what we have implied in our discussion of electrically enhanced particle loading, namely that lower charged aerosols will demonstrate increased particle loading because the charged filter will not be neutralized as rapidly.

After the initially charged filters had been completely loaded with sodium chloride aerosols we rinsed the filters in water in an effort to remove the salt deposits. We were able to remove all of the salt deposits by this method except for 0.5 g sodium chloride. Measuring the efficiency and pressure drop after this rinsing revealed that we had effectively reached the same values that were originally obtained at that particle mass loading. The data, shown in Fig. 20 as solid squares, illustrate that once the dominant mechanism for particle capture of solid aerosols is controlled by the mechanical mechanism, we no longer have a continued deterioration of the filter charge. Beginning at the point of minimum efficiency, the filter will no longer lose additional fiber charge because the newly collected particles will be trapped by previously deposited particles, and will be unable to neutralize the fiber charge. We have been able to verify this hypothesis experimentally by the preceding experiment in which we have washed off most of the salt deposits.

We also measured the aerosol penetration as a function of particle diameter after rinsing off the sodium chloride deposits. Figure 21 shows the aerosol penetration as a function of particle diameter for the loaded filter after washing off most of the salt deposits. A residual salt loading of 0.5 g could not be removed in the wash. We also compared the penetration curves for the clean filter and after it was loaded with 0.5 g NaCl. Note that the penetration curve for the filter with 0.5 g NaCl deposit remaining after washing is nearly identical with the penetration curve for the same filter having 0.5 g NaCl deposited during normal loading. The nearly identical penetration curves show that no further neutralization of the filter charge occurred beyond the minimum filter efficiency at 0.5 g loading.

Comparable filter loading studies were performed using liquid DOS aerosol and are shown in Fig. 22. The efficiency as a function of DOS mass loading for two charged filters is compared to that for a discharged filter. The discharged filter was obtained by spraying a charged filter with an anti-static agent. Both of the charged filters show a continual decrease in efficiency with increasing DOS loading while the discharged filter shows practically no change in efficiency with increasing DOS loading. We do not know why the rate of filter discharging differs for the two charged filters although we believe the difference is due to slight differences in aerosol charge. Note that the pressure drop for all three filters has remained virtually the same as DOS has accumulated on the filters. We would not expect any differences in pressure drop with loading because the liquid DOS uniformly coats the fiber surface after striking the surface.

### Protective Coatings for Minimizing Fiber Charge Neutralization

We have seen that permanently charged filters are subject to deterioration due to actual usage in collecting both solid and liquid aerosols, and by various environmental conditions, such as water solutions with trace contaminants of ions and a wetting agent, as well as exposure to organic solvents. This filter deterioration places severe restrictions on the applications of permanently charged filters and is the primary factor limiting its widespread use. A promising solution to this problem appears to be the application of a protective coating around the charged fibers in an effort to prevent the charge neutralization. We conducted a series of experiments to explore the feasibility of this

concept. The motivation for these experiments was provided by both theoretical investigations and early experiments on annealing electret type materials. Van Turnout<sup>(9)</sup> has found that thermal annealing of permanently charged electret materials would result in a more stable electret and be less susceptible to charge loss. Other researchers have found that the charge on the polymer resides on the polymer surface and at increasing depths within the polymer.<sup>(17)</sup> The charge at the surface is more susceptible to loss and that within the media itself is more resistant to deterioration and loss. In an effort to simulate the thermal annealing process and increase the number of charges deeply imbedded within the polymer media we have investigated various methods for coating the charged polymer surface.

Figure 23 shows the results of some of our experiments. In this figure we compare the efficiency of a Filtrete media before and after rinsing in water after various coating techniques. We have selected the water immersion technique as being representative of a mild charge deterioration. The baseline case, that of no coating treatment, indicates a deterioration of approximately 20% after immersion in water. In the second case, we have vapor deposited a thin layer of paralene coating on the Filtrete fibers. A slight deterioration of the initial efficiency before immersion in water is indicated. This occurs because the electric field is slightly decreased when a dielectric media is placed over a charge. After immersion in water however, the filter does not deteriorate to the same level as we had with no coating. This suggests the paralene coating appears to be effective in reducing the charge loss. In all of our coating techniques we have been unable to uniformly coat all of our filter fibers. In the case of paralene deposition we believe we were only able to coat the front few layers of fibers within the filter media and the bulk of the media remained uncoated.

The next coating technique we examined was immersing the filter in a polymer solution and allowing the solvent to evaporate. In this case, we used a silicone polymer dissolved in heptane. We selected heptane because it produced the least deterioration in filter efficiency of the possible organic solvents. The solution technique for coating the fiber had to address the additional problem of filter charge deterioration due to the solvent alone. This technique for coating the fiber surface appears to be the least promising of all since the most promising solvents for dissolving good polymer coatings are also those solvents

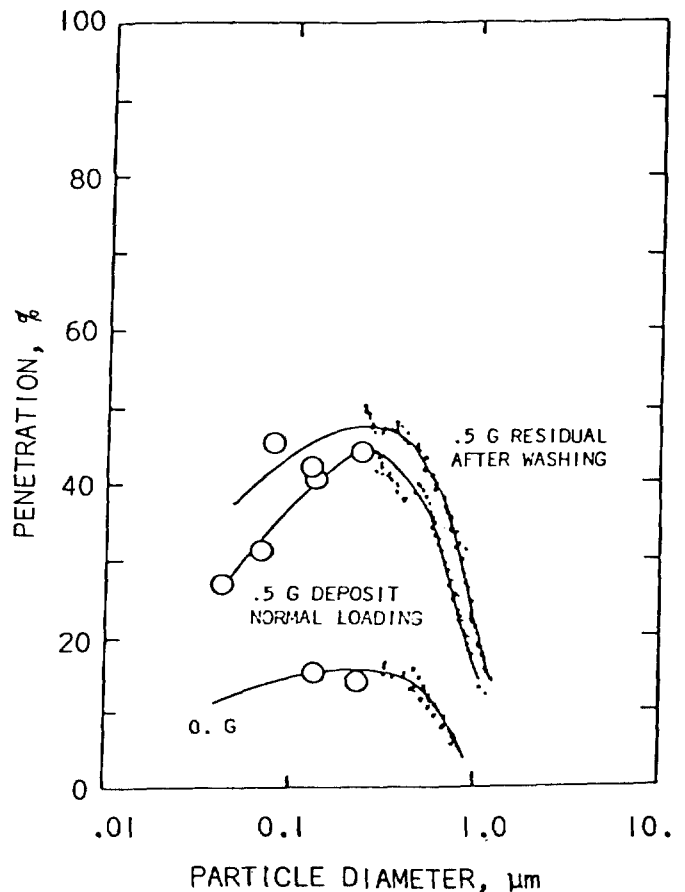

Figure 21. Aerosol penetration of Filtrete 200 g/m<sup>2</sup> having 0.5 gm residual NaCl deposit after washing compared to unloaded Filtrete and Filtrete loaded with 0.5 gm NaCl, U=64 cm/s.

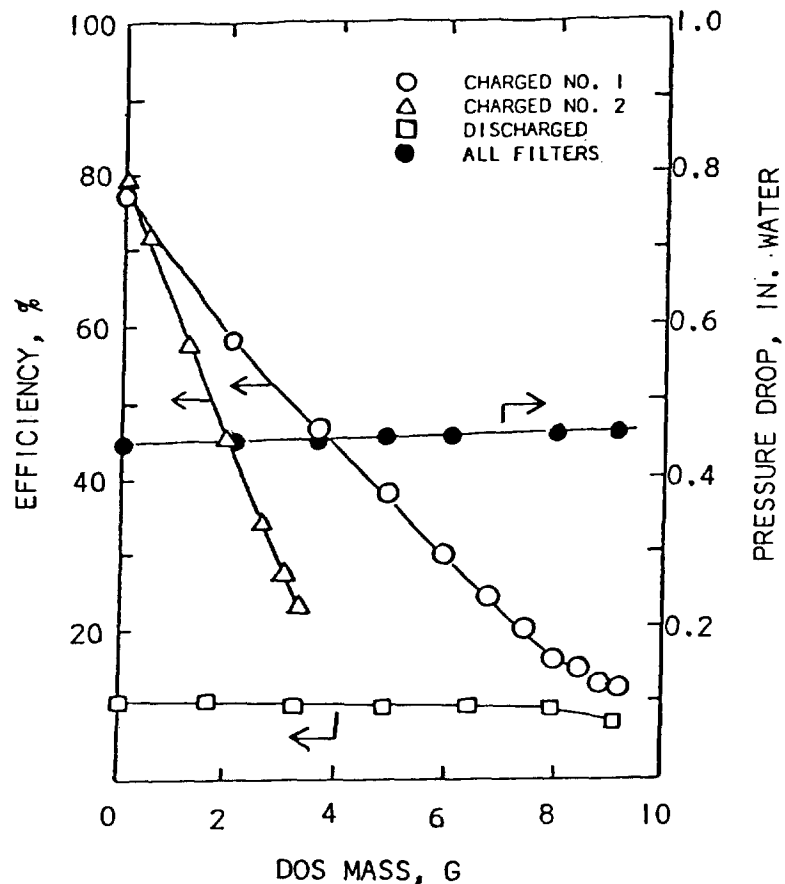

Figure 22. Efficiency and pressure drop of charged and discharged Filtrete 200 g/m<sup>2</sup> during loading with DOS aerosol, U=64 cm/s.

that are very effective in discharging the permanently charged filters. After coating the filter with a silicone in heptane solution we found the filter efficiency had already dropped to such a low efficiency that we did not continue to examine the performance after immersion in water. We found that the silicone on polymerizing had emitted acetic acid which we believe was responsible for the charge deterioration.

The last technique we examined for coating the filter media was using a spray technique. In this case we had used cellulose acetate butyrate (CAB) in a MEK acetone solution and had found dramatically varying results before and after coating. In some cases the spray coating technique had dramatically decreased the efficiency and in others it had a very minor effect when compared to the baseline case. We believe the large decrease in filter efficiency was due to neutralization of the filter charge either by excessive MEK/acetone solvent in the spray, or by an excessive aerosol charge produced in the spraying process. We believe that more dramatic results were not achieved because the spray coating technique was only able to coat the front portion of the filter mat thereby leaving the interior portion uncoated. Applying the coating on the fibers prior to forming them into a filter mat would eliminate the problem with a non-uniform coating through the filter mat.

## 17th DOE NUCLEAR AIR CLEANING CONFERENCE

We then examined the effect of the protective coating on the efficiency of the permanently charged filters during particle mass loading. Fig. 24 shows the efficiency of two Filtrete 200 g/m<sup>2</sup> filters that were spray coated with CAB and an uncoated Filtrete 200 g/m<sup>2</sup> filter as they are loaded with NaCl aerosols. Our baseline case with no protective coating shows that the efficiency rapidly decreases as sodium chloride aerosols are loaded on the filter. Our initial test of the filter with a protective coating (triangles) suggested that the coating was able to prevent the rapid decrease in efficiency. We had surmised that the protective coating was preventing a charge neutralization of the filter by the charged aerosols. Unfortunately, our second experiments (squares) indicated this was not the case and the protective coating had no effect on the efficiency as sodium chloride aerosols were deposited on the fibers. This is seen when comparing the respective curves for the pressure drop as a function of the sodium chloride mass loadings. The pressure drop curve for the first test (triangles), which showed relatively little deterioration in efficiency with sodium chloride loading also had a dramatically higher pressure drop. The resulting higher pressure drop indicates that the mechanical efficiency would also be higher in this filter. Thus, we see from comparing the pressure drops of the filter with the protective coating and the baseline case that the apparent protective effect of the CAB coating is not, in fact, due to any prevention of fiber charge neutralization but rather, strictly due to a higher mechanical efficiency as indicated by the pressure drop. For the two filters in which the initial pressure drop is very comparable we see comparable results in efficiency versus mass loading. Thus, we are faced with a situation that a protective coating, even if successfully applied, will be unable to prevent the decreasing efficiency of the permanently charged filters.

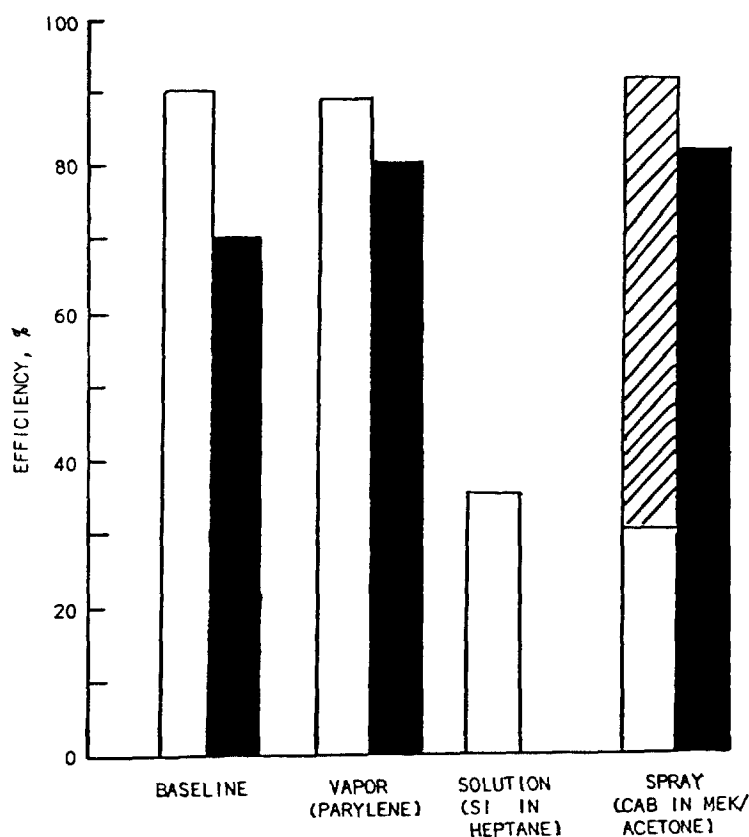

Figure 23. Efficiency of Filtrete 200 g/m<sup>2</sup> before and after various coating applications, NaCl aerosols, U=64 cm/s.



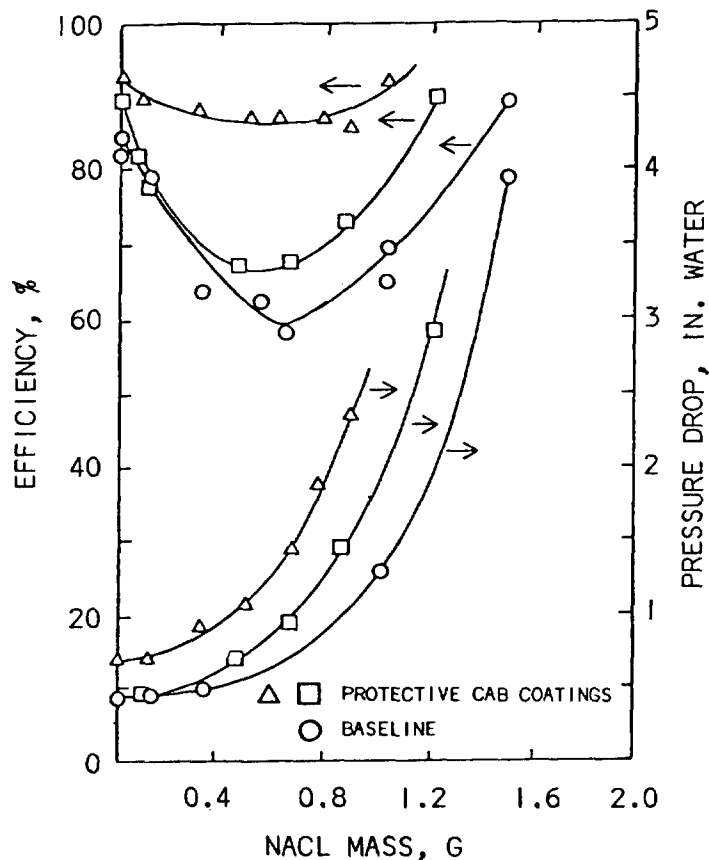

Figure 24. Filter efficiency and pressure drop for a baseline filter 200 g/m<sup>2</sup> and for Filtrete 200 g/m<sup>2</sup> having a spray coating of CAB during loading with NaCl aerosols, U=64 cm/s.

V. Prospects for Preventing the Discharge of Permanently Charged Filter

In glass fibrous filters, a charged particle that deposits on a fiber transfers the charge to the fiber surface. The charge then migrates on the fiber surface to the surrounding filter holder. However, in the case of permanently charged filters, the fibers are fabricated from polymeric materials that have extremely high resistivities or have a highly resistive polymeric powder coating the fiber. Consequently, the charge on the particle that transfers onto the polymeric fiber or powder remains at the location at which the particle initially landed. A theoretical analysis shows that the deposition of charged particles on permanently charged filters will result in neutralization of the filter charge even with a protective coating.

The appropriate theory for analyzing the effect of charged particles on permanently charged filters is Gauss' theorem which is given by Equation 1.

$$\int_s \vec{E} \cdot d\vec{s} = \frac{q_{net}}{\epsilon_0} \tag{1}$$

Where E = electric field, volt/meter  
 s = Gaussian surface, meter squared  
 q<sub>net</sub> = net charge within Gaussian surface, Coulomb  
 ε<sub>0</sub> = electric permittivity, Coulomb/neutron/meter squared

We have illustrated the application of Gauss' theorem to the problem of filter discharging in Fig. 25.

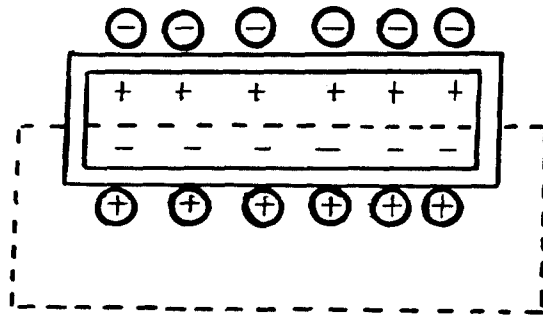

Figure 25. Schematic of the cross section of a Filtrete fiber having a protective coating and a deposit of charged aerosols. The dashed lines represent the Gaussian surface.

According to Gauss's theorem, a closed surface drawn through a section of the filter shows that the electric field emanating from the surface is equal to the net electrical charge within the surface envelope. Thus, as charged particles accumulate on the filter surface and the charge is unable to bleed away, we have a condition where the electrical field gradually decreases with increasing particle accumulation until we have a net cancellation of charge within the Gaussian surface and hence, no electrical

enhancement. The key parameter in this analysis that results in the loss of filter efficiency is the fact that the charge from the particles either neutralizes the fiber charge or is unable to dissipate on the permanently charged filter. Only in the case where the particles are either washed off or the neutralizing agent is removed, as we had seen with our previous experiments with ionic solutions, will an insulating coating be effective in preventing filter deterioration. With this exception we must conclude that permanently charged filters will lose their electrical enhancement either due to a direct neutralization of the fiber charge or by a cancellation of the net fiber charge as the filter becomes loaded with aerosols.

## VI. Conclusions

We have shown that permanently charged filters have much higher efficiencies than uncharged filters but they suffer from a loss of electrical enhancement due to the filter discharging. We have identified three mechanisms for the loss of fiber charge; (a) direct neutralization of fiber charge by charged aerosols or ions, (b) chemical reaction of organic solvents with the charges on the polymer surface which are presumably free radicals or ions, and (c) cancellation of the net fiber charge by the close proximity of opposite charges. The problem of filter discharging is inherent to permanently charged filters as presently designed and will limit the widespread use of these filters. Since the filter discharging problem is due to charged aerosols or reactive chemicals, field applications will have to avoid these agents. Thus, permanently charged filters will be ideally suited for filtering neutral or low charged aerosols as may occur in filtering atmospheric aerosols in building ventilation systems. These filters will not perform well in controlling particulate emissions from various industrial processes since the aerosols are generally highly charged.

## VII. Acknowledgements

We are grateful to Mr. A. W. Casey of LLNL for taking the electron micrographic pictures in this report, and Professor F. Loeffler of the University of Karlsruhe, Germany for providing samples of the Freudenberg filters.

## 17th DOE NUCLEAR AIR CLEANING CONFERENCE

### References

1. Nelson, G. O., Richards, C. P., Biermann, A. H., Taylor, R. D., and Miller, H. H., "Air filtration enhancement using electronic techniques," in Proceedings of the Fourteenth ERDA Air Cleaning Conference, Sun Valley, Idaho. August 2-4, CONF-760822, NTIS, Springfield, VA. pp 602-611 (1979).
2. Bergman, W., Taylor, R. D., Miller, H. H., Biermann, A. H., Hebard, H. D., da Roza, R. A., and Lum, B. Y., "Enhanced filtration program at LLL - a progress report," in Proceedings of the Fifteenth DOE Air Cleaning Conference, Boston, MA. August 7-10, 1978. CONF-780819, NTIS, Springfield, VA. pp 1058-1098 (1979).
3. Nelson, G. O., Bergman, W., Miller, H. H., Taylor, R. D., Richards, C. P., and Biermann, A. H., "Enhancement of air filtration using electric fields," Am. Ind. Hyg. Assoc. J., 39 pp. 472-479 (1978).
4. Bergman, W., Hebard, H., Taylor, R., and Lum, B., "Electrostatic filters generated by electric fields," in Proceedings of the Second World Filtration Congress, September 18-20, 1979. London, England, Uplands Press Ltd., 1 Katharine Street, Croydon CR9 1LB, England, unpagged, (1979).
5. Bergman, W., Taylor, R. D., Hebard, H. D., Lum, B. Y., Kuhl, W. D., Boling, R. M., and Buttedahl, O. I., "Electrofibrous prefilters for use in the nuclear industry," in Proceedings of the Second U.S. DOE Environmental Control symposium, Reston, VA. March 17-19, 1980. CONF-800334/2, NTIS, Springfield, VA. pp. 334-371, (1980).
6. Bergman, W., Biermann, A. H., Hebard, H. D., Lum, B. Y., and Kuhl, W. D., "Electrostatic air filters generated by electric fields," in Proceedings of the Fire Particle-Society Fall Meeting 1980, September 16-18, 1980. College Park, Maryland, Hemisphere Publishing Co., Washington, D. C. in print.
7. Bergman, W., Kuhl, W. D., Russell, W. L., Taylor, R. D., Hebard, H. D., Biermann, A. H., Alvares, N. J., Beason, D. G., and Lum, B. Y., "Electrofibrous prefilters for use in nuclear ventilation systems," in Proceedings of the Sixteenth DOE Nuclear Air Cleaning Conference, October 20-23, 1980. San Diego, CA. CONF-801038, NTIS, Springfield, VA. pp 807-836 (1981).
8. Felthan, F. J., "The Hansen filter," Filtration & Separators, 16 pp. 370-372 (1979).
9. Van Turnhout, J., "The use of polymers for electrets," J. of Electrostatics, 1, pp. 147-163 (1975).
10. Van Turnhout, J., Albers, J.H.M., Adamse, J.W.C., Hoeneveld, W.J., and Visscher, J., "Electret filters for high-efficiency air cleaning," in Proceedings of the Second World Filtration Congress, September 18-20, 1979. London, England, Uplands Press Ltd., 1 Katharine Street, Croydon, CR9 1LB, England, pp 521-528 (1979).
11. Davies, C.N., Air Filtration, Academic Press, London, pp 106-110, (1973).

## 17th DOE NUCLEAR AIR CLEANING CONFERENCE

12. Brown, R.C., "Electrical effects in dust filters," in Proceedings of the Second World Filtration Congress, September 18-20, 1979. London, England. Uplands Press Ltd, 1 Katharine Street, Croydon, CR9 1LB, England, pp 291-301.
13. Knutson, E.D. and Whitby, K.T., "Accurate measurement of aerosol electric mobility moments," J. Aerosol Sci. 6, pp. 453-460 (1975).
14. Instruction Manual for Model 3071, Electrostatic Classifier, Thermal Systems Inc., St. Paul, MN, March 1977.
15. Helfrich, D.J., "Electrostatic filtration and the apitron-design and field performance," in Novel Concepts, Methods and Advanced Technology in Particulate Gas Separation, T. Ariman, Editor, University of Notre Dame Press (1978).
16. Van Turnhout, J., private communication, February 1980.
17. Sessler, G.M. and Von Seggern, H., "Charge distribution and transport in polymers," Charge Storage, Charge Transport and Electrostatics with Their Applications pp 103-105, Y. Wada, M.M. Perlmand and H. Kokado, Editors, Elsevier Scientific Publishing Company, New York (1979).

EVALUATION OF PROTOTYPE ELECTROFIBROUS FILTERS FOR  
NUCLEAR VENTILATION DUCTS\*

W. Bergman, W. D. Kuhl, A. H. Biermann, J. S. Johnson and B. Y. Lum  
Lawrence Livermore National Laboratory  
Livermore, California 94550

ABSTRACT

Two prototype electrofibrous filters were designed, built and evaluated in laboratory tests and in field installations. These prototypes were designed for use in nuclear ventilation ducts as prefilters to HEPA filters. One prototype is designed to be a permanent component of the ventilation system while the other is a disposable unit. The disposable electrofibrous prefilter was installed in the exhaust stream of a glove box in which barrels of uranium turnings are burned. Preliminary tests show the disposable prefilter is effectively prolonging the HEPA filter life.

---

\*This work was performed under the auspices of the U. S. Department of Energy by Lawrence Livermore National Laboratory under contract No. W-7405-ENG-48.

I. Introduction

This report describes the evaluation of two prototype electrofibrous filters for use as prefilters in nuclear ventilation ducts. The designs of these prototypes were obtained by optimizing a number of parameters that determine the performance of the electrofibrous filter. We have conducted extensive theoretical and laboratory investigations to provide the foundation for designing electrofibrous filters for a given application.<sup>(1-4)</sup> The design parameters and criteria for building electrofibrous filters have been presented in another report.<sup>(5)</sup>

Before discussing the specific prototypes presented in this report we will review the fundamental design on which these electrofibrous filters are based and the two characteristic features of these filters. Figure 1 shows the basic components of the electrofibrous filter. A fibrous filter medium is sandwiched between two perforated electrodes separated by a spacer. By applying high voltage to one electrode and grounding the other, an electric field is generated across the filter medium that polarized the filter fibers. All of the prototype filters described in this report have the same basic components.

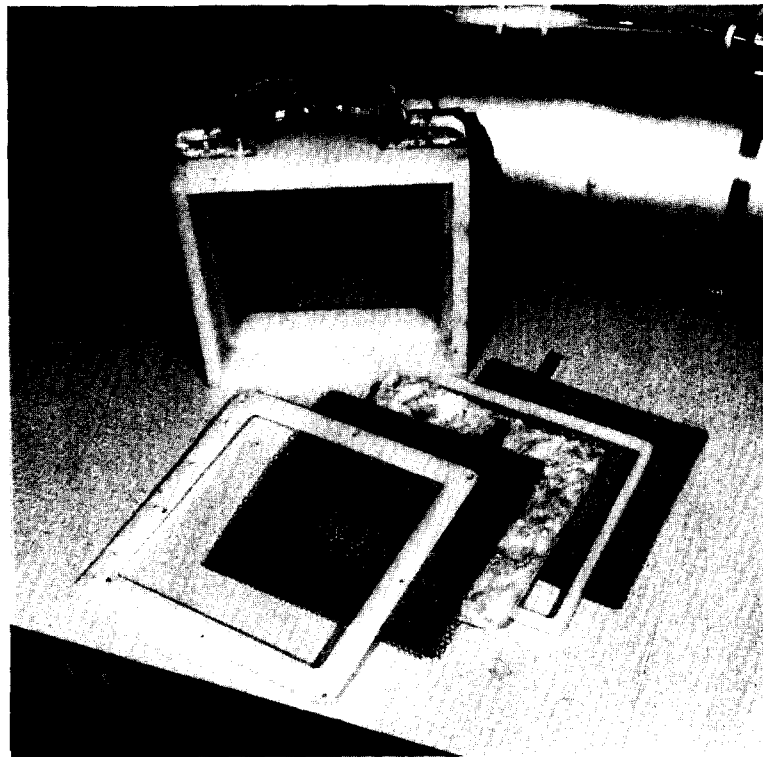

Figure 1. Components of electrofibrous filter.

## 17th DOE NUCLEAR AIR CLEANING CONFERENCE

The two characteristic features that result from this basic design are (1) a higher filter efficiency and (2) an increased particle loading when compared to the unelectrified filter medium. Figure 2 shows that electrifying the filter medium will increase the filter efficiency over all particle sizes. The increase is especially pronounced over the particle size range in which the unelectrified medium shows a minimum efficiency. The increased particle loading that occurs when a filter medium is electrified is shown in Fig. 3. We have previously shown that the increased particle loading is due to changes in the particle deposits caused by the electrical forces. (1,3,4,5)

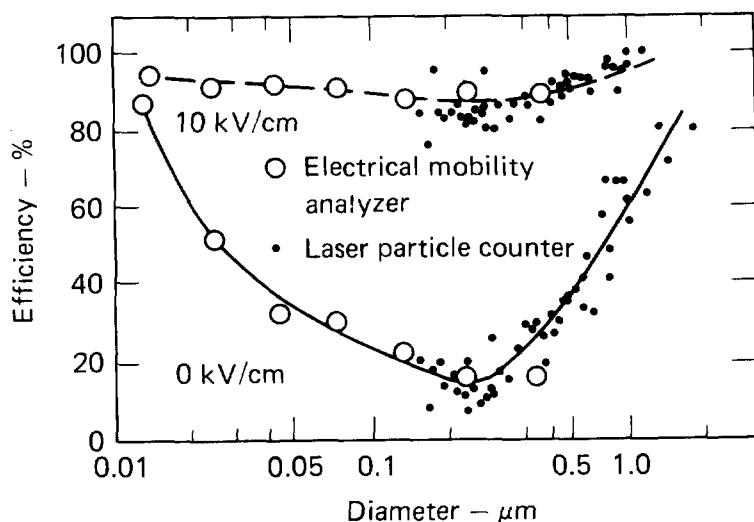

Figure 2. Filter efficiency as a function of particle size with and without an electric field.

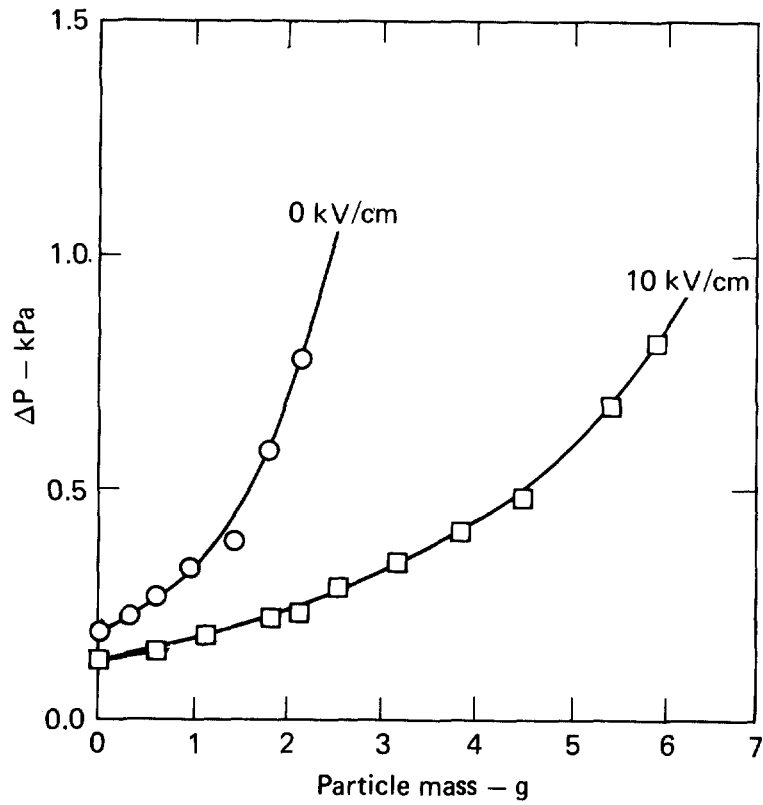

Figure 3. Electrifying a filter medium increases its particle loading capacity.



## 17th DOE NUCLEAR AIR CLEANING CONFERENCE

We have designed two prototype electrofibrous filters for use in nuclear ventilation systems as prefilters for HEPA filters. Both prototypes have the overall dimensions of a standard HEPA filter (2' x 2' x 1') and have the filter media pleated to increase the filtering area. These prefilters are designed to significantly extend the life of the downstream HEPA filters and reduce the overall costs and radioactive waste of the prefilter-HEPA filter system.

However, since the cost for filter replacement is a major fraction of the overall filtration cost in a nuclear facility, the use of a prefilter, whether conventional design or electrified, is cost effective only when the replacement cost for the prefilter is much lower than that for the HEPA filter. If the replacement of a prefilter requires a comparable amount of work as replacing a HEPA filter, the use of a prefilter will not be cost effective.

The housing in which the prefilter is installed must have provisions for easily replacing or cleaning the prefilter. Unfortunately, filter housings for prefilters have historically had the same basic design as used for HEPA filters. Therefore, replacing a prefilter in these housings required about the same effort as replacing a HEPA filter. It is, therefore, not surprising that prefilters have not been widely used in nuclear ventilation systems.

### II. Stationary Electrofibrous Prefilter Designs

We recognized the importance of a properly designed prefilter housing and have designed our electrofibrous prefilters and filter housing as an integrated prefiltration system having minimal maintenance. We have designed and built two different models that represent the two extremes of the basic design in which electrified media is pleated to increase the filtering area.

Figure 4 shows one of our stationary prefilter models mounted inside a ventilation housing that was designed for minimizing prefiltration maintenance. To increase the flexibility of our evaluation program, we have built two separate filter housings into a single unit and have joined the inlet and exhaust openings into a common duct. This ventilation system permits us considerable flexibility in our field evaluations. We can simultaneously evaluate two prefilters or a prefilter and HEPA filter under the same conditions and divert the air flow from one chamber to the other. The primary features of the ventilation housing in Fig. 4 are the glove ports and entry-exit ports which permit prefilter replacement or cleaning without disrupting the ventilation flow. We have essentially built a glove box around the prefilter to allow in-situ maintenance on the prefilter.

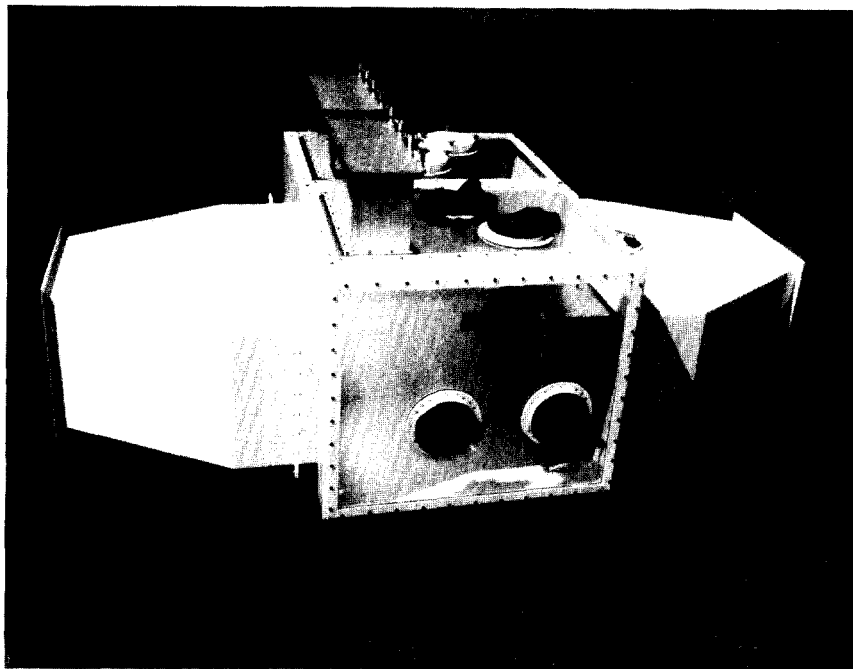

Figure 4. Stationary electrofibrous prefilter mounted inside a low maintenance ventilation housing.

One model of our stationary electrofibrous prefilter is designed to be a permanent component of the ventilation system. It has a rigid stainless steel frame and durable high voltage and ground electrodes. This prefilter design, shown in Fig. 5, uses an inexpensive filter medium that is inserted into the filter unit and removed when it becomes plugged. The filter medium is sandwiched between high voltage and ground electrodes that are pleated to increase the filtering surface area. The front ground electrodes can be pulled out of the filter unit to provide access to the filter medium. Our previous design that was described in reference 5 required an operator to support the front electrode as it was pulled out of the filter unit. That design proved to be impractical because the electrode was heavy and bulky, thereby making the filter medium replacement an awkward and complicated operation. We have significantly improved the filter medium replacement operation by mounting the front electrode on slides that support the electrode as it is pulled out of the filter unit. We have designated this stationary electrofibrous prefilter as our permanent filter model.

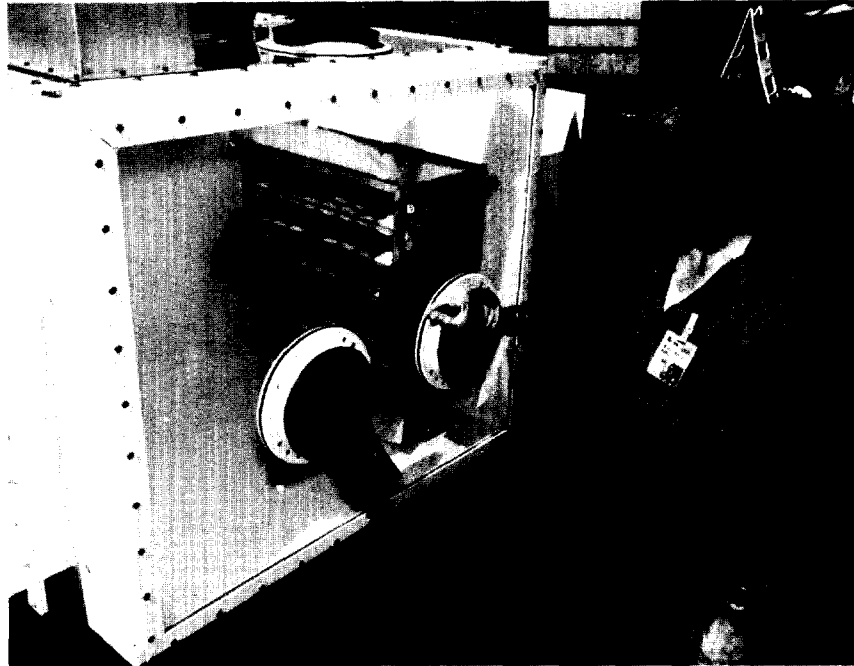

Figure 5. Stationary electrofibrous prefilter designed as a permanent component of the ventilation system.

The operation of replacing the filter medium in our permanent filter model is illustrated in the following sequence of photographs. Figures 6 and 7 show an operator pulling the front electrode away from the filter unit until it clears the filter unit. The front electrode is then rotated in Fig. 8 to permit the filter medium to be slipped over the pleated electrode as shown in Fig. 9. Note that the filter medium is preformed to fit over the front electrode. After the filter medium is slipped over the front electrode, the front electrode is rotated back into its normal position and pushed into the main filter unit as shown in Fig. 10. Filter media is passed into the filter housing through the exit-entry ports as shown in Figs. 11 and 12. The primary operating feature of the permanent filter design is the use of an inexpensive, disposable filter medium in a permanent electrofibrous filter unit.

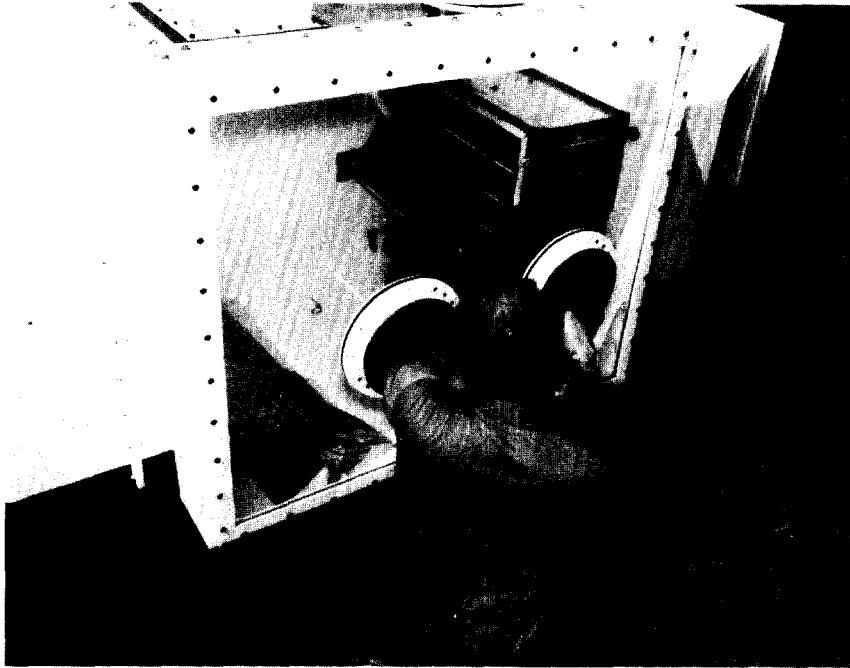

Figure 6. Operator pulling front electrode out of filter unit.

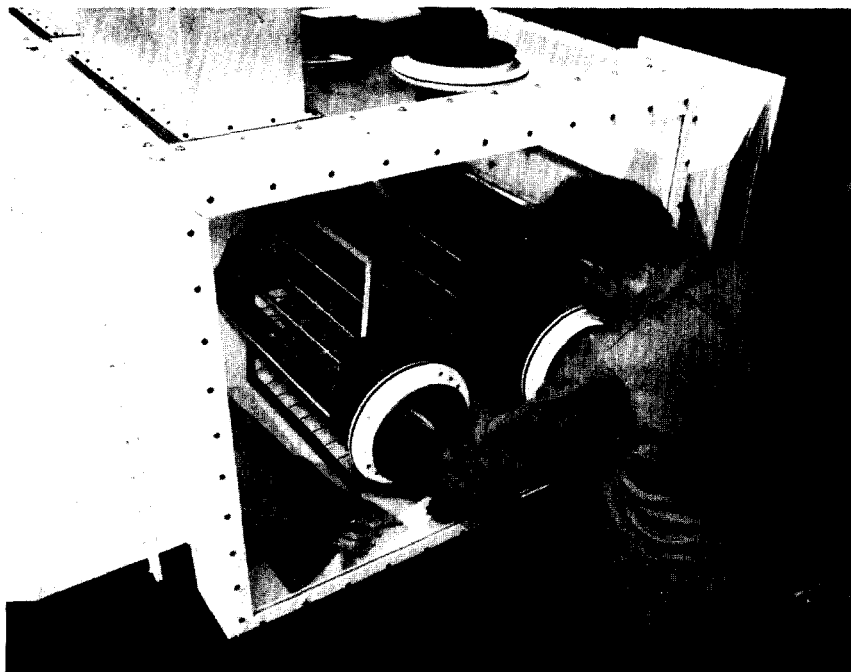

Figure 7. Front electrode pulled out of filter unit.

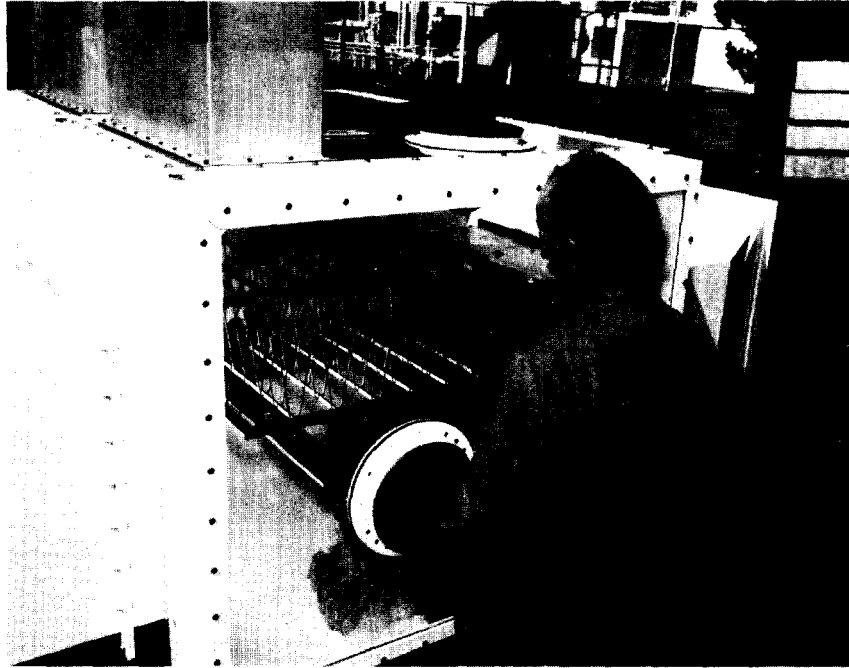

Figure 8. Front electrode rotated for inserting filter medium.

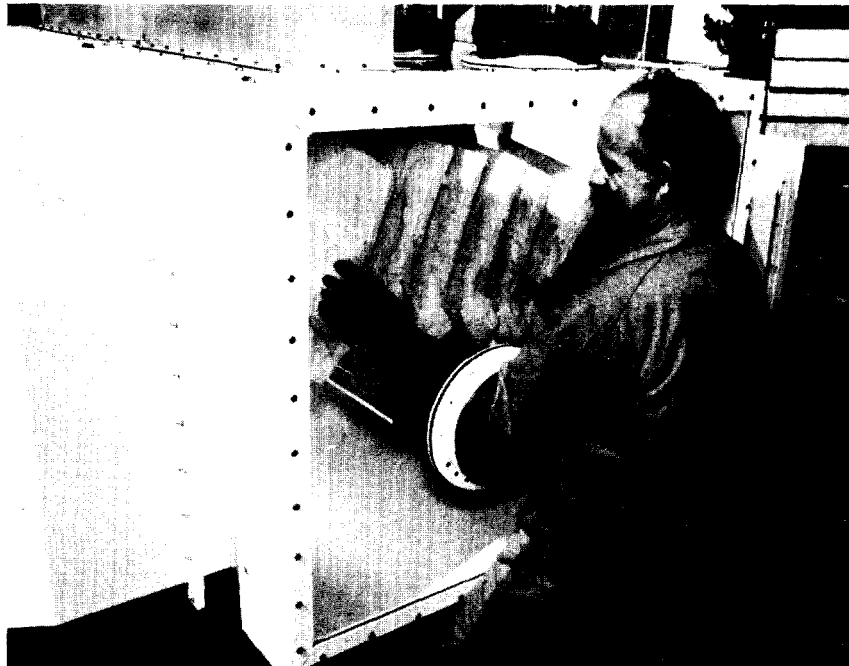

Figure 9. Operator inserting filter medium over front electrode.

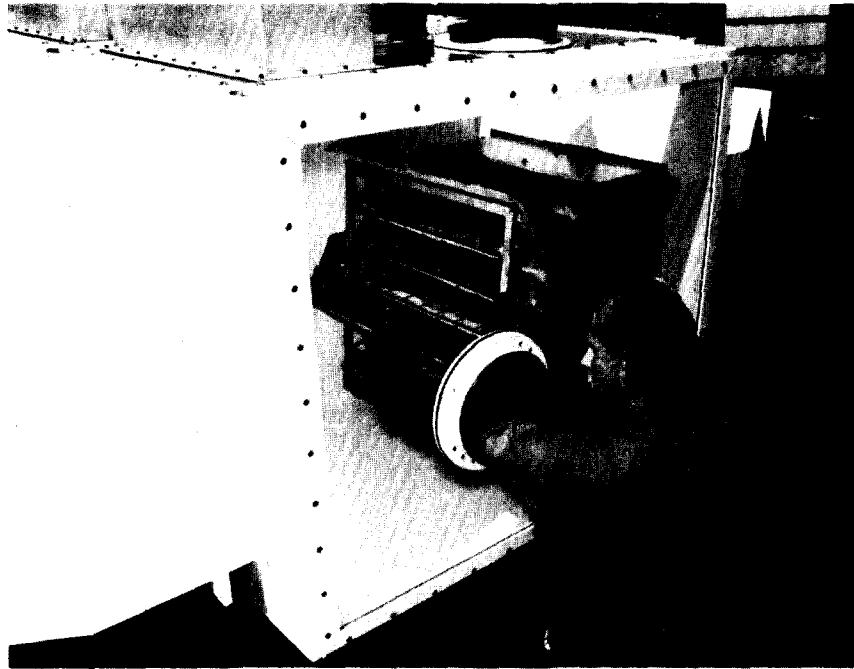

Figure 10. Front electrode with fresh filter medium being pushed into the filter unit.

The second model of our stationary electrofibrous prefilter design is a disposable filter unit that consists of a sealing edge, a pleated filter medium and high voltage and ground electrodes as an integrated unit. Figures 13 and 14 show the inlet and exit sides of the disposable electrofibrous prefilter respectively. The high voltage and ground electrodes are glued on the pleated filter medium and the filter medium glued to the square sealing frame. The electrodes were cut from a flexible stainless steel screen. To prevent short circuiting between the high voltage and ground electrodes at the sewn edges of the filter media, we used rectangular screen segments rather than a continuous strip. The screen segments were cut to maintain a 1.5 inch border around the perimeter of each pleat. The ground electrode segments shown in Fig. 14 were electrically connected to the sealing frame by means of a flexible cable. Figure 13 shows an electrode bus that connects the high voltage electrodes to a common lead. Note that high voltage is applied to the interior electrodes to prevent short circuiting with the ventilation duct in case of accidental misuse or improper installation.

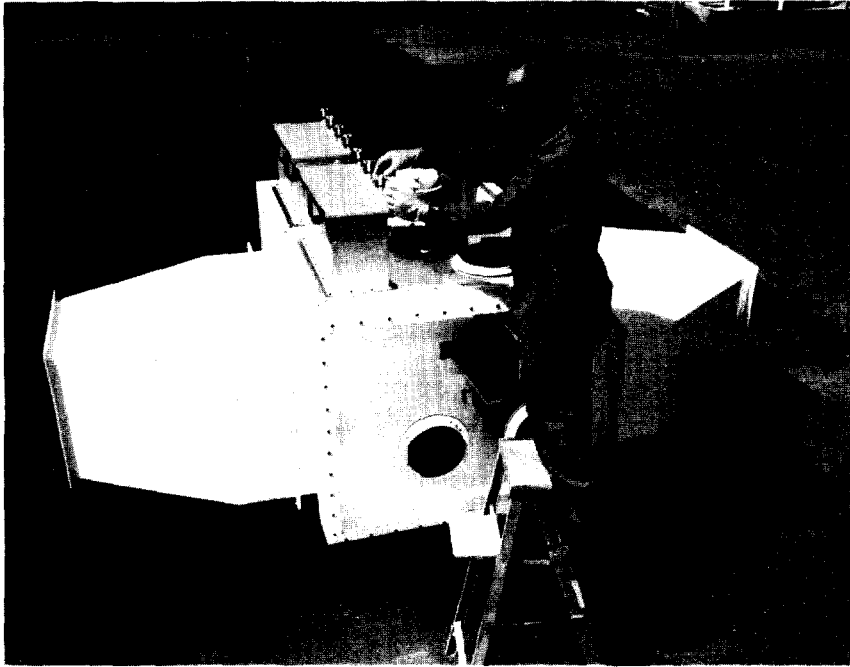

Figure 11. Operator inserting a fresh filter medium into the entry-exit port.

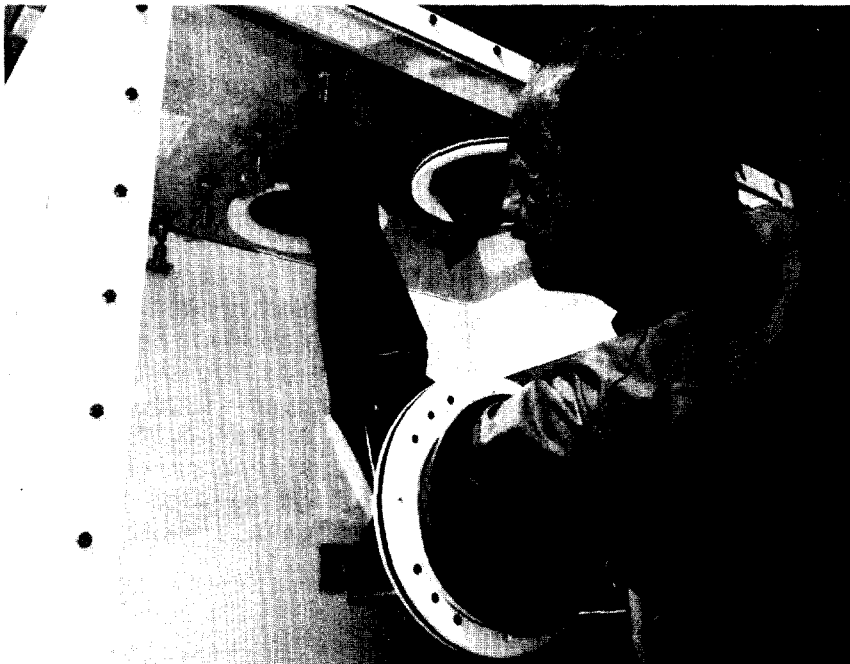

Figure 12. Operator opening the entry-exit port to bring a fresh filter medium into the ventilation housing.

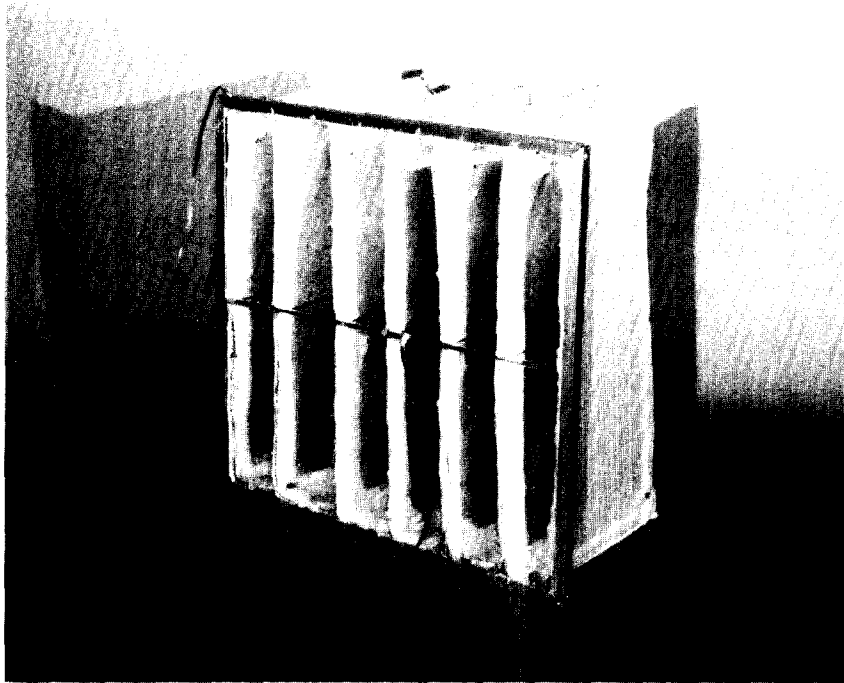

Figure 13. Disposable electrofibrous prefilter showing the inlet side.

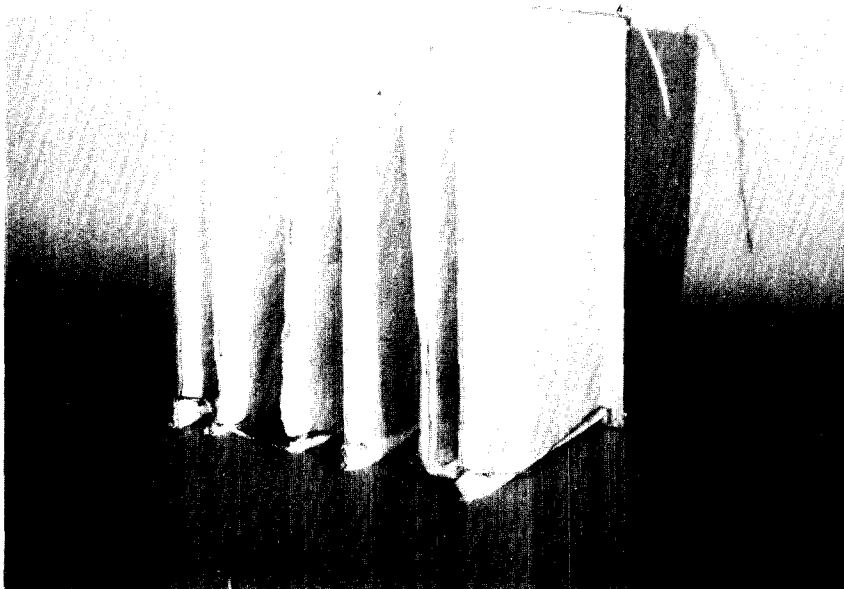

Figure 14. Disposable electrofibrous prefilter showing the exit side.



## 17th DOE NUCLEAR AIR CLEANING CONFERENCE

Since the electrodes and sealing frame are permanently glued to the filter medium, when the filter medium becomes plugged the entire electrofibrous filter must be replaced, hence its designation as a disposable prefilter. Figures 15 and 16 show the disposable prefilter being mounted in the filter housing. The disposable prefilter was mounted on a transparent plastic frame in Figs. 15 and 16 to allow visual inspection of the installed prefilter. In field applications the sealing frame of the disposable filter would be mounted flush against a flange on the ventilation duct.

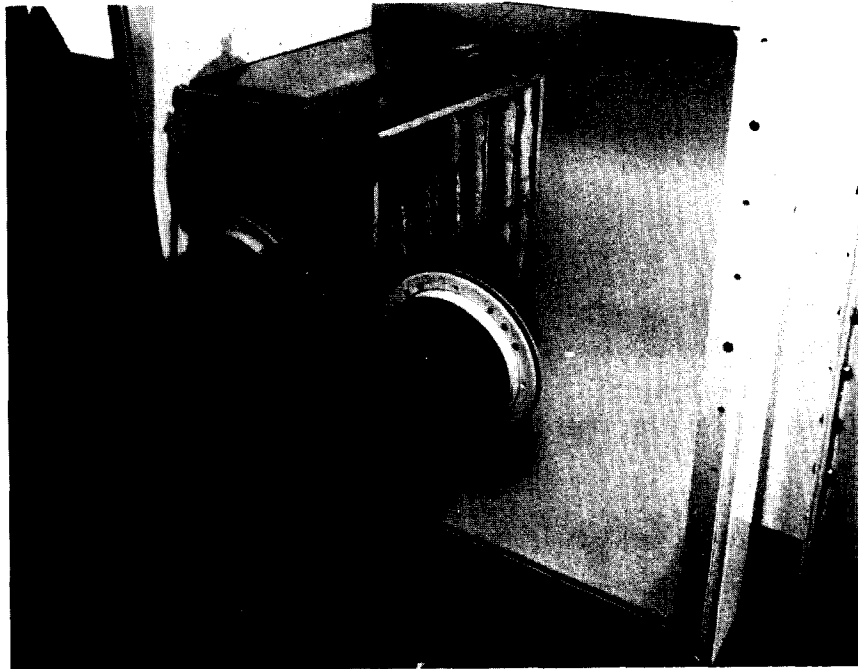

Figure 15. Disposable electrofibrous prefilter being mounted in the filter housing.

The replacement of the disposable filter is easier in some respects and more difficult in others when compared to replacing the filter medium in the permanent filter model. Mounting the disposable filter on the sealing flange of a ventilation duct is much easier than replacing the filter medium in the permanent filter model. However, since the disposable filter has a rigid frame and integral electrodes, the disposable filter is more bulky and hence more difficult to pass through the entry-exit ports when compared to the filter medium for the permanent filter.

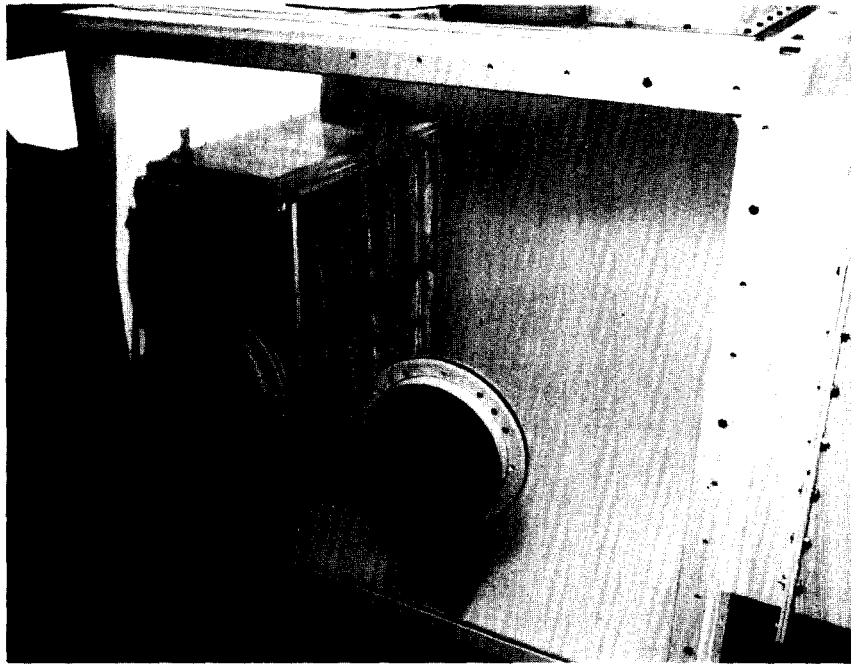

Figure 16. Disposable electrofibrous prefilter mounted in the filter housing.

Both stationary electrofibrous prefilter designs use the same high voltage power supply shown in Fig. 17. We designed the high voltage power supply to convert 100 volt AC input to 10 kV DC output. Figure 18 shows the top view of the power supply with the cover removed. The major component in this unit is a solid state power supply obtained from Spellman. It is shown as the rectangular box in the lower right hand corner. Since the power supply cannot exceed 70  $\mu$ A output current at 10 kV, the unit poses no hazard from electrical shock. One can touch the high voltage output and not feel the electrical discharge. The power supply shown in Fig. 17 has separate push button switches to energize the unit and to supply high voltage output. The high voltage switch also resets the high voltage output if the power supply was overloaded; i.e., if the load on the power supply exceeded 70  $\mu$ A. Indicator lights on the front panel show if the high voltage is on or off.

We designed and built two different models of the stationary electrofibrous prefilter to accommodate the wide range of applications anticipated in the nuclear industry. The primary factor controlling the model to be used is the frequency of filter changes. The permanent filter model would be used in applications requiring a frequent replacement of HEPA filters, while the disposable filter model would be used in applications where HEPA filters are changed less frequently. Applications where the HEPA filter is rarely changed would, of course, not benefit from any prefilter. Figure 19 illustrates how the frequency of changing HEPA filters affects the total filtration cost of the permanent and disposable filter models. The disposable

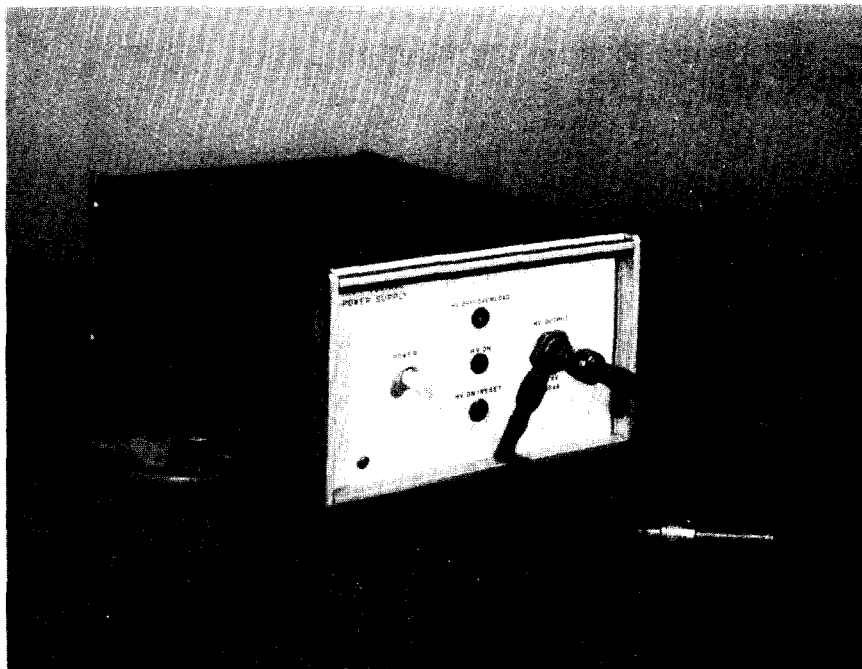

Figure 17. High voltage power supply.

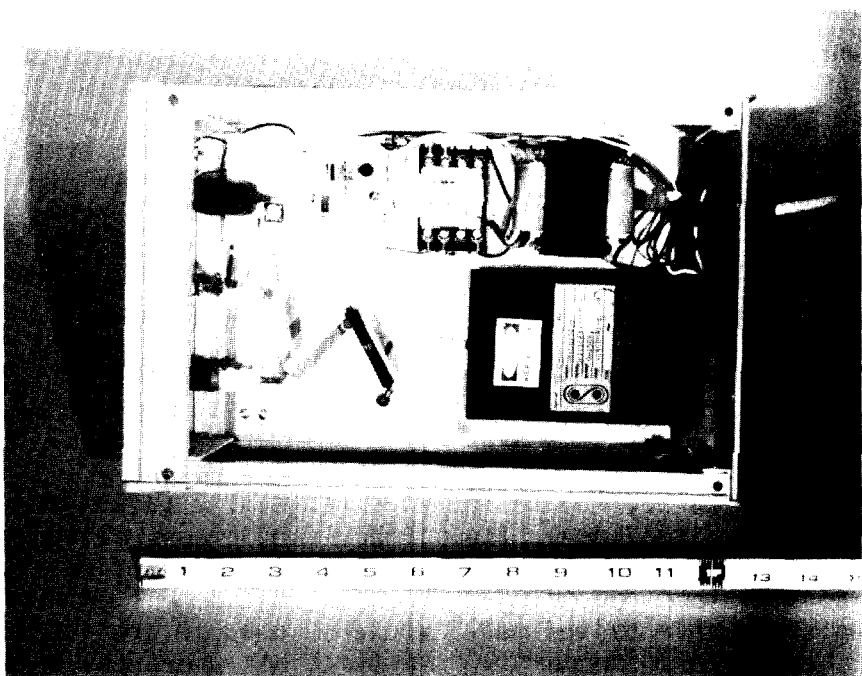

Figure 18. High voltage power supply with top cover removed.

## 17th DOE NUCLEAR AIR CLEANING CONFERENCE

electrofibrous prefilter has a low fixed cost due to the high voltage power supply, but a high operating cost since the entire filter is replaced. In contrast, the permanent electrofibrous prefilter has a high fixed cost due to high voltage power supply plus the permanent filter, but a low operating cost since only the inexpensive filter medium is replaced. Figure 19 shows that the disposable filter model will result in lower filtration costs than the permanent filter model in applications where HEPA filters are changed less frequently. The opposite conclusion is reached in applications where HEPA filters are frequently changed.

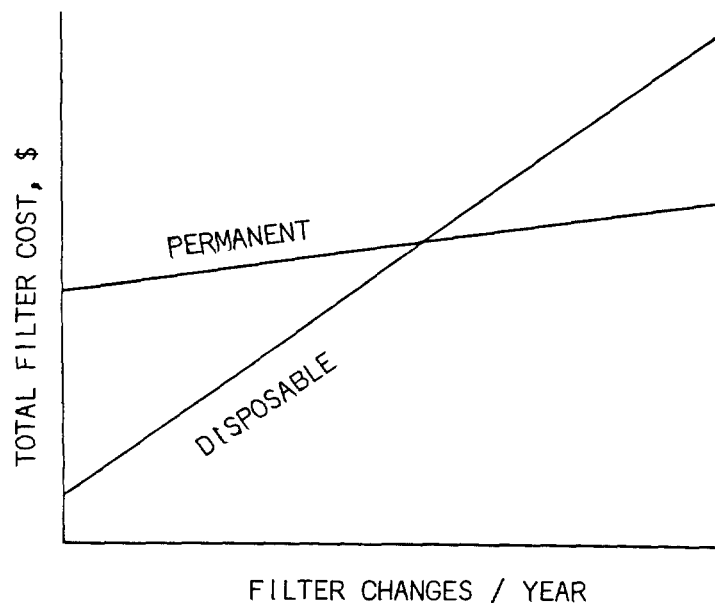

Figure 19. Total filtration costs as a function of filter changes per year for the permanent and disposable filter models.

### III. Laboratory Evaluation of Stationary Electrofibrous Prefilter

We conducted a laboratory evaluation of the disposable prefilter design in our large-scale filter test facility shown in Fig. 20. This facility allows us to evaluate the performance of prototype filters under controlled laboratory conditions at flow rates up to 1300 cfm. Figure 21 shows the filter efficiency of the disposable prefilter design as a function of applied voltage at two air flow rates. The filter efficiencies were determined using sodium chloride aerosols generated with a Wright nebulizer and measured with a light scattering photometer. The NaCl aerosols have an aerodynamic mass medium diameter of  $0.8 \mu\text{m}$  with a  $\sigma_g = 2.0$ . Figure 21 shows that the filter efficiency increases significantly with increasing voltage at both flow rates, although the lower flow rate shows the greater increase.

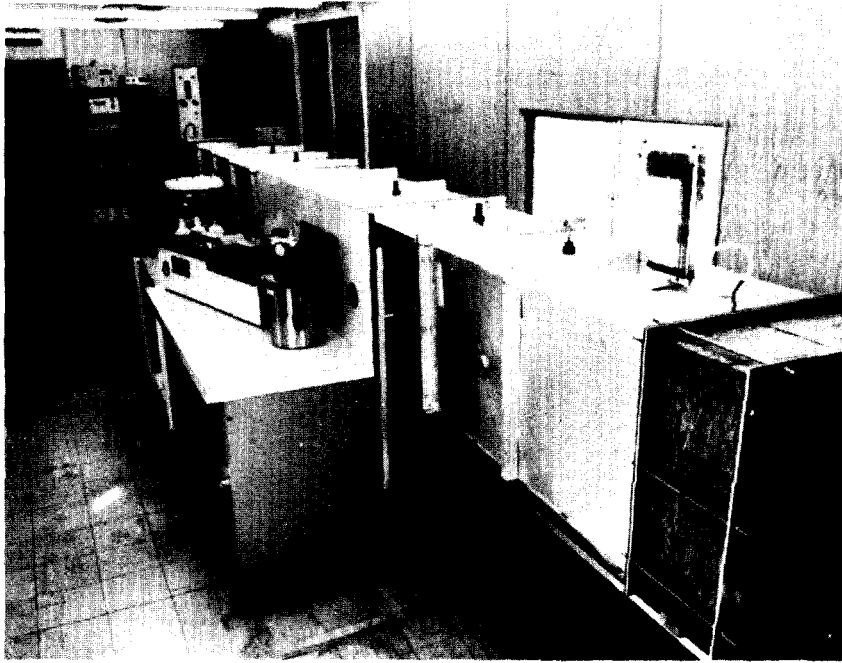

Figure 20. Large-scale filter test facility.

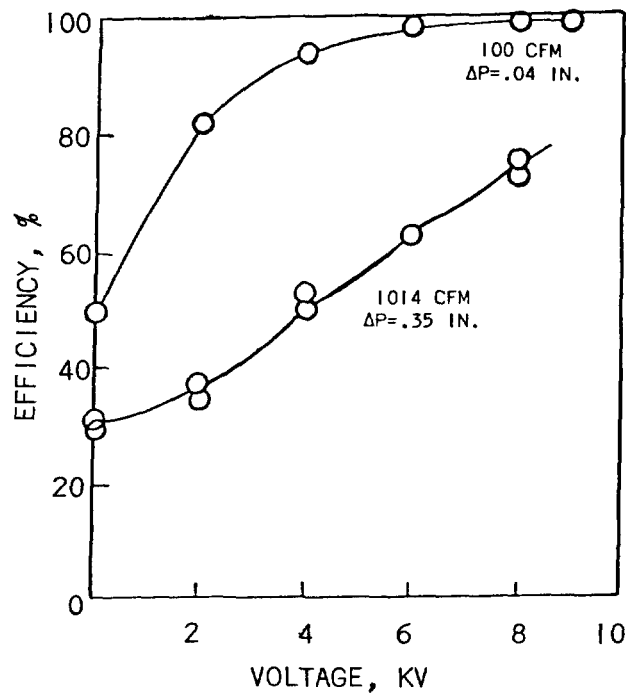

Figure 21. Efficiency of disposable filter as a function of applied voltage at 100 and 104 cfm.

## 17th DOE NUCLEAR AIR CLEANING CONFERENCE

The effect of air flow on filter efficiency and pressure drop for the disposable filter is shown in Fig. 22. This figure shows that higher efficiencies and lower pressure drops are obtained at lower air flows. The two efficiency curves represent the filter efficiency with 0 kV and 8 kV applied to the filter electrodes. The efficiency of the electrofibrous prefilter is much higher at the lower air flows because of the increased residence time that permits the electrical forces to attract particles.

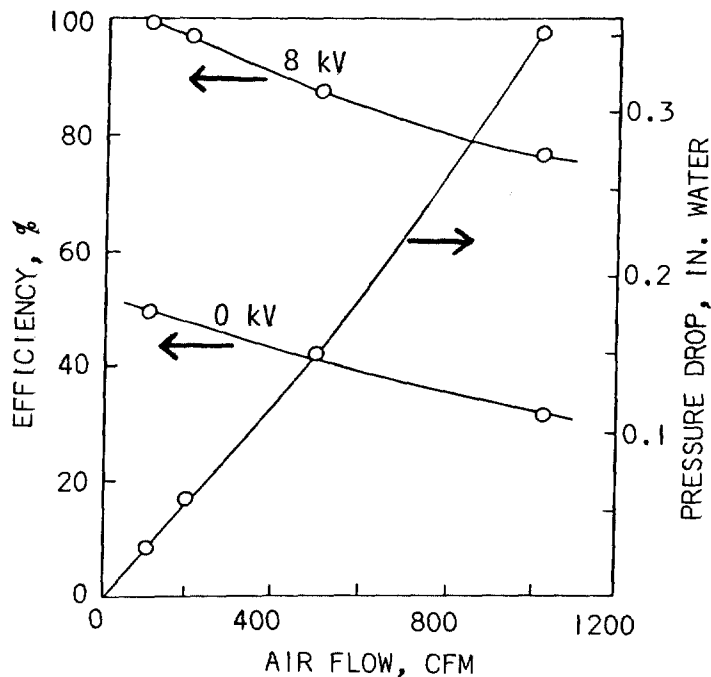

Figure 22. Filter efficiency and pressure drop as a function of air flow for the disposable electrofibrous prefilter.

### IV. Field Evaluation of Stationary Electrofibrous Prefilters in LLNL's Uranium Burn Box

We then made preparations to install the electrofibrous prefilter in LLNL's uranium burn box. We selected this box for our field evaluation because it had one of the highest rates of radioactive particulate emissions at LLNL and would therefore provide field data within a relatively short time. Figure 23 is a photograph of the uranium burn box before we modified it for our field evaluation. The uranium burn box was designed to oxidize machine turnings and chips of depleted uranium metal to convert it into a stable form for shipment and burial. If the uranium turnings were not stabilized they would ignite and burn when exposed to oxygen. Uranium turnings are brought to the facility in barrels filled with water to prevent premature oxidation.

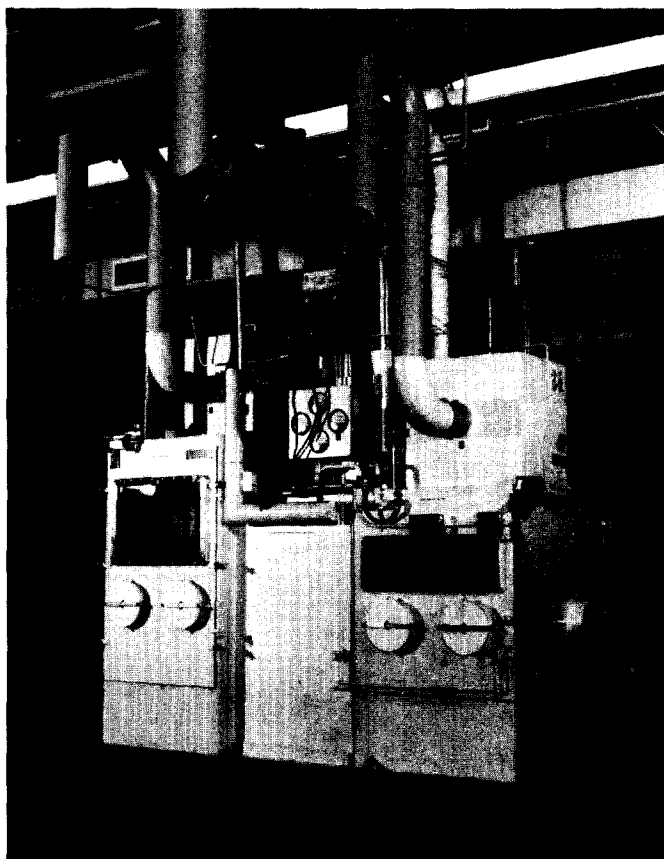

Figure 23. Uranium burn box at LLNL prior to our field evaluation.

The first step in the operation of the burn box is to load a barrel into the left side of the burn box as shown in Fig. 24. The barrel is then mounted on a pivot and the lid removed as shown in Fig. 25. After the access door is closed, the box is purged with an argon atmosphere. The contents of the barrel are then poured into a tray located beneath the barrel that sieves out the turnings from the water/oil mixture. Since the barrels often contain sludge, the turnings are usually washed with water. The tray of uranium turnings is then moved into the center chamber of the burn box (see Fig. 23) where the turnings are ignited with an electric arc and burned in a controlled fashion by adding oxygen. After the oxidation is complete and the tray cooled down, the tray is then transferred to the chamber on the right in Fig. 23. Here the ash is transferred to disposal barrels by air suction.

Each of the three chambers in Fig. 23 has a separate exhaust and HEPA filter that connect to a common exhaust line. The exhaust from the two end chambers passes through a 500 cfm HEPA filter mounted on top of the respective

## 17th DOE NUCLEAR AIR CLEANING CONFERENCE

chambers. A heat exchanger inside the center chamber cools the exhaust before passing through two 135 cfm HEPA filters. The exhaust from this chamber is saturated with water vapor and has an extremely high particulate loading. These severe conditions would cause the two 135 cfm HEPA filters to plug after about three days of operation and force the operation to be shut down until the filters were changed. An examination of the HEPA filters showed they had a heavy particle deposit and were saturated with water.

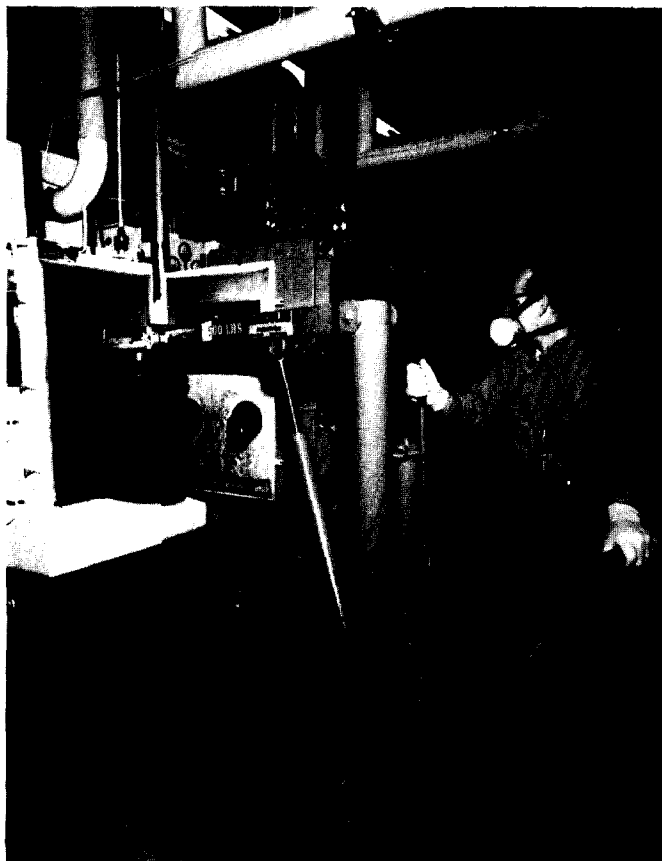

Figure 24. Operator loading a barrel of uranium turnings into the burn box.

Except for the saturated water in the exhaust, the uranium burn box appeared to be a good choice for evaluating our electrofibrous prefilter. However before we could install our electrofibrous prefilter we had to reduce the water vapor in the exhaust. We experimented with a number of different schemes for chilling the exhaust to remove the water vapor but were not successful. The problem was due to the high particulate concentration causing the water separator to plug. Cooling the exhaust would form a mist of very small water droplets that could not be removed from the gas stream without also removing the uranium oxide particles. The only effective means for removing the water drops was a demister pad or a coarse filter that would also remove the uranium oxide particles and subsequently plug the filter. Since dehumidifying the exhaust would merely transfer the plugging problem from the HEPA filters to the water demisters, we abandoned this approach.



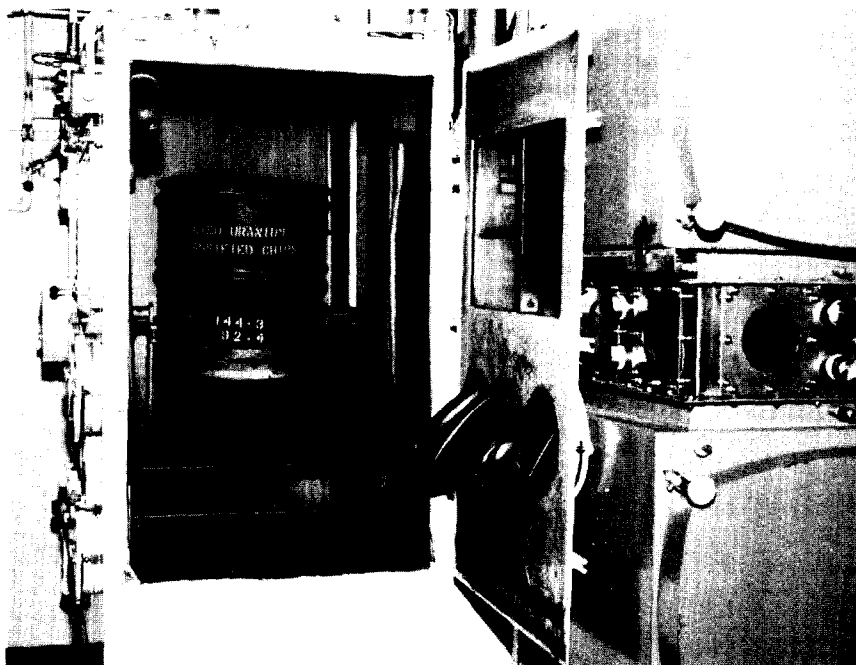

Figure 25. Barrel of uranium turnings mounted on a pivot inside the burn box.

At the suggestion of Dr. T. R. Thomas<sup>(6)</sup> we built a dilution system for reducing the relative humidity of the exhaust by dilution with room air. With the added dilution air, we increased the exhaust flow from about 60 cfm to 250 cfm. Further dilution was not possible without an extensive modification of the building ventilation system. To reach a reasonable level of relative humidity, we then added a heater to the dilution air. Adding hot dilution air to the exhaust from the burn box thus provided a reasonable environment for evaluating our disposable electrofibrous prefilter.

We then built and installed a special ventilation system shown in Fig. 26 for evaluating our electrofibrous prefilter. The ventilation system consisted of two HEPA filter housings obtained from MSA and appropriate transition ducting. A sufficient number of viewing ports were added to the transition ducts to permit visual inspection of the prefilter and HEPA filter. We also added pressure gauges to measure the pressure drop across the prefilter and HEPA filter, a hot wire probe to measure the total exhaust flow and a light scattering photometer to measure the efficiency of the prefilter. This diagnostic equipment enabled us to evaluate the performance of the prefilter on a routine basis. We will also periodically measure the size distribution of the uranium oxide particles using additional instruments.

We then installed the disposable electrofibrous prefilter in the exhaust ventilation system as illustrated in the following sequence of photographs. Figure 27 shows two operators removing the cover off the top filter housing. The electrofibrous prefilter is then lifted into the filter housing in Fig. 28. Note that the disposable prefilter is mounted in a clear plastic frame.

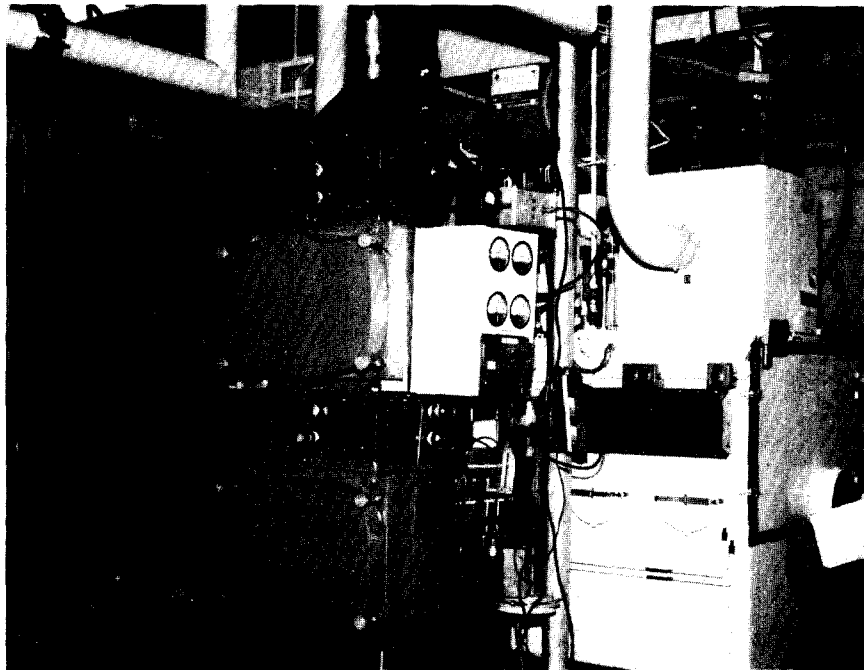

Figure 26. Ventilation system built for evaluating the disposable electrofibrous prefilter.

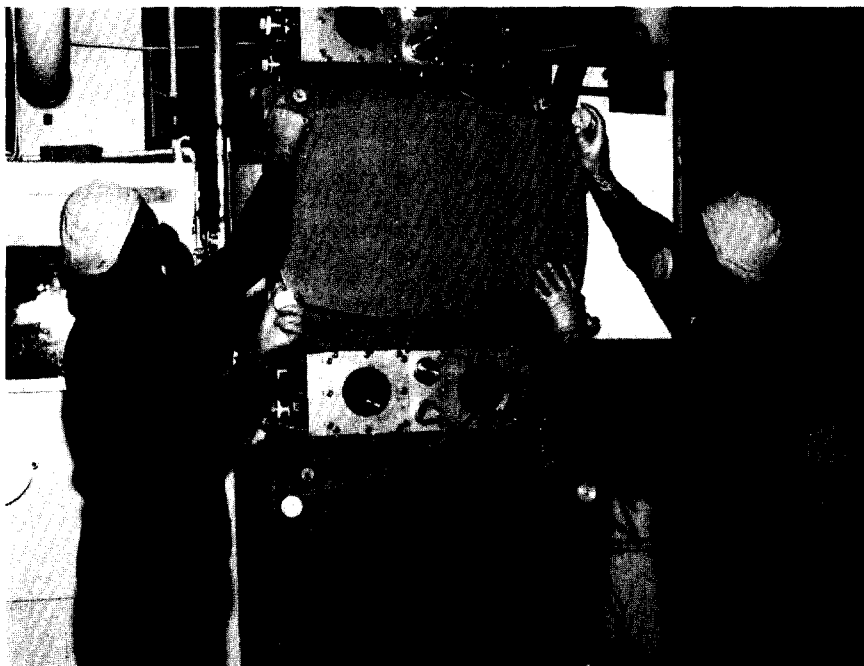

Figure 27. Operators removing the filter housing cover.

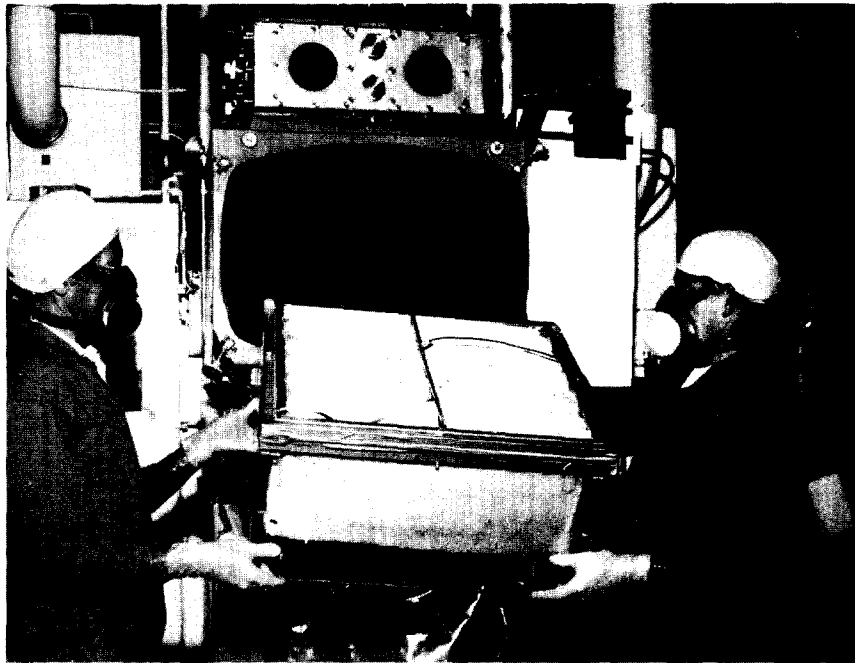

Figure 28. Disposable electrofibrous prefilter being inserted into the filter housing.

This was necessary since the filter housing was intended for HEPA filters. Before the prefilter was pushed into the filter holder, the high voltage lead from the filter was connected to the high voltage cable inside the housing (Fig. 29). The prefilter was then clamped against the sealing flange in the filter housing (Fig. 30) and the cover replaced over the filter housing. Figure 31 shows the electrofibrous prefilter installed inside the filter housing as seen through one of the viewing ports. Note the high voltage lead extending from the electrofibrous prefilter to a throughput on the ducting wall. The horizontal rod in the photograph is the upstream aerosol sample line that can traverse the width of the filter housing.

We then evaluated the performance of the disposable electrofibrous prefilter during a normal burn operation. The experimental results obtained from the first burn following the prefilter installation is shown in Fig. 32. This figure shows the efficiency of the prefilter in trapping uranium oxide particles with and without high voltage. We measured the filter efficiency without high voltage by periodically turning off the high voltage power supply. The high voltage increases the filter efficiency from about 95% to 99%. This represents an 80% reduction in the particles reaching the downstream HEPA filter. During the 50-minute test the pressure drop across the prefilter increased from 0.17 inches to 0.35 inches of water. The large spike in current across the high voltage and ground electrodes was presumably caused by an excessive amount of water vapor generated during the start up of the burn.

## 17th DOE NUCLEAR AIR CLEANING CONFERENCE

We plan to monitor the performance of the prefilter in a similar fashion to establish the particle loading capacity of the prefilter and extension in HEPA service life. Since the uranium oxide particles appear to form a rather loose deposit on the filter surface, we will also explore methods for cleaning the prefilter for reuse. The extremely high particulate emissions from the burn box will certainly provide a considerable amount of data to examine a number of questions regarding the use of stationary electrofibrous prefilters in nuclear ventilation systems.



Figure 29. Operator connecting the high voltage lead from the filter to the high voltage cable inside the filter housing.

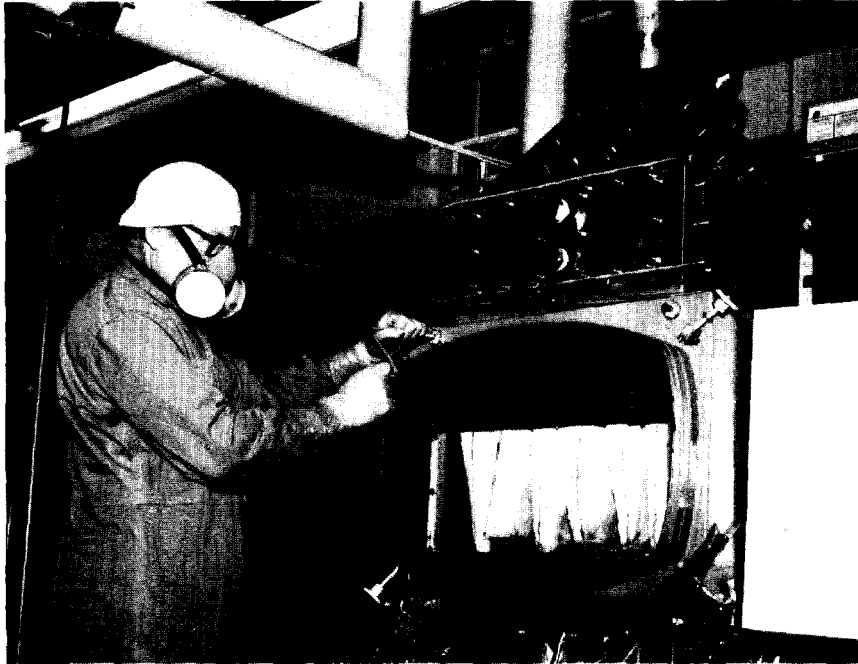

Figure 30. Operator clamping the prefilter against the sealing flange.

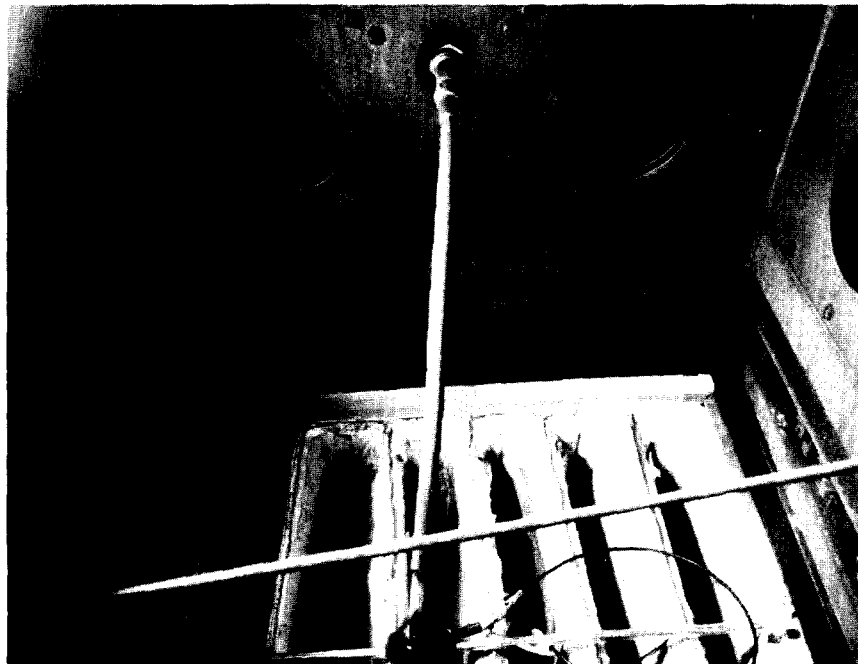

Figure 31. Disposable electrofibrous prefilter installed in the filter housing.

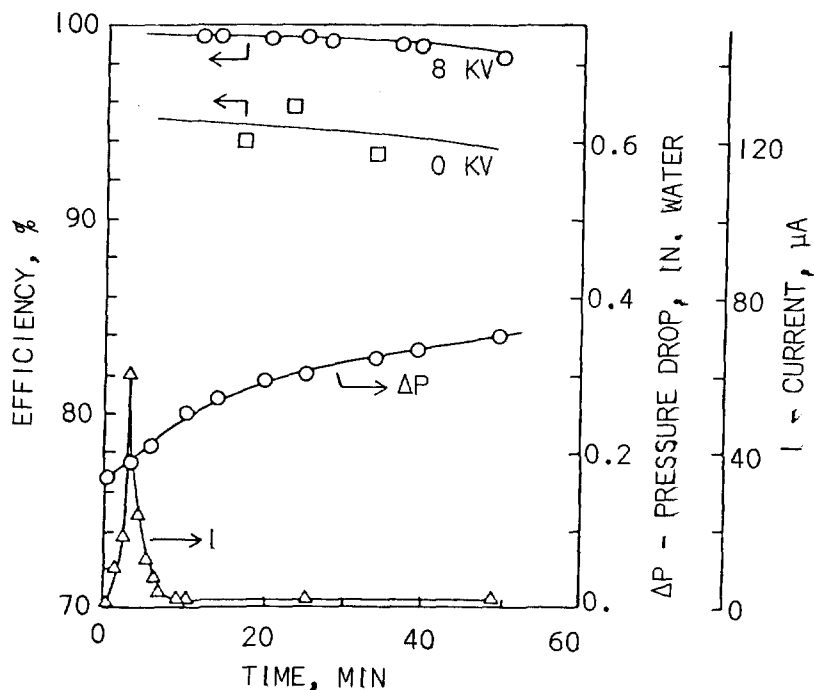

Figure 32. Performance of disposable electrofibrous prefilter during a uranium burn operation.

#### V. Summary

Numerous studies have shown that applying an electric field across a fibrous filter medium will significantly improve its efficiency and dust holding capacity. The application of an electric field is accomplished by sandwiching high voltage screens between a fibrous medium. In this report, we described the design, fabrication and evaluation of two prototype electrofibrous filters using these principles. These prototypes differ in the specific design depending on the intended application and method for changing the filter medium.

The two prototypes described in this report were designed for use in standard nuclear ventilation ducts as prefilters to HEPA filters. One of these prototypes is designed as a permanent filter unit in which the front electrode is mounted on sliders that permit easy replacement of the filter medium. The second prefilter design is a disposable filter that consists of a pleated electrified filter medium attached to a supporting frame. The electrodes are a wire cloth glued directly onto the filter medium. In this design the entire filter is discarded when the filter medium becomes plugged. The disposable filter was evaluated at LLNL in the exhaust stream of a glove box in which barrels of uranium turnings and chips are burned. Preliminary tests show the electrofibrous prefilter is very effective in prolonging the HEPA filter life.

## 17th DOE NUCLEAR AIR CLEANING CONFERENCE

### Bibliography

1. Bergman, W., Taylor, R. D., Miller, H. H., Biermann, A. H., Hebard, H. D., da Roza, R. A. and Lum, B. Y., "Enhanced filtration program at LLL - a progress report," Proc. 15th DOE Nuclear Air Cleaning Conference. Boston, MA, August 7-10, 1978. CONF-780819, NTIS, Springfield, VA. pp 1058-1098 (1979).
2. Nelson, G. O., Bergman, W., Miller, H. H., Taylor, R. D., Richard, C. P., and Biermann, A. H., "Enhancement of air filtration using electric fields," Am Ind. Hyg. Assoc. J., 39 pp. 472-479 (1978).
3. Bergman, W., Hebard, H., Taylor, R., and Lum, B., "Electrostatic filters generated by electric fields," in Proceedings of the Second World Filtration Congress, September 18-20, 1979. London, England, Uplands Press Ltd., 1 Katharine Street, Croydon CR9 1LB, England, unpagged, (1979).
4. Bergman, W., Biermann, A. H., Hebard, H. D., Lum, B. Y. and Kuhl, W. D., "Electrostatic air filters generated by electric fields," Proc. of Fine Particle Society Meeting, Maryland (1980).
5. Bergman, W., Kuhl, W. D., Russell, W. L., Taylor, R. D., Hebard, H. D., Biermann, A. H., Alvares, N. J., Beason, D. G., and Lum, B. Y., "Electrofibrinous prefilters for use in nuclear ventilation systems," 16th DOE Nuclear Air Cleaning Conference, Oct. 20-23, 1980, San Diego, CA. CONF-801038, NTIS, Springfield, VA, pp. 807-836 (1981).
6. Thomas, T. R., Exxon Nuclear Idaho Company, Idaho Falls, Idaho, Private Communication, December (1981).

## DISCUSSION

GERBER: What is the outlook for electret material optimized for use in filter media?

BERGMAN: Very good. The variety of durable polymers having high resistivities and the large number of different techniques for generating electrets assures the availability of electrets that are both stable and have a high charge. Most filter manufacturers have in the past simply thrown together the electret filters without consideration of designing the filter to prevent fiber charge deterioration. I believe a great deal can be done in this area to improve the filter type of filter, but I cannot disclose these items until adequate patent protection is obtained.

ETTINGER: What would be the effect of typical atmospheric contaminants on the performance of the electrostatic filter?

17th DOE NUCLEAR AIR CLEANING CONFERENCE

BERGMAN: Most atmospheric aerosols have very little charge and consequently would cause only a small decrease in the fiber charge. Subsequent decrease in filter efficiency would not occur before mechanical collection becomes dominant due to the particle deposits. One has to be very cautious about atmospheric aerosols if there is a possibility of high humidity and oil or other organic solvents being present. Organics generally wet the filter and will permit filter discharge.

MURROW: Have you used the filter in conjunction with HEPA filters? Have you passed clean air through the charged filter, then introduced an aerosol later and measured the change in penetration through a HEPA filter?

BERGMAN: The answer to both questions is, no.

DYMENT: Have demonstrations of enhanced dust holding capacity of the electrofibrous filters been carried out using practical aerosols, e.g., uranium oxide from the "burn box" or atmospheric dust?

BERGMAN: There are many reports available on the demonstration of enhanced dust loading with electrofibrous filters with the use of fly ash. These reports were written by Geroge Lamb, Textile Research Institute, Princeton, NJ and by an EPA group at Research Triangle Park, NC. Large scale pilot plants have been built using external electrodes to generate electrofibrous filters. We have, to date, had field evaluations in 1) a U/Be fuel rod manufacturing glove box, 2) a Pu vacuum box that collected Pu salts like a vacuum sweeper-(it was a very dusty box) and 3) a U-burn box (this just recently started). We have only been able to measure potential subcritical dust loading for our first evaluation. The data indicate only a slight enhancement. We plan to eventually have such data for the other two field installations.

DYMENT: Has a realistic cost evaluation been carried out on any of the prototype filter units including capital and operating costs, and comparing them with a non-enhanced system?

BERGMAN: No.



## 17th DOE NUCLEAR AIR CLEANING CONFERENCE

### A NEW METHOD OF DETERMINING THE OVERALL PARTICLE DECONTAMINATION FACTOR FOR MULTIPLE OFFGAS CLEANING COMPONENTS IN REPROCESSING PLANTS

J. Furrer, A. Linek  
Laboratorium für Aerosolphysik und Filtertechnik  
Kernforschungszentrum Karlsruhe GmbH  
Postfach 3640, D-7500 Karlsruhe 1  
Federal Republic of Germany

#### Abstract

When combining aerosol retention components in the dissolver offgas stream of a reprocessing plant, the behavior both of the individual aerosol filter stages and the overall removal efficiency of all filters connected in series vis-à-vis an aerosol spectrum to be expected must be determined for the benefit of the licensing authority. A fast method of determining removal efficiencies is described, which can also be applied in hot operation. This method was used to demonstrate, with high certainty, decontamination factors of a whole filter train in the range of  $10^7$ .

#### 1. Introduction

In the concept of nuclear waste management applied in the Federal Republic of Germany, spent fuel subassemblies are transferred to a reprocessing plant after an interim storage of three years. The valuable reusable uranium and plutonium fuels can be recovered by means of the PUREX process.

The dissolution process can be carried out through the controlled addition of nitric acid at 105 - 108 °C. The rate of distillation in the course of dissolution is 5 - 10 % per hour for 2.7 m<sup>3</sup> solution per metric ton of uranium. The dissolver offgas is made up of water vapor, air, nitric oxides, aerosols, iodine, and krypton and xenon noble gases. The rate of flow of the carrier gas, i.e., air, varies between 70 and 140 m<sup>3</sup><sub>std</sub>/h; it consists of exhaust air from the shears, sparging air and leakage air.

When the fuel subassemblies are cut into pieces, the shears produce dust, part of which is dissolved in the dissolver, the rest being entrained in the offgas line with the exhaust air from the shears. On account of intensive agitation of the liquid as a result of the gas evolution during dissolution and of boiling and air sparging, liquid droplets will be entrained from the dissolver while bubbles burst on the surface. Parallel to the dissolution of fuel subassemblies, gaseous elemental fission product iodine is formed which is likewise removed effectively by the carrier gas.

Since the activity inventory in the dissolver is very high and the offgas line is heavily loaded with fission products, the downstream filter section must constitute a safety barrier retaining the fission products. After the dissolver condenser and the NO<sub>2</sub>-absorption and I<sub>2</sub>-desorption columns, respectively, there is the filter section proper with its droplet separators, HEPA filters and iodine absorption filters. The functional capability of this filter section must be proved prior to operation because otherwise elevated radioactive releases to the environment in excess of the authorized release levels could occur. Moreover, each filter unit constitutes a prototype <sup>(1)</sup> to be examined for its removal behavior under operating conditions prior to being installed in an active facility.

Owing to the low levels authorized for particle releases via the exhaust air path ( $\alpha$ -emitters  $\leq 0.05$  Ci/y;  $\beta$ -emitters  $\leq 5$  Ci/y according to the German Advisory Committee on Reactor Safety and the German Advisory Committee on Radiation Protection) with the offgas from German reprocessing plants, the most stringent requirements apply to the dissolver offgas line. The overall decontamination factor of the exhaust air filters must amount to at least  $5 \times 10^6$  in case of the  $\alpha$ -aerosol activity so as to avoid the permissible release levels from being exceeded.

## 2. The PASSAT Dissolver Offgas Cleaning Section

As part of the present Reprocessing and Waste Treatment Project it was decided in 1975 to build a full scale prototype dissolver offgas cleaning section on the premises of the Karlsruher Nuclear Research Center. <sup>(2, 3)</sup> After completion of the planning and construction phases, trial operation started in 1978.

The PASSAT facility consists of six filter components. For aerosol and halogen removal, the units have been installed in the system in the sequence indicated in Table 1.

The PASSAT facility (Fig. 1) is divided into four parts: The central part simulates a hot cell for offgas cleaning. It is equipped with full size remotely operated filter units; the second part consists of a rig for simulation of operating and accident conditions, respectively; the third part includes the analytical systems. The whole facility is controlled and supervised from the control room.

### Operating Data

Intake pressure	1 bar
Intake temperature in the exhaust air mode of operation	20 °C
Intake temperature in the recirculation air mode of operation	30 - 90 °C
Pressure upstream of the blower, min.	0.6 bar abs.
Gas flow	50 - 250 m <sup>3</sup> <sub>std.</sub> /h

**17th DOE NUCLEAR AIR CLEANING CONFERENCE**

NO <sub>2</sub> -fraction, max.	6 vol.%
Iodine concentration	~ 1 g/m <sup>3</sup>
Iodine-131, max.	~ 5 mCi per test
Ba-139 (NO <sub>3</sub> ) <sub>2</sub> , max.	~ 300 mCi per test

Table I: PASSAT units and expected removal efficiencies

U n i t s	F u n c t i o n
1. Wave plate droplet separator (WPS)	Removal of liquid droplets > 10 μm; retention factor > 90 %
2. Packed fiber mist eliminator (PFME)	Removal of liquid droplets < 10 μm; removal efficiency > 99 %; removal of solid particles
3. High efficiency particulate air filter (HEPA) I	Removal of solid particles < 0,3 μm; removal efficiency ≥ 99.97 %
4. Two iodine sorption filters arranged in series	Removal of iodine compounds by chemical sorption; removal efficiency > 99.9 %
5. HEPA filter II	Retention of aerosols from the iodine sorption system and additional action as a safety filter

3. Test Procedures and Measurement

The interplay of droplet separators (wave plate droplet separators and recleanable packed fiber mist eliminators) and HEPA filters is important in offgas cleaning, with the droplet separators acting as prefilters and removing most of the aerosols produced and returning them to the wet process. This increases the service life of the downstream HEPA filters and reduces the number of loaded filters to be disposed of as waste in a repository.

To determine the removal efficiencies of droplet separators, drops must be generated whose mass and number upstream and downstream of the separators can be determined and brought into a certain relationship by analytical systems. At the inlet of the PASSAT filter section, a reproducible droplet spectrum, Fig. 2, was generated by spraying a salt solution through a two-fluid nozzle. The spectrum varies between 1 and 23 μm with a max. number of droplets at 4 μm. Upstream and downstream of these separators, branch streams were isokinetically sampled of the main offgas stream. To determine results reliably, several methods were applied to assess the removal efficiencies for the different filter stages (Fig. 3):

17th DOE NUCLEAR AIR CLEANING CONFERENCE

1. by measuring drop sizes by means of the HC 15 drop size measuring unit employing the light scattering technique at WPS and PFME, (4)

2. by feeding the droplets into heated sections, in which the droplets evaporated, and collecting the remaining salt nuclei on nuclei-pore or aerosol filters at the WPS, PFME and HEPA filter points.

Table II: Solutions and analytical approaches employed to determine the decontamination factors of WPS, PFME, and HEPA filters

Solutions	Concentration of spray solution	Analysis	Limit of detection
NaNO <sub>3</sub>	1 %	Na <sup>+</sup> ion sensitive electrode	0.2 ppm Na <sup>+</sup> ≅ 7.6 x 10 <sup>-6</sup> g Na <sup>+</sup> / 10 ml of solution
Na fluorescein	0.01 %	Fluorimeter	5 x 10 <sup>-11</sup> g/ml of solution
<sup>139</sup> Ba(NO <sub>3</sub> ) <sub>2</sub>	1 % 1.2 g of <sup>137</sup> Ba + <sup>139</sup> Ba (300 mCi)	Multichannel-analyzer, Ge(Li)	approx. 10 <sup>-11</sup> g

Table II is a list of the solutions sprayed from the two-fluid nozzle and the analyses carried out subsequently. The sodium nitrate and sodium fluorescein solutions were fed into the two-fluid nozzle straight from a feed tank. To spray the barium nitrate solution (with <sup>139</sup>Ba added as a tracer) into the gas stream required special safety precautions. In a movable vessel shielded with lead (Fig. 4), the irradiated glass ampoule filled with Ba(NO<sub>3</sub>)<sub>2</sub> was broken, hot water was added for rapid dissolution of the Ba(NO<sub>3</sub>)<sub>2</sub> and the solution was agitated. Afterwards, the solution was flushed out of the chamber with water and sprayed into the main gas stream from the nozzle. Compared with the number of hours required to produce and sample sodium nitrate and sodium fluorescein (for a sufficient limit of detection over the entire system) the time required for spraying and sampling radioactively labeled barium nitrate amounted to only a few minutes. (5)

## 4. Results

### 4.1 Removal of Droplets in the Wave Plate Droplet Separator (WPS)

The WPS is located at the inlet of the dissolver offgas section. It serves mainly two functions 1) removal of large droplets (approx.  $> 10 \mu\text{m}$ ) in normal operation, to reduce the load on downstream components; 2) bulk separation of larger volumes of liquid or droplets in case of maloperation in the upstream sorption columns.

Scattered light measurements were conducted to determine the lower limit droplet sizes for volume streams of  $75 - 150 \text{ m}^3_{\text{std.}}/\text{h}$  at  $30^\circ\text{C}$  and  $100\%$  r. h.. With the face velocity rising from  $0.63$  to  $1.26 \text{ m/s}$ , removal is shifted towards the smaller droplets. The drop size limits at a removal efficiency of  $90\%$  for the volume streams of  $75$ ,  $125$ , and  $150 \text{ m}^3/\text{h}$  respectively amount to  $9 \mu\text{m}$ ,  $7.5 \mu\text{m}$ , and  $6.5 \mu\text{m}$ . The mass removal efficiencies at the different volume streams were determined by ascertaining the number of the corresponding droplet sizes per unit volume in the intake and exhaust air. The mass removal efficiency rises from  $30$  to  $70\%$  between  $75$  and  $150 \text{ m}^3_{\text{std.}}/\text{h}$ .

Additional series of tests were carried out to determine removal by spraying a salt solution and sampling on nuclei-pore filters through heated sampling tubes, Table II. The droplets dried down to the salt nuclei on their way from the sampling point to the nuclei-pore filters. The droplet mass was calculated from the amount of salt precipitated on the nuclei-pore filters and the given concentrations of salt solution sprayed. With increasing volume flow (from  $50$  to  $150 \text{ m}^3_{\text{std.}}/\text{h}$ ) the mass removal efficiency rises from  $24$  to  $76\%$ . This causes the pressure drop across the separator to increase from  $0.5$  to  $3 \text{ mbar}$  (Fig. 5).

### 4.2 Removal of Droplets in the Packed Fiber Mist Eliminator (PFME) (Brink Type Filter) (6)

The packed fiber mist eliminator acting as a recleanable fine droplet separator was used to measure the decontamination factors for the droplet spectrum downstream of the wave plate droplet separator for volume flows between  $50$  and  $150 \text{ m}^3_{\text{std.}}/\text{h}$ .

The removal behavior of PFME as a prefilter in PASSAT has already been described at the last DOE Air Cleaning Conference. (3) Factors of particular importance were the retention of radioactively labeled  $\text{Ba}(\text{NO}_3)_2$  droplets downstream of the wave plate droplet separator. At volume flows of  $50$  to  $150 \text{ m}^3_{\text{std.}}/\text{h}$ , the removal efficiencies measured were always  $> 99\%$ .

It can be seen from Fig. 6 that, in normal operation, the removal efficiency for the impinging droplets decreases with increasing volume flow. At  $50 \text{ m}^3_{\text{std.}}/\text{h}$ , the removal efficiency is  $99.95\%$ , which is due to the low face velocity of  $1.9 \text{ cm/s}$  and thus to the long residence time of the droplets in the fiberglass layer of  $5 \text{ cm}$  thickness and a packing density of  $300 \text{ kg/m}^3$ . At higher face

velocities of 5.8 cm/s at  $150 \text{ m}_{\text{std.}}^3/\text{h}$ , the removal efficiency drops to 99.83 %. The differential pressure across this prefilter in normal operation is between 5.5 and 13.2 mbar (Fig. 7). Under conditions of loading with large drop volumes in accidents, a dependency on loading of the decontamination factor has been found (Fig. 8). In experiments with constant volume flows of  $100 \text{ m}_{\text{std.}}^3/\text{h}$ , 30 °C and 100 % r. h., the differential pressure across the cylindrical fiberglass packing rose by some 3 mbar as a result of the increasing accumulation of drops. With increasing drop loading, the decontamination factor decreases. This is attributed to the following effects of water storage: enlargement of the effective fiber diameter, reduction in the free flow cross section with a resultant increase in flow velocity in the fiber pack. After drainage of the liquid, the decontamination factors measured previously are attained in normal operation.

#### 4.3 Removal of Particles on the Remotely Operated HEPA Filter

##### The Remotely Operated HEPA Filter

The remotely operated HEPA filter housing provided with a hinged and shielded lid (Fig. 9) accommodated a cylindrical HEPA filter element exposed to a flow from inward to outward. The five filtering segments are arranged vertical as rectangles in the stainless steel housing of the filter element. The segments are equipped with pleated fiberglass media, the total filter area being  $7.2 \text{ m}^2$ . An  $\text{NO}_2$  resistant elastomer adhesive seals the filter media relative to the filter frame. The bottom part of the filter element has a dish, which is closed during filter replacement. The crane grab grasps the filter at the mushroom-shaped head and the dish is moved upwards to seal the upstream side of the filter during crane operation, thus confining the aerosols deposited in the filter so that no contamination by loose of aerosols occurs in the cell.

The newly conceived particulate air filter serves to retain particles with diameters  $\leq 0.3 \text{ }\mu\text{m}$ . One should be able to prove that the decontamination factor attains a  $\text{DF} \geq 3000$  ( $\geq 99.97 \%$ ) for different offgas throughputs and simultaneous aerosol loading with test aerosols.

The main problem in examining the removal efficiency of HEPA filters consists in the choice of an appropriate test aerosol with a narrow particle spectrum and an average aerodynamic diameter of the aerosol corresponding to the diameter at maximum penetration so that the measured results are on the safe side. (7)

The concentration of salt nuclei originating from drops not removed by the drop separator after evaporation is very low when the removal efficiency in the HEPA filter is determined. Also if drops are fed over several hours (6 - 10 h), and sodium nitrate and sodium fluorescein solutions are used, the high prefiltration makes it impossible to measure any removal efficiencies in the HEPA filter.

As a test method used to determine the removal efficiency for solid particles on a comparison basis, the uranine method was used. (8) The majority of the particles were 0.15  $\mu\text{m}$  in size (SEM evaluation, Fig. 10).

Parts of the upstream and downstream air were carried to nuclei-pore filters and the mass removed determined with a fluorescence spectrometer. The decontamination factors evaluated from the mass ratios are indicated in Table III for different volumetric flows together with the average rates of the inlet flow for a gas temperature of 80  $^{\circ}\text{C}$ .

Table III: The decontamination factors of the HEPA filter as a function of the volumetric flow,  $\dot{V}$ , and the average face velocity,  $\bar{v}$ , respectively (error  $\pm 20$  %).

$\dot{V}$ ( $\text{m}^3_{\text{std.}}/\text{h}$ )	75	110	125	150	200
$\bar{v}$ (m/s)	0.38	0.58	0.66	0.79	1.05
DF ( $10^4$ )	9.3	6.7	2.9	7.7	5.2

In the range to be investigated of 75 - 200  $\text{m}^3_{\text{std.}}/\text{h}$  of flow, decontamination factors between  $10^4$  and  $10^5$  were attained in all tests even for Ba-139 ( $\text{NO}_3$ )<sub>2</sub>, (the maximum measurable DF was  $10^5$  under the prevailing conditions).

### 5. Summary and Future Activities

The test methods described above can all be used in experimental facilities for aerosol filter testing and in nuclear aerosol filter systems with low offgas contamination levels. To determine filter removal efficiencies in a filter line containing several barriers and involving high contamination levels, a method can be used which employs radioactively labeled particles, such as Ba-139. In this case, a relatively high gamma activity (e.g., 300 mCi) is sprayed into the offgas as a salt solution within a matter of a few minutes (peak delivery). Sampling takes only very little time; thus the possibly disturbing activity accumulated on the sampling filters is kept very low. Fig. 11 is a plot of the overall decontamination factor of the PASSAT aerosol filter line as a function of the flow up to 150  $\text{m}^3_{\text{std.}}/\text{h}$ . The decontamination factors measured, from wave plate droplet separator through packed fiber mist eliminator and high efficiency particulate air filters, are in excess of  $2 \times 10^7$ . In this way, a method has been applied which can be used in active facilities to measure the discrete Ba-139 gamma line on a Ge(Li) detector in the presence of other radioactive aerosols.

## 17th DOE NUCLEAR AIR CLEANING CONFERENCE

The PASSAT dissolver offgas filter system has been designed to an overall decontamination factor for aerosols of  $5 \times 10^6$  in normal operation. Decontamination factors in the range of  $10^7$  are attained with high assurance. Further studies in connection with a dissolver and an  $\text{NO}_2$  scrubber column are planned to demonstrate the behavior of the filter section when run together with these plant components in normal operation and under simulated accident conditions and in case of failure of a system component, respectively. Integrated operation will be started in 1983.

### 6. REFERENCES

- (1) K. Jannakos, W. Lange, G. Potgeter, J. Furrer, J. G. Wilhelm:  
"Selected Solutions and Design Features from the Design of Remotely Handled Filters and the Technology of Remote Filter Handling".  
CONF - 801 038, p. 317 (1980).
- (2) J. Furrer, J. G. Wilhelm, K. Jannakos:  
"Aerosol and Iodine Removal System for the Dissolver Off-Gas in a Large Fuel Reprocessing Plant".  
CONF - 780 819, p. 494 (1978).
- (3) J. Furrer, R. Kaempffer, A. Linek, A. Merz:  
"Results of Cleaning Dissolver Off-Gas in the PASSAT Prototype Dissolver Off-Gas Filter System".  
CONF - 801 038, p. 566 (1980).
- (4) H. Umhauer:  
"Ermittlung von Partikelgrößenverteilungen in Aerosolströmen hoher Konzentrationen mit Hilfe einer Streulichtmeßeinrichtung".  
Chem. Ing. Techn. 47 (1975), 7.
- (5) A. Merz, J. Furrer, A. Linek:  
to be published.
- (6) J. A. Brink:  
"Removal of Phosphoric Acid Mists".  
Chap. 5 in Gas Purification Process, George Newnes, Ltd. London 1964, Part B.
- (7) J. C. Kapoor et al.:  
"The Particle Size of Test Aerosol for HEPA Filters".  
Filtration and Separation 3, (1977).
- (8) J. Dupoux and A. Briand:  
Mesure in-situ de l'efficacité des installations filtrantes dans l'industrie nucléaire par la méthode à l'aérosol de fluoresceine sodée (uranine).  
NF X 44-011 (May 1972).



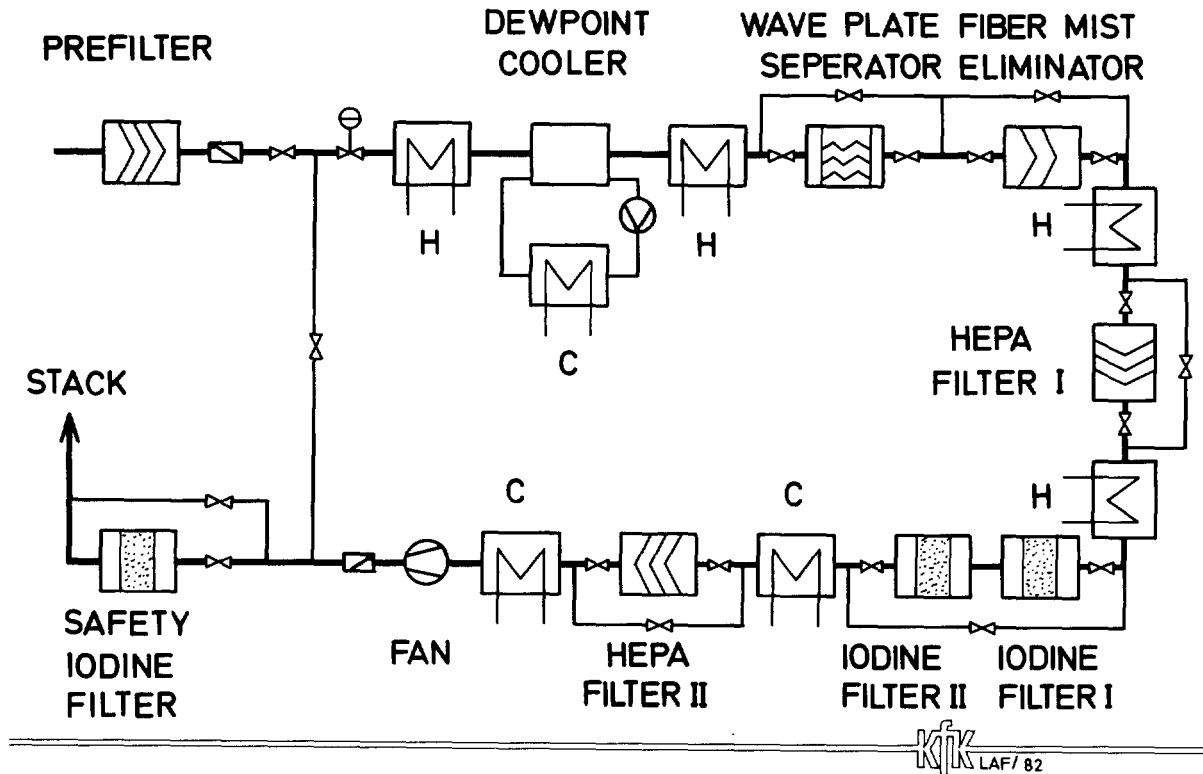

FIG. 1 FLOWSHEET OF THE PASSAT TEST FACILITY

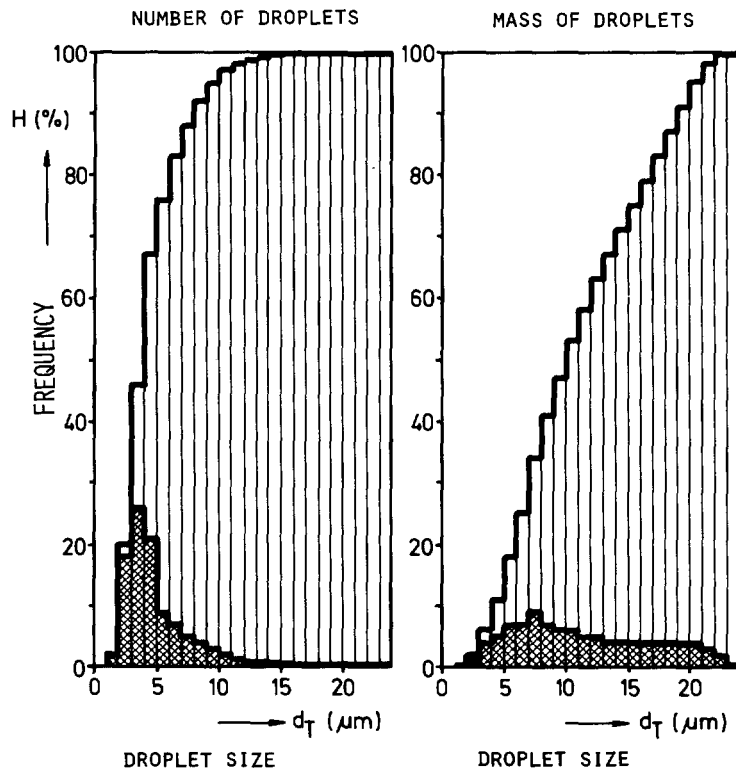

FIG. 2 SIZE DISTRIBUTION OF THE INJECTED DROPLETS FROM  $\text{Ba}^{139}(\text{NO}_3)_2$ , SODIUM FLUORESCIN AND  $\text{NaNO}_3$  SOLUTIONS IN PASSAT

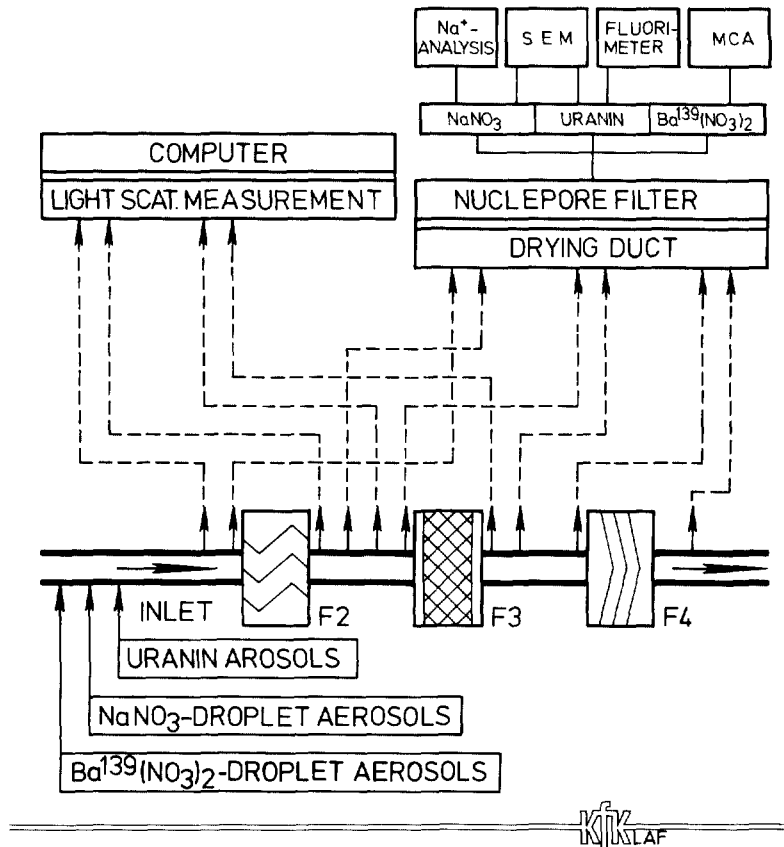

FIG. 3 AEROSOL SAMPLING AND ANALYSIS  
(F2: WPS; F3: PFME; F4:HEPA)

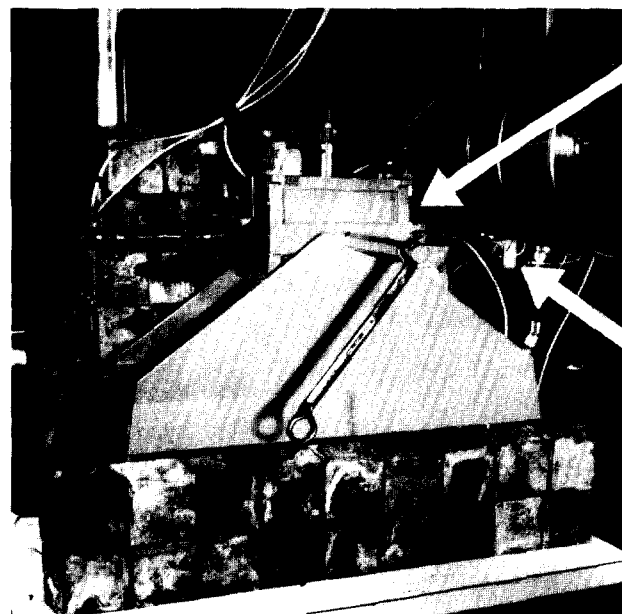

FIG. 4 INLET OF RADIOACTIVE BA(NO<sub>3</sub>)<sub>2</sub>

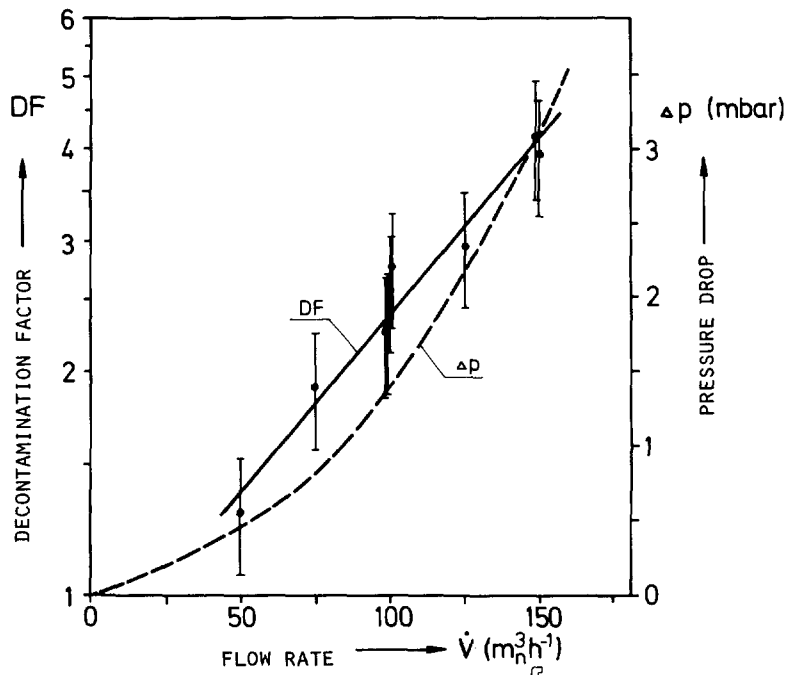

FIG. 5 WPS: DECONTAMINATION FACTOR AND PRESSURE DROP AS A FUNCTION OF THE FLOW RATE FOR DROPLETS (1 - 25  $\mu\text{m}$ )

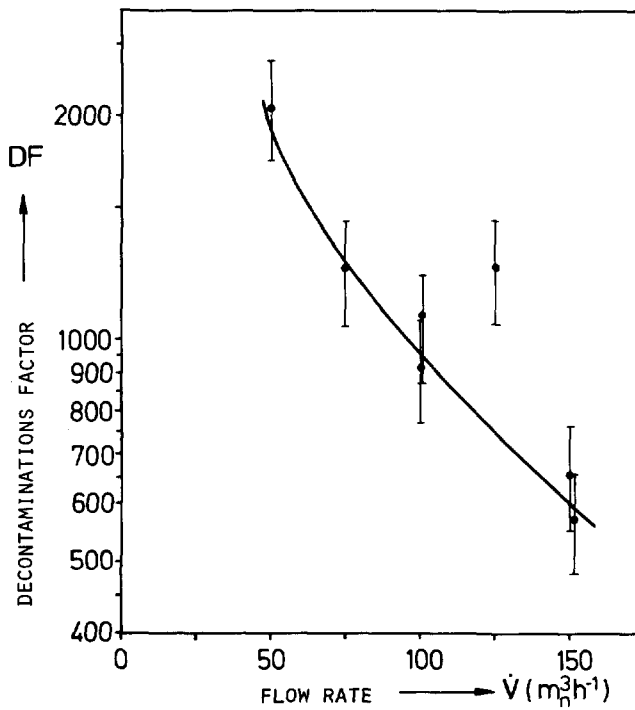

FIG. 6 PFME: DECONTAMINATION FACTOR AS A FUNCTION OF THE FLOW RATE

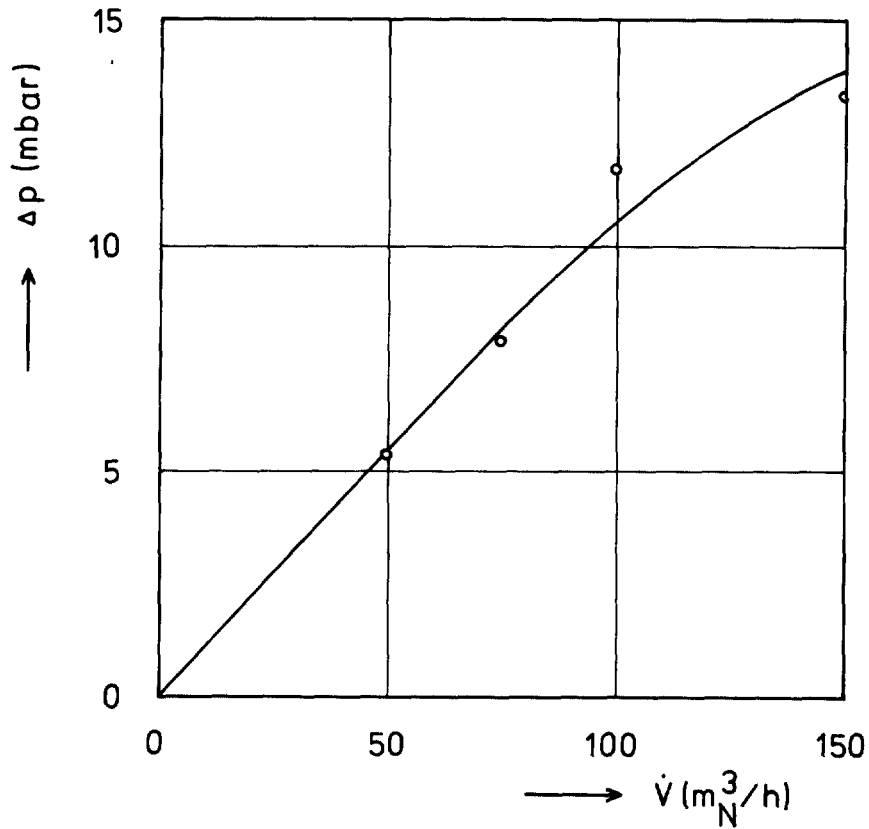

FIG. 7 PFME: PRESSURE DROP AS A FUNCTION OF FLOW RATE  
 ( $\theta = 30^\circ\text{C}$ ,  $\varphi = 100\%$  R.H., NOZZLE SPRAY RATE: 1 L/H)

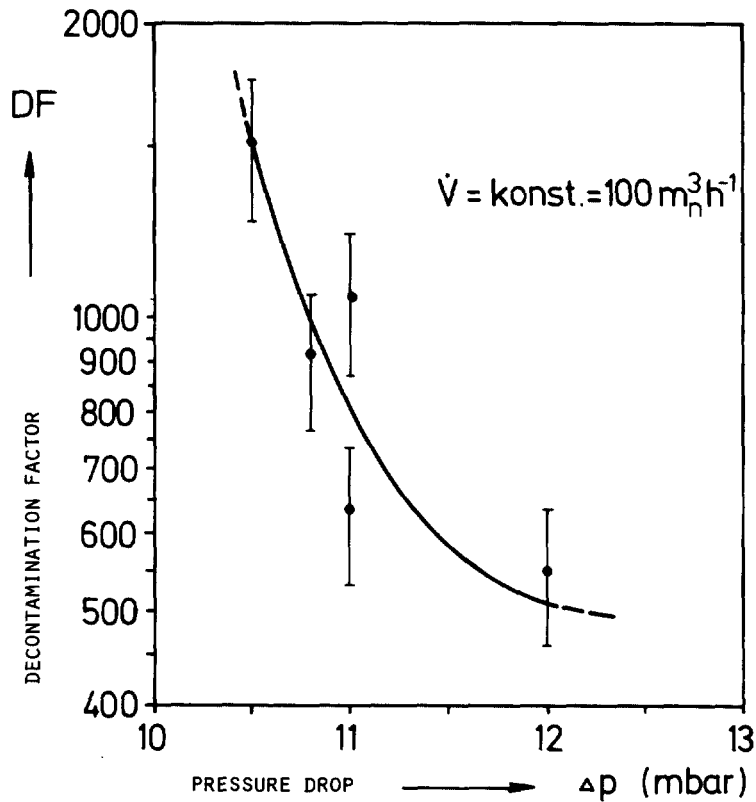

FIG. 8 PFME: DECONTAMINATION FACTOR AS A FUNCTION OF THE FILTER LOADING BY SOLUTIONS AT CONSTANT FLOW RATE

KIK LAF/82

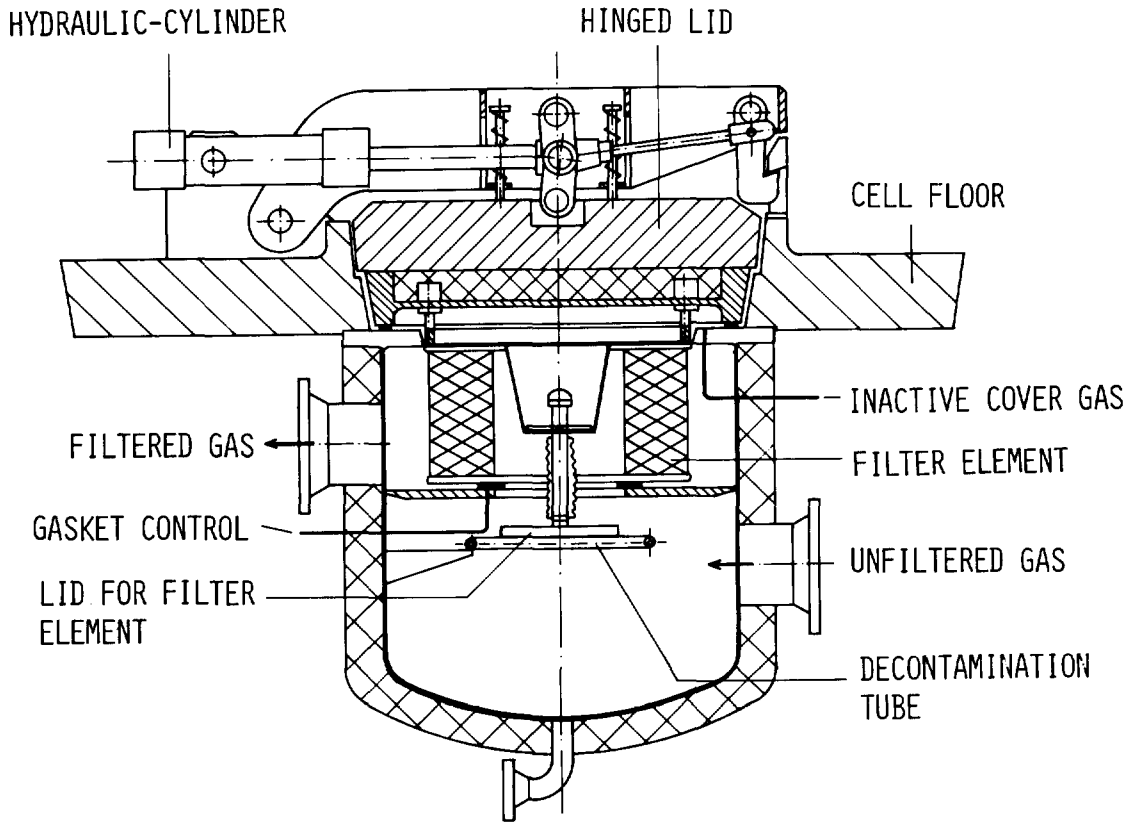

FIG. 9 PASSAT: REMOTELY OPERATED HEPA FILTER

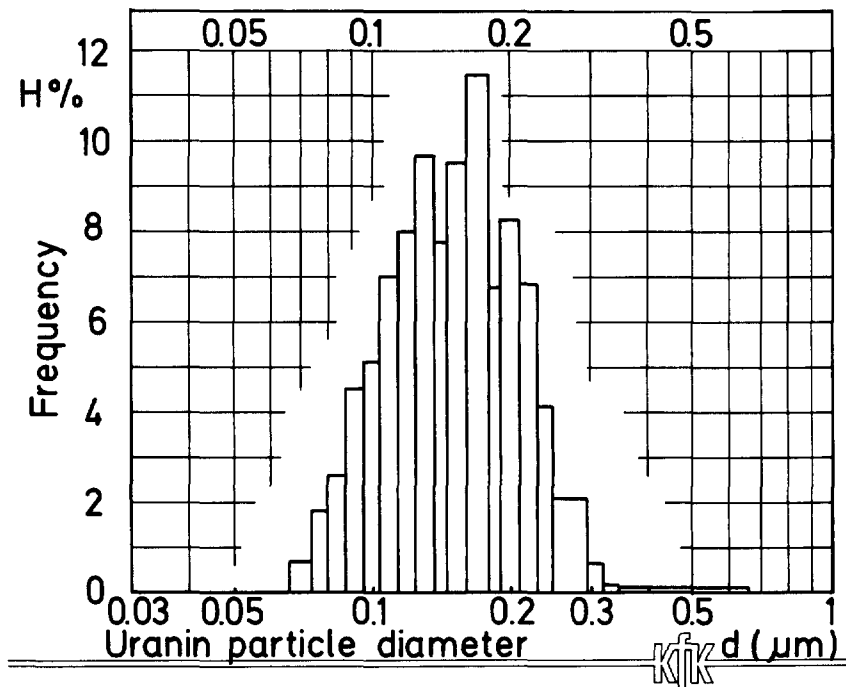
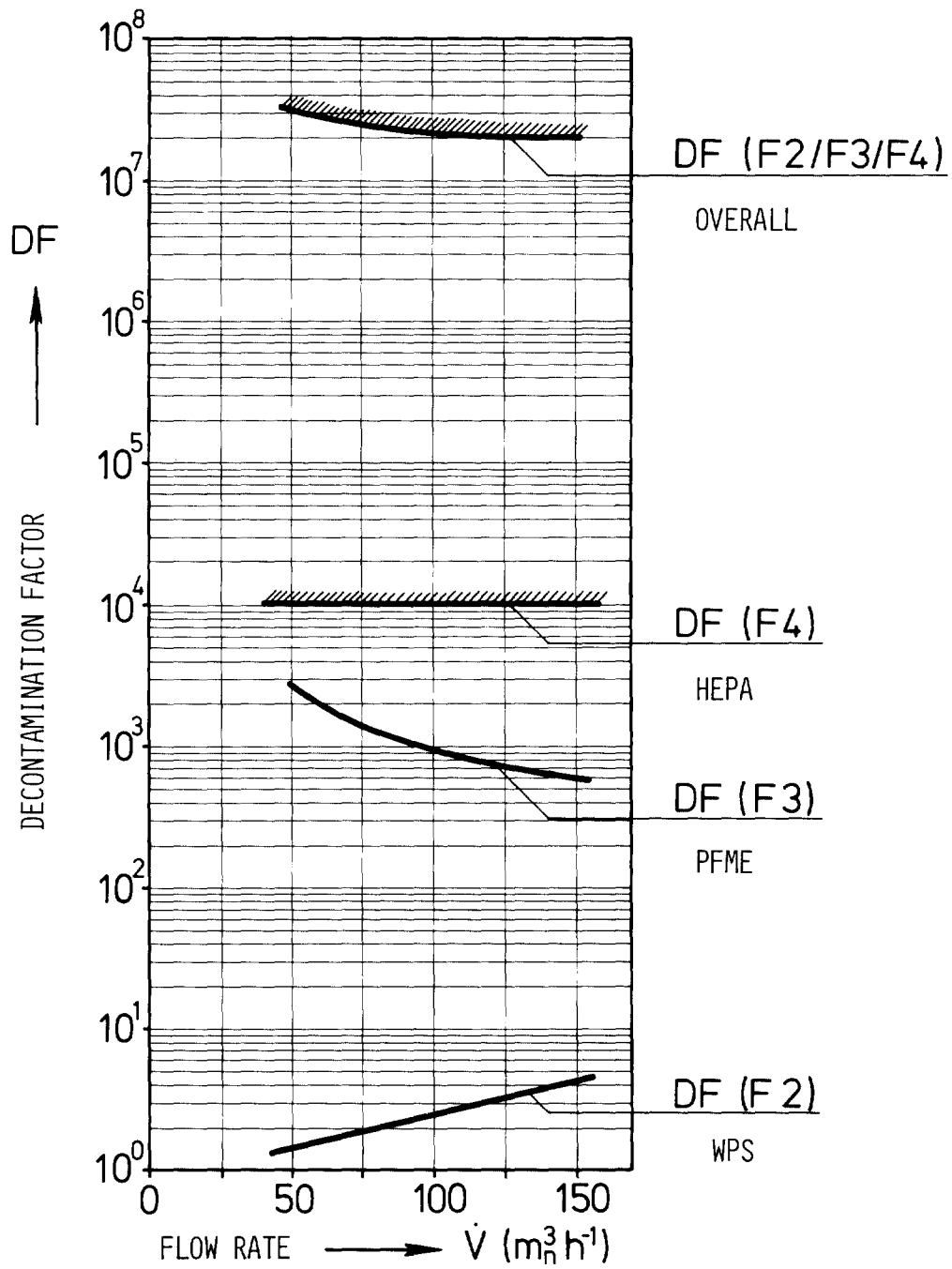

FIG. 10 URANIN PARTICLE SIZE DISTRIBUTION (SEM INTERPRETATION)



KfK LAF /82

FIG. 11 DECONTAMINATION FACTORS AS A FUNCTION OF THE FLOW RATE IN THE PASSAT FILTER SYSTEM

## 17th DOE NUCLEAR AIR CLEANING CONFERENCE

### DISCUSSION

ETTINGER: Did you calculate the system DF of  $10^7$  on the basis of a product of the DFs for each stage and/or the measurement of the overall DF?

FURRER: We did both. First, we tested each filter unit and then we injected  $Ba(NO_3)_2$  traced with Ba -139 and we took samples before the WPS and behind the HEPA filter. We found the same DF of more than  $10^7$ .

ETTINGER: Do you have criteria for scheduling the replacement of HEPA filters on the basis of time, pressure drop, etc.?

FURRER: The packed fiber mist eliminator is a recleanable prefilter with a removal efficiency for droplets and particles of more than 99.8%. The lifetime of the following HEPA filter will be about one year if there are no restrictions by the authorities. We loaded the HEPA filter with aerosols to a pressure drop of 15 inches without any decrease in removal efficiency.

# 17th DOE NUCLEAR AIR CLEANING CONFERENCE

## IN-SITU CONTROL OF FILTRATION SYSTEMS IN FRANCE : 5 YEARS EXPERIENCE

by J. DUPOUX

Commissariat à l'Energie Atomique, Institut de Protection  
et de Sûreté Nucléaire, Service de Protection Technique,  
SACLAY, France.

### Summary

For a number of years, French filtration systems have been subject to in situ control, using the soda-fluorescein (uranin) aerosol method. (AFNOR Standard NFX 44011).

Control results are presented in synthetic form, showing how system efficiency is affected by filtration velocity and by system design and construction.

The paper ends with a discussion of filtration performance changes with time.

### I. Introduction

The safety report of every French nuclear plant includes required performance data of filtration systems under normal and accident conditions.

To ensure that the equipment performs at the required level, systems are generally subject to three stages of control :

- measurement of filter element characteristics, to be used by vendors for preparing a guaranteed sheet for every type of element
- conformity check of 4% of the filter elements on order
- in situ control of every filtration system.

For efficiency measurements a single measurement method, i.e. the soda-fluorescein (uranin) aerosol method of AFNOR Standard NFX 44011 is used almost exclusively in France for the above three control stages.

Readers may refer to /1/ for a detailed description of the method. Further, a comparison of decontamination factors measured with the same paper filters, using the AFNOR method and the better-known foreign methods, is given in the table of Figure 1. Results obtained with foreign methods have been abstracted from Ref. /2/. Although there are disadvantages in using a single method, this facilitates cleaning system and system/filter element efficiency comparisons. This type of comparative assessment is discussed in the case of the acceptance testing of nuclear power reactor cleaning systems.

Data on performance changes with time are also given.

### II. New system acceptance

This report only covers the case of cleaning systems located at EDF sites having 2 or more 900 MW PWR reactors. All systems have unit flowrate of 600 to 200.000 m<sup>3</sup>/hr, (350 to 117.000 CFM) and feature the same type of filter element



## 17th DOE NUCLEAR AIR CLEANING CONFERENCE

with dimensions 610 x 610 x 292 mm, metal frame, paper/glass fiber, PVC seal ; filtration area is 35 to 36 m<sup>2</sup>. Filter elements can be mounted either in steel casings with side airlock-type outlets, or in concrete walls with steel platforms (Figures 2 and 3).

Figure 4 shows decontamination factor values plotted against the flowrate per filter element, based on :

- laboratory measurements on the relevant element type
- measurements performed at PWR sites or individual reactor systems, common systems and general auxillary systems.

We also give 5000 as the decontamination factor (0.02% penetration) guaranteed by the vendor for every filter element at a flowrate of 3400 m<sup>3</sup>/hr. For a given flowrate, it can be seen that decontamination factors measured on site, although lower than the filter element decontamination factor, are well above the value of 1000 required by the licensing authorities.

Decontamination factors of filter walls are slightly lower than those of metal casings.

The first inspection of the 200 systems accepted for reactors of the W 900 program has given the following results :

- 15 systems showed a decontamination factor under 1000.  
After defects were located and repaired, decontamination factor values were found satisfactory.

The following defects were found :

- wrong configuration : 3
- filter elements loose or poorly assembled : 5
- by-pass : 6
- damaged filter element : 1.

### III. Change of decontamination factor with time

#### III.1 - Prototype PWR systems

Prototype PWR systems are largely equipped with filter elements of a different type, and with lower performance ratings, than those of the W 900 program. These filter elements were inspected in early 1981. They had not been replaced since commissioning, which took place from June 1977 to May 1979.

At the time of commissioning tests, the flowrate per element was from 1100 to 1500 m<sup>3</sup>/hr (647 to 880 CFM) in systems No. 1 through 17, and approximately 400 m<sup>3</sup>/hr (235 CFM) in systems No. 18 through 21.

Results are tabulated in Figure 5.

Since the 1981 control showed system flowrates to be either the same or different from values found in commissioning tests, value R1, which is the ratio of uncorrected decontamination factors, has been supplemented by R2, the minimum value of R1 corrected for change in flowrate.

To that end, we have used the curve of Figure 4, showing changes in filter element decontamination factor against flowrate. It was fully realized that the curve could only be applied to a given system on an estimative basis, in view of system specific conditions such as the leakage rate.

For illustrative purposes, figure 6 shows the effect of leakage on the slope of the decontamination factor vs flowrate curve. Laboratory measurements were in good agreement with computed values /3/.

## 17th DOE NUCLEAR AIR CLEANING CONFERENCE

It can be observed that, in 16 of the 17 systems with different functions, and described by the owner as having been operating normally and for different lengths of time, ratio R2 is greater than 1, which shows that system efficiency has not been impaired.

In the case of system 17, ratio R2 is 0.26, where as ratio R1 is close to 1. A doubt remains as to the actual drop in system efficiency.

As regards systems 18 through 21, which have identical functions and where significant accidental waste condensation took place, the owner has discontinued using additional very high efficiency filters. However, subsequent checks showed a large drop in decontamination factor in 3 systems out of 4. When inspecting the filters in the three systems, large tears were found in the filter paper.

It therefore seems that, in the case of cleaning systems of PWR reactors where no operating incidents took place, filter efficiency does not usually decrease with time. This conclusion remains to be confirmed through additional testing on a yearly basis and the determination of pressure drop increases and operating conditions.

### III.2 - Cleaning systems in a non-reactor nuclear plant

We have been controlling the cleaning systems of this plant on a yearly basis since 1978.

Filters are of the metal casing type, with filter elements on the type used in PWR reactors of the W 900 program (chapter 2).

Results are shown in Figure 7. Decontamination factors increase in systems A, B, D and E, in which pressure drop increases little because the amount of deposited particles is small.

In system C, the initial decontamination factor is only slightly above 1000 due to a leakage rate estimated at 1 m<sup>3</sup>/hr. For that reason, the decontamination factor has remained the same from 1978 through 1981.

In system F, the initial decontamination factor was very high, and has risen although pressure drop at the filters was 91 mm W in 1981.

In system G, the increase in pressure drop to 160 mm W seems to have caused a decontamination factor reduction, although filter element resistance (with no change in decontamination factor) as guaranteed by the vendor is higher than 200 mm W.

Additional testing is required to determine the value of pressure drop in system filters which causes a reduction in decontamination factor.

R.P. PRATT /4/ gives compared resistance values obtained in dust loading tests on 610 x 610 x 292 mm filter elements, accelerated by using powders.

REFERENCES

- /1/ J. DUPOUX  
In situ measurement of the efficiency of filtration installations in the nuclear industry by the soda-fluorescein (uranin) aerosol method - AFNOR NFX 44011.  
16th DOE Nuclear Air Cleaning Conference, San Diego, USA, 20-23 october 1980, pp. 17-34.
- /2/ R.G. DORMAN  
A comparison of the methods used in the nuclear industry to test high efficiency filters.  
Commission of the European Communities, june 1981.
- /3/ F.J. LINCK, J.A. GREER  
In place testing of multiple stages Hepa filters plenums  
13th DOE Nuclear Air Cleaning Conference, San Franscisco, USA, 12-15 August 1974, pp. 526-539.
- /4/ R.P. PRATT  
A preliminary assessment of the dust loading versus pressure drop characteristics of high capacity Hepa filters.  
16th DOE Nuclear Air Cleaning Conference, San Diego, USA, 20-23 october 1980, pp. 697-707.

17th DOE NUCLEAR AIR CLEANING CONFERENCE

	Filtration velocity cm.s <sup>-1</sup>	Decontamination factor				
		1	2	3	4	5
DOP Q 127 0,3 μm	2	1,81.10 <sup>4</sup>	1.05.10 <sup>4</sup>	200	16,0	5,9
	4	1,05.10 <sup>4</sup>	4,25.10 <sup>3</sup>	104	11,0	4,8
	6	6,97.10 <sup>3</sup>	2,86.10 <sup>3</sup>	76	8,30	3,8
	8	4,76.10 <sup>3</sup>	1,94.10 <sup>3</sup>	68,9	7,55	3,6
	10	4,44.10 <sup>3</sup>	1,82.10 <sup>3</sup>	66,6	6,9	3,3
CINa BS 3928 (1)	2	1,25.10 <sup>5</sup>	2,0.10 <sup>4</sup>	500	38	13,5
	4	2,27.10 <sup>4</sup>	5,88.10 <sup>3</sup>	250	22,7	8,47
	6	9,1.10 <sup>3</sup>	2,70.10 <sup>3</sup>	161	17,5	7,04
	8	5,26.10 <sup>3</sup>	1,72.10 <sup>3</sup>	117	14,7	6,32
	10	3,57.10 <sup>3</sup>	1,21.10 <sup>3</sup>	90,9	13,4	5,88
CINa BS 3928 (2)	2	7,14.10 <sup>4</sup>	1,54.10 <sup>4</sup>	357	27	10
	4	1,39.10 <sup>4</sup>	4,35.10 <sup>3</sup>	166	15,4	6,58
	6	6,49.10 <sup>3</sup>	2,17.10 <sup>3</sup>	105	11,5	5,5
	8	4,0.10 <sup>3</sup>	1,33.10 <sup>3</sup>	75,7	9,7	4,8
	10	2,63.10 <sup>3</sup>	862	57,8	9,0	4,4
SODA FLUORESCEIN NFX 44011 (3)	2	7,2.10 <sup>4</sup>	2,2.10 <sup>4</sup>	480	32	
	4	1,8.10 <sup>4</sup>	5,0.10 <sup>3</sup>	180	16	
	6	6,7.10 <sup>3</sup>	2,6.10 <sup>3</sup>	120	12	
	8	3,8.10 <sup>3</sup>	1,8.10 <sup>3</sup>	85	10	
	10	2,3.10 <sup>3</sup>	1,1.10 <sup>3</sup>	70	9	

(1) Collision atomizers ; methane flame

(2) Dautrebande atomizers ; hydrogen flame

(3) Collision atomizers + separators ; fluorescence

Figure 1 - Decontamination factors of different filter papers

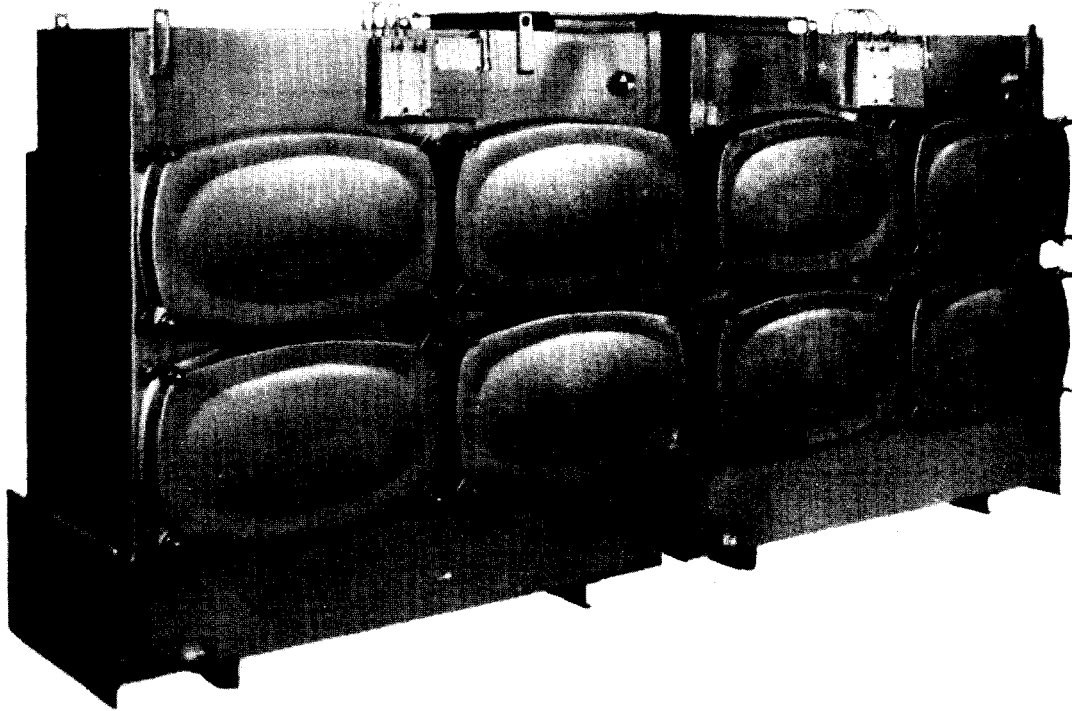

Figure 2 - Filter elements in metal casings with side outlets



Figure 3 - Wall type filter element

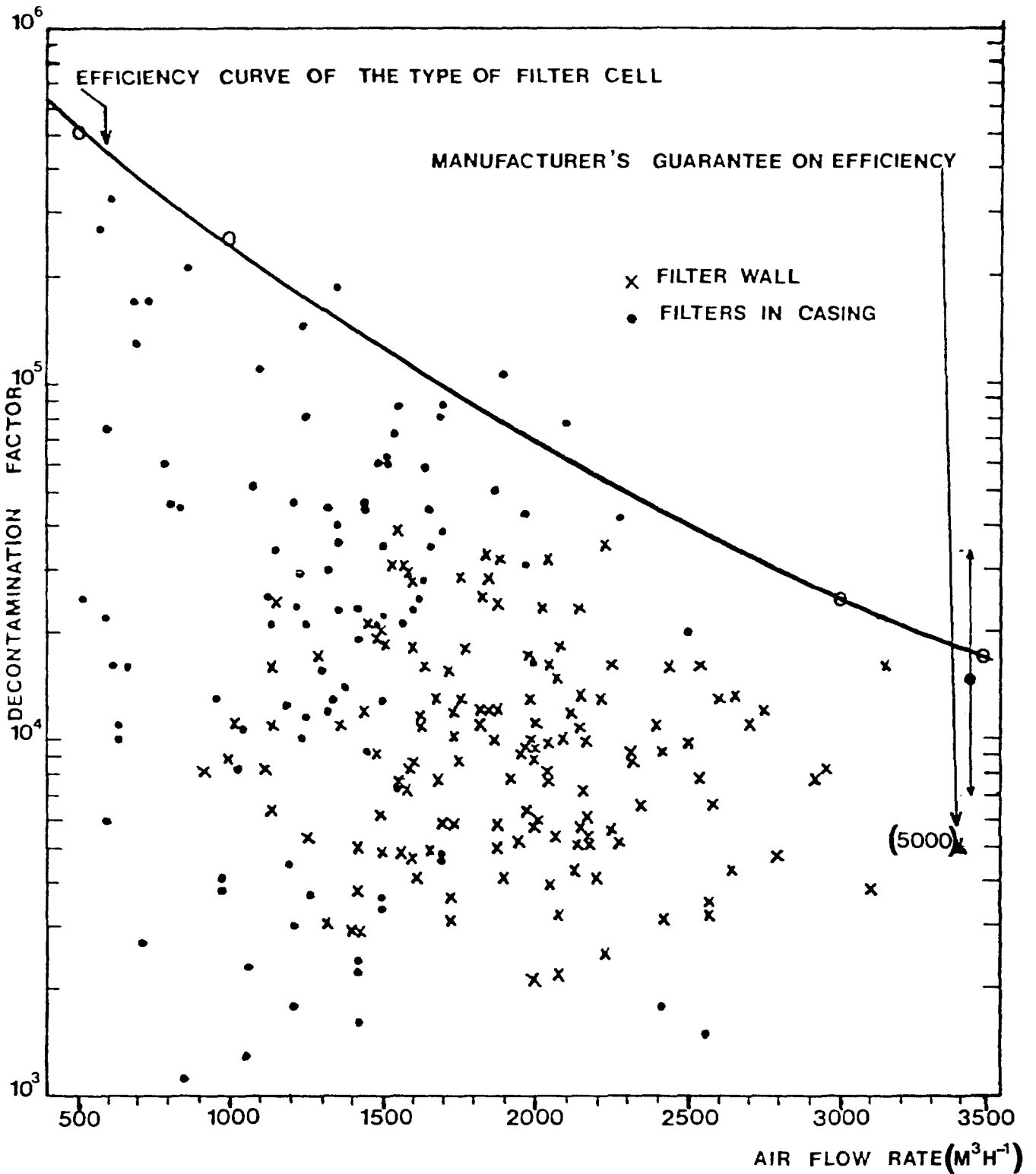

Figure 4 - In situ efficiency of cleaning systems for 17 PWR nuclear reactors, measured by the soda fluorescein method using 0.15 micron aerosol (AFNOR Standard NFX 44 011)

17th DOE NUCLEAR AIR CLEANING CONFERENCE

N°	Circuit Function	Decontamination factor		$R_1 = \frac{CE_1}{CE_2}$	$R_2$
		$CE_1$ 1981	$CE_2$		
1	peripheral rooms	3 700	1 900	1,95	1,95
2	peripheral rooms	5 300	2 200	2,41	2,41
3	fuel building	8 800	3 100	2,84	1,35
4	peripheral rooms	15 300	3 900	3,92	1,91
5	peripheral rooms	22 500	3 100	7,26	7,26
6	nuclear aux. building	25 300	6 200	4,08	1,81
7	site building	16 400	3 200	5,12	3,15
8	site building	7 400	3 800	1,95	0,82
9	peripheral rooms	7 600	5 900	1,29	1,04
10	fuel building	27 000	1 700	15,9	10,8
11	peripheral rooms	32 500	2 700	12,0	12,0
12	peripheral rooms	19 100	7 400	2,60	2,58
13	fuel building	22 400	2 200	10,2	8,96
14	reactor building	7 500	3 600	2,08	1,63
15	reactor building	5 100	2 900	1,76	1,08
16	nuclear aux. building	26 600	4 900	5,43	5,32
17	fuel building	3 700	4 400	0,85	0,26
18	site building	5,4	400 000		
19	site building	1,2	90 000		
20	site building	3 900	13 900		
21	site building	2,3	$2,4 \cdot 10^6$		

Figure 5 - Variation of the efficiency of prototype PWR cleaning systems (in situ control by the soda-fluorescein aerosol method - AFNOR standard NFX 44 011)

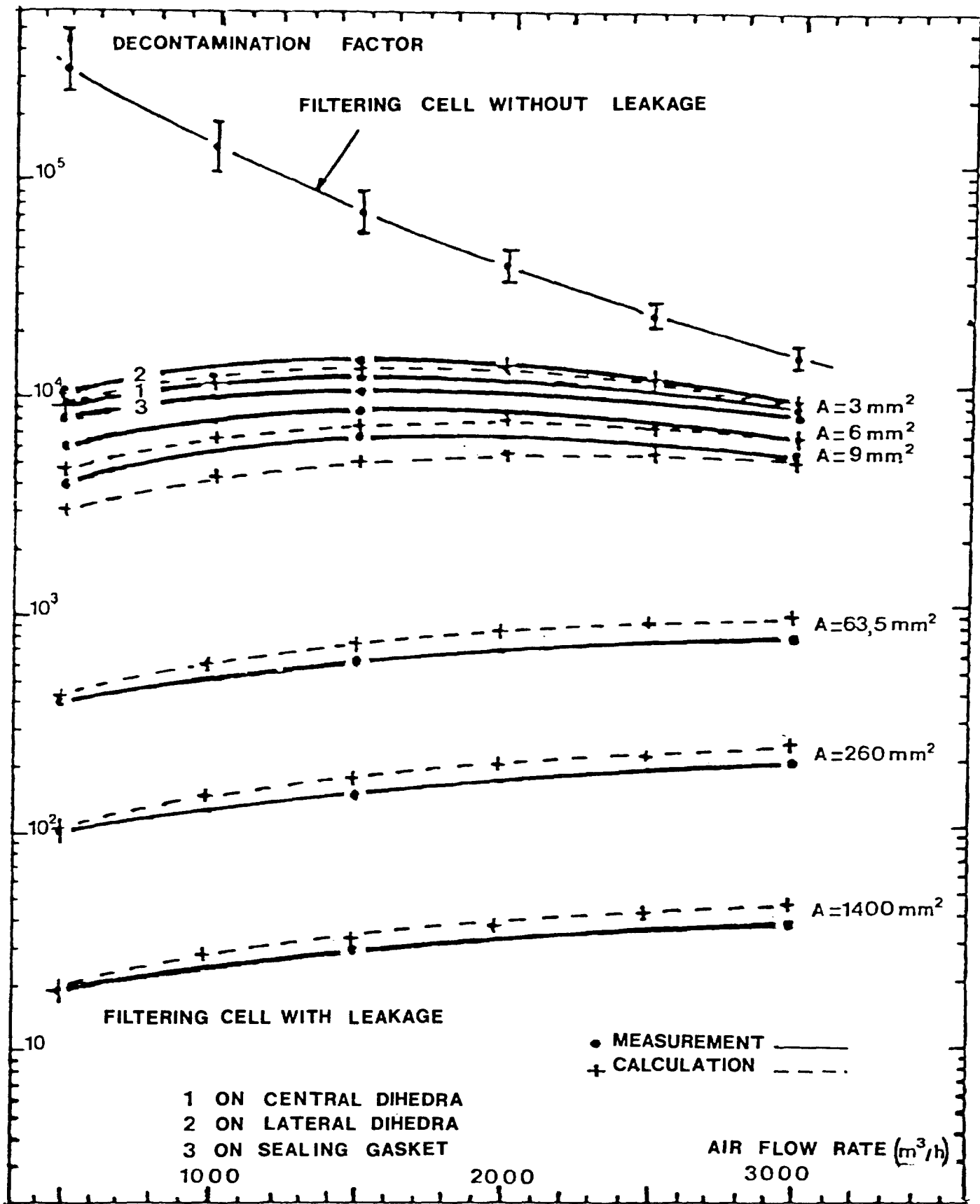

Figure 6 - Efficiency of 610 x 610 x 292 mm filter cell with and without leakage. Control with soda fluorescein 0.15 micron aerosol



	December 1978			September 1979			September 1980			October 1981		
	Decontamination factor	Pressure drop mmCE	Air flow rate $m^3.h^{-1}$	Decontamination factor	Pressure drop mmCE	Air flow rate $m^3.h^{-1}$	Decontamination factor	Pressure drop mmCE	Air flow rate $m^3.h^{-1}$	Decontamination factor	Pressure drop mmCE	Air flow rate $m^3.h^{-1}$
A	7 800	17	27 000				13 000		18 000	9 400	19	23 000
B	9 600	20	13 000				13 500		9 800	47 000	16	9 800
C	1 600	18	7 200	2 000	20	8 100	1 600	20	6 200	1 700	22	6 000
D	2 600		43 700	4 400		56 000	5 200		54 300	6 700		55 000
E	4 700	31	19 600				8 400	35	17 200	13 400	39	16 200
F				30 000	47	7 300	52 200	76	6 300	52 000	91	6 000
G	1 500	50	8 700	2 300	54	8 400	1 800	83	8 500	430	160	6 700

Figure 7 - Variation in cleaning system efficiency depending on filter loading (in situ control by soda fluorescein aerosol method - AFNOR Standard NFX 44 011)

DISCUSSION

DYMENT: What techniques are used to locate faults in filter systems?

DUPOUX: The DOP method was used for only some of the 15 systems out of 200 that had a decontamination factor less than, or near, 1,000. For the rest of the 15 systems, our observations were sufficient because the decontamination factor was very low.

KOVACH, J.L.: On Figure 7, you show constant pressure drop for several systems but, a decrease of flow occurs. Would this indicate incorrect fan design (e.g., sizing) which results in a decreasing flow rate but constant pressure drop?

DUPOUX: I don't know, but one might think so. We have encountered many differences in air flow rate between acceptance tests and routine tests.

PRATT: Test rig results suggest that at relatively high pressure drop the filter can begin to lift off its seat. Is this a possible reason for the drop in DF for the system of Figure 7?

DUPOUX: I don't think so, but in comparison with laboratory tests it is not excluded. It is perhaps the effect of the amount of pressure drop (150 mm ce), but it is not realistic to give a conclusion with one result and for a system where the initial decontamination factor in 1978 was only 1500. We hope to obtain another result by testing system F in September 1982. It still had a pressure drop of 91 mm ce in October 1981 and had an initial decontamination factor as high as 30,000.

## 17th DOE NUCLEAR AIR CLEANING CONFERENCE

### AIR CLEANING PHILOSOPHY IN A NUCLEAR MATERIALS FABRICATION PLANT

F. Y. Ward - R. E. Yoder  
Rockwell International  
Rocky Flats Plant  
P. O. Box 464  
Golden, Colorado 80401

#### ABSTRACT

At the Department of Energy's Rocky Flats Plant there is a major ventilation improvement project underway. To achieve the desired goals of "ALARA" regarding radioactivity and toxic material releases and natural phenomena insults, a comprehensive air cleaning philosophy and policy statement was developed. Design of the upgraded systems were evaluated against these statements and we believe that upon completion of the projects that an efficient system will be demonstrated. The design permits reuse and heat recovery of ventilation air, the optimization of sampling points to reduce analytical laboratory services. This paper discusses the basis of the philosophy and the engineering features incorporated to meet this stated objective. Points of compromise are noted.

#### I. INTRODUCTION

The original facilities at Rocky Flats were constructed and placed in operation in the very early 1950's. The air cleaning systems of those early facilities were compatible with the known hazards of that time.

In the intervening years, and as our knowledge of the hazards increased, it became evident that a comprehensive air cleaning philosophy and policy was needed. A policy which would provide a consistent and uniform approach to analysis, design and construction of air cleaning systems.

In the early years, the air cleaning systems, for new facilities were analyzed, designed and constructed to meet specific requirements. As a consequence, there was a lack of uniformity and consistency from one system to another. For this reason, it was necessary to review past practices. In so doing we found there was an entire spectrum of conditions that should be addressed and analyzed during planning, design and construction of air cleaning systems.

The public interest in the Department of Energy's Rocky Flats Plant is continuous and the public expectation is that operating systems meet the latest in technology. This interest is expressed

## 17th DOE NUCLEAR AIR CLEANING CONFERENCE

in public meetings and it is necessary to be able to present documentation of programs, practices and performance so that objective evaluations can be conducted. The design and operation of ventilation systems is important in this arena because their integrity permits a degree of public confidence that no, or only a minimum, radiation exposure can result from the operation of the plant. Our intention is to design and operate all air cleaning systems to meet these expectations. The design requirements stated in this paper have met these public as well as operating requirements.

Therefore, in July 1978 Rockwell International, Rocky Flats Plant issued the following General Building Air Cleaning Policy:

It is the policy of the Company to conduct its operation in conformance with the Department of Energy's "As Low As Practicable" exposure to personnel guideline and in a manner that assures that every person on the Rocky Flats Plant site or the populace outside Rocky Flats boundaries shall not be subjected to an environment that is in excess of approved exposure limits for toxic materials.

With this policy, it is now possible to generate an air cleaning philosophy:

Ventilation air or air exhausting to atmosphere shall not contain the following in excess of applicable limits and/or guidelines.

1. Toxic, noxious, or explosive vapors or gasses.
2. Objectionable odors.
3. Toxic and radioactive particulates.

Air from the following sources shall not be recirculated.

1. Air exhausted through "hoods" (laboratory hoods, machine hoods, etc.)
2. Air that has been "scrubbed" for the removal of toxic vapors, gases, mists or odors.
3. Air containing toxic vapors, gases or odors.
4. Air from toilet rooms.
5. Air from locker and shower rooms.
6. Air that contains toxic or radioactive particulate in excess of applicable limits and/or guidelines (after filtration).

## II. DISCUSSION

Air cleaning in itself is not particularly difficult, especially since the technology for cleaning air is well established

## 17th DOE NUCLEAR AIR CLEANING CONFERENCE

What is difficult, however, is knowing how clean the air is or should be prior to discharge. The larger the volume of air being cleaned, the greater the problem for assuring clean air. In its most simplistic form, air cleaning is a matter of passing the air through an appropriate air cleaning device to remove the contaminants. Knowing how clean the air is, is a matter of sampling the cleaned air and analyzing the samples for contaminants and then relating the contaminants to the volume of air cleaned. It is, therefore, obvious that, regardless of how efficient or inefficient the air cleaning equipment is, if the air sampling and volume measurement are inadequate then it is impossible to determine system performance and air quality.

A comprehensive review of the air cleaning philosophy and practices at Rocky Flats was conducted in 1970. This review was necessitated by the addition of new process facilities and the desire to achieve "state-of-the-art" air cleaning for the new facilities as well as providing a baseline for the upgrading of the older facilities.

As a result of this review, the following were analyzed and incorporated into the new facility.

### 1. Modular Filter Banks

Rather than one large filter plenum several small, modular filter plenums were utilized. The major advantage in this type of construction is:

- a. In the event of fire, the fire could be contained within the effected module without damage to adjacent module.
- b. Routine maintenance of filters, fans, fire suppression devices, instrumentation and testing can be accomplished in the filter modules, with minimum interruption to building operations.
- c. Air flow could be reduced, from non critical areas, during off shifts, weekends and holidays for energy conservation.

### 2. Testable Filters

A means for testing each filter and each filter bank was assured.

### 3. Redundancy

To assure continuous operation and maintainability, stand-by fans, dual control circuitry and certain stand-by instrumentation was provided.

## 17th DOE NUCLEAR AIR CLEANING CONFERENCE

The control circuitry was installed in separate conduits routed so that one accident could not damage both conduits.

### 4. Emergency Power

The control circuits, fans, instrumentation and certain lighting, for each module, was connected to the emergency generator. A sequence panel controls the sequence of restart, the most critical modules having priority over the less critical.

### 5. Maintenance

For ease of maintenance, the height of the filter banks was restricted to four high. This permitted filter changing without the use of scaffolding. Also, the distance between filter stages was increased to allow for free movement of maintenance personnel.

### 6. Air Sampling

Air sampling was included in the system design. Features incorporated included minimum effluent sample points, redundant sampling points, velocity profilers and flow straighteners.

### 7. Fire Protection

All filter banks are protected with automatic and manual fire sprinkler systems. These systems are supported by dedicated water storage and supply.

In 1977, planning for major modifications to the ventilation systems in five older facilities was initiated. During the review of the air cleaning systems in these five facilities, it was found that no two systems were designed and constructed with a common air cleaning philosophy.

It was apparent that a general plant policy and guidelines was needed so that, regardless of the final physical configuration, all air cleaning systems would be planned, designed and constructed to the same philosophy.

The Department of Energy issued a requirement that radioactive operations be conducted under the ALARA (As Low as Reasonable Achievable) concept. This concept must be applied to both workers and the public. In the activities at the Rocky Flats Plant, this philosophy has included also the minimization of exposure to non-radioactive materials which requires the optimization of protective techniques. The demands of energy conservation at a time of high public concern over workplace health has required a delicate balance between safety, conservation and cost. The statement of

## 17th DOE NUCLEAR AIR CLEANING CONFERENCE

what is reasonable at Rocky Flats may not coincide with the requirements at another installation. ALARA has no stated performance specification, therefore, objective professional judgment will be required in many instances. This ventilation policy was developed to provide design latitude while achieving reasonable state-of-the-art protection to workers and the public during normal and accident conditions.

### 1. Energy Conservation

Major energy conservation could be accomplished in several ways.

- a. Recirculation of air, after filtration, from offices.
- b. Reduce number of air changes to minimum during off shifts, weekends and holidays.
- c. Utilization of high efficiency motors and variable drives.
- d. System analysis to reduce pressure drop wherever possible.

### 2. Improve Technical Understanding

- a. Compare existing design with current requirements.
- b. Evaluate available instrumentation for control measurement, air sampling, recording and alarms.

### 3. Major Up-Grading of Existing Facilities

Review any air cleaning equipment or system that is connected to or associated with major modifications, during the planning stages of such modifications, whether or not the air cleaning equipment would or could be effected by the modification.

The buildings at Rocky Flats are classified into three broad categories.

1. Non-Plutonium Handling-Process Buildings.
2. Plutonium Handling-Process Buildings.
3. Administration and Support Buildings.

## 17th DOE NUCLEAR AIR CLEANING CONFERENCE

The air cleaning philosophy for these categories are as follows:

1. Non-Plutonium Handling-Process Buildings
  - a. Ventilation air exhausting directly to atmosphere shall be filtered through not less than two (2) stages of HEPA filters.
  - b. Recirculated office ventilation air shall be filtered through not less than one (1) stage of HEPA filters.
  - c. The building ventilation air systems shall be designed so that the building internal pressures shall remain negative to the atmosphere.

The ventilation air shall flow from clean zones to potentially contaminated zones to probable contaminated zones.
  - d. The buildings shall be designed for use of filters in the ventilation air intake plenum. The types of inlet air filters shall be based on the mission of the building, except that buildings designated as "clean air" shelters shall be designed for one (1) stage of Aerosolve 95 filters in the intake plenum.
  - e. Air flow measurements shall be as accurate technically and operationally feasible.
  - f. The number of discharge points shall be limited to an absolute minimum (one discharge point is ideal).
  - g. Air samples shall be taken at each discharge point. Care shall be used to assure representative samples.
2. Plutonium Handling-Process Buildings
  - a. Ventilation air exhausting directly to atmosphere from plutonium buildings shall be filtered through: (1) two-stages of HEPA filter for offices, halls and modules; or (2) four-stages of HEPA filters from gloveboxes.
  - b. Recirculated ventilation air in plutonium handling buildings shall always recirculate through two stages of HEPA filters.



## 17th DOE NUCLEAR AIR CLEANING CONFERENCE

### c. Storage Areas

- (1) Air from plutonium storage areas, "Material in Process" shall be exhausted through not less than four (4) stages of HEPA filters.
- (2) Air from plutonium storage areas, "Finished Product-Packaged for Shipment," shall be exhausted through not less than two (2) stages of HEPA filters.
- (3) Air from storage areas for materials having Low Specific Activity (LSA) shall be exhausted through not less than two (2) stages of HEPA filters.

- d. The building ventilation air systems shall be designed so that the building internal pressure shall remain negative to the atmosphere.

The ventilation air shall flow from non-radioactive zones, to potentially radioactive zones, to probable radioactive zones.

- e. The building ventilation air intake plenum shall be designed for one (1) stage of HEPA filters.

### 3. Administration and Support Buildings

Ventilation air for buildings whose basic functions are office, storage, warehousing, garage, library, shops, etc., shall be designed in accordance with ASHRAE Standards for ventilation.

Buildings in this category designated as "clean air" (or fallout) shelters shall be designed for one (1) stage of Aerosolve 95 filters in the intake plenum.

To show the application of this philosophy we are presently incorporating the design into Building 883 which is typical of a Non-Plutonium Handling-Process Facility. (Figure 1) The air cleaning system in this facility is undergoing major modifications. These modifications, when complete, will be in accord with present air cleaning philosophy. Note the incorporation of sampling devices, velocity profilers, air straightening vanes, location of filter plenums, etc. For specific design requirements, the

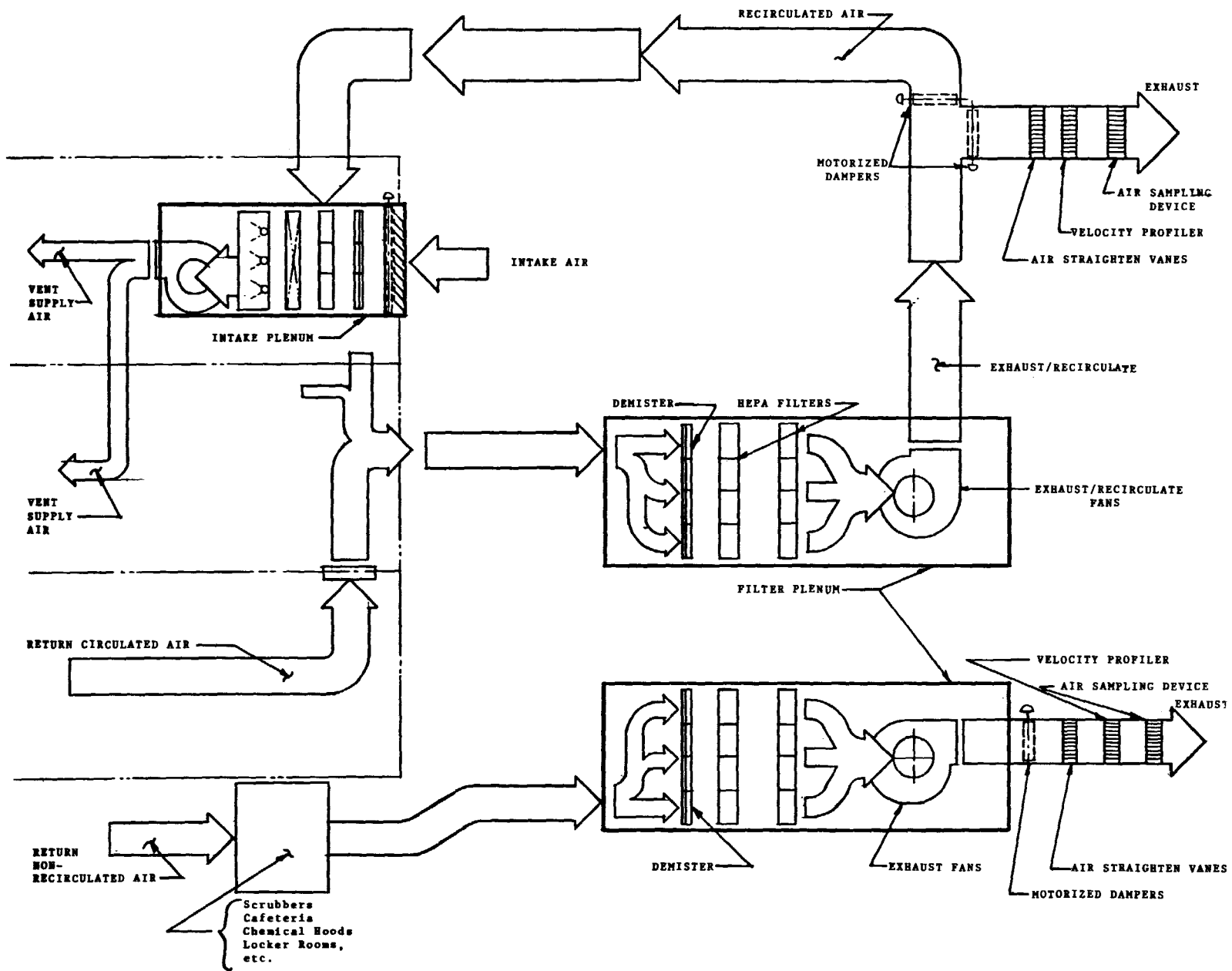

AIR CLEANING SYSTEM  
TYPICAL

## 17th DOE NUCLEAR AIR CLEANING CONFERENCE

American Society of Heating, Refrigeration and Air-Conditioning Engineers (ASHRAE) "Handbook of Fundamentals."

American Conference of Governmental Industrial Hygienists (ACGIH) "Industrial Ventilation."

Energy Research and Development Administration (ERDA) "Nuclear Air Cleaning Handbook."

ERDA Manual Appendix 6430 "Facilities General Design Criteria."

### CONCLUSION

We conclude that the design practices incorporated in the review of the 1970 design criteria were basically sound. The addition for requirements for energy conservation and ALARA necessitated some changes for their inclusion. The incorporation of these changes does not compromise overall system effectiveness but allows the application of new design initiatives.

### DISCUSSION

PRATT: Is it possible to postulate accident conditions that will result in pressurization of the building containment because of the use of a blower on the input air?

WARD, F.Y.: Accident conditions can be postulated which will pressurize the building. However, its design redundancy and interlocks have proven effective in eliminating this concern.

BURCHSTED: To where is air from process facilities recirculated and what is the pressure drop between building or process areas outside and between adjacent areas?

WARD: Process air is not recirculated but office air may be recirculated to office areas. Pressure drop from atmosphere to most negative areas is about 0.5 in. w.g. Adjacent areas have a 0.1 in. w.g. minimum differential.

ETTINGER: Could you give us some of the rationale for selecting two HEPA filters for some components of recirculation and four HEPA filters for others? Was there a cost-benefit or risk-benefit analysis made to pick those numbers, or were they arbitrarily chosen?

WARD: I wouldn't say that they were arbitrarily chosen. We looked at a couple of things: one, if we were changing a single stage of HEPA filters in a contaminated area we would have no protection downstream. Therefore, we needed to provide a second stage of HEPA filters to give us some sort of protection in the more critical areas. It has been so long ago since we came up with the four HEPA filter stages, that I am not sure just how we arrive at it, even though I was the project engineer on the facility at the time it was done.

## 17th DOE NUCLEAR AIR CLEANING CONFERENCE

FREIBERG: On two stages versus four stage, when we had the fire in 1969, we had one stage of HEPA filtration in the main plenum which didn't hold up at all. We very rapidly put up a second stage. This was general room air, not from the glove box systems or the high canyon areas. We found from a calculation of the large amount of plutonium we were handling (as much as 200 grams of plutonium per HEPA filter) that the amount that would penetrate, even at high efficiency rates, required a minimum of three stages to make sure that we were in the range of 0.06 microcuries. The reason we went to four is that there might be a possibility that we would have one bank under maintenance.

ETTINGER: Do you count, in the four stages, the filter after the glove box?

FREIBERG: The filter in the glove box is not counted. If we were to count it, there would be five. Throughout the entire system, the four stages are used only when we exhaust directly from the glove boxes or the canyons themselves. The air is not recirculated, it goes directly to the outside.

DYMENT: Concerning the decision to adopt recirculation and conserve energy, is this on a basis of cost effectiveness or on a national energy conservation policy? Is there any significant effect on overall safety?

WARD: There is a national energy conservation policy which requires exercise of cost effective measures to reduce energy consumption. There is no significant effect on overall safety if alternatives are carefully evaluated.

## 17th DOE NUCLEAR AIR CLEANING CONFERENCE

### SYSTEM OPERATIONAL TESTING OF MAJOR VENTILATION SYSTEMS FOR A PLUTONIUM RECOVERY FACILITY

F. J. Linck, Jr.  
Rockwell International  
Rocky Flats Plant  
Golden, Colorado

#### Abstract

In July, 1981 startup and testing was completed on the HVAC and Utilities systems for a major Plutonium Recovery Facility. This facility was constructed and tested under the Department of Energy's minimum criteria for new plutonium facilities. The facility itself, the testing involved and some of the major problems encountered are discussed, along with the solutions to those problems.

#### I. Introduction

Present DOE regulations regarding the startup and checkout of plutonium processing facilities now makes it necessary to certify those facilities in a manner very similar to that required for reactor facilities. The testing and demonstration of safety features is now a complex process. The experiences with starting and testing one such facility are outlined.

#### II. Discussion

In July, 1981 startup testing was completed on the HVAC and Utilities systems for a Plutonium Recovery and Waste Treatment Facility at Rocky Flats. The facility cost approximately \$215 million and consisted of three functional units: (1) a plutonium recovery facility, (2) a liquid waste treatment facility and (3) a supporting office, cafeteria and maintenance facility. The plutonium recovery facility and portions of the support facility which are critical to the operation of the plutonium recovery facility are to be discussed in this paper.

In order to give a better idea of the testing required, a brief description of the facility is necessary. All three functions share common services and it will be necessary to sometimes include all three in the discussion. The plutonium recovery facility and portions of the support facility are hardened against both tornadoes and seismically as noted below:

##### TORNADO:

134 m/s (300 MPH) Tangential winds  
11.7 kPa (1.7 PSI) Negative pressure

##### SEISMIC:

5.6 R Operating base earthquake  
6.0 R Design base earthquake

## 17th DOE NUCLEAR AIR CLEANING CONFERENCE

The hardened portion is a four level poured concrete structure. The remaining portion is prestressed concrete. The combined facility is approximately 24 m (80 ft.) high by 55 m (180 ft.) wide by 100 m (330 ft.) long. A few other statistics about the building are as follows:

- 33,800 m<sup>2</sup> (364,000 ft<sup>2</sup>) Floor area
- 169,000 m<sup>3</sup> (6,000,000 ft<sup>3</sup>) Volume
- 75 km (47 miles) Process piping
- 10 Process control rooms
- Over 560 m<sup>3</sup> (20,000 ft<sup>3</sup>) of Glovebox volume

A summary of the HVAC system statistics is as follows:

- 8 Systems moving 400 m<sup>3</sup>/s (850,000 CFM) of air
- 6,485 m<sup>3</sup> (229,000 ft<sup>3</sup>) of Inerted vault and gloveboxes
- 87 Room differential pressure controllers
- 1 Central Utilities control room
- 2,500 610 x 610 x 292 mm HEPA filters
- One 2,500 KVA Turbine driven emergency generator
- 3 Uninterruptible power supplies

The outer shell of the building has a four hour fire rating. The main interior walls separating processing areas have two hour fire ratings. Personnel exposure to radiation is reduced by performing most of the operations remotely from the process control rooms which are shielded from the process areas.

The hardened portion of the plutonium recovery facility has two ventilation systems which move approximately 280 m<sup>3</sup>/s (600,000 CFM) of air. A much simplified version of one of these systems is shown in Figure 1. Approximately 38 m<sup>3</sup>/s (80,000 CFM) of air is fresh air makeup. The remainder is recirculated through the basement mechanical equipment areas after passing through two stages of HEPA filtration. The recirculating air then mixes with outside air to be distributed throughout the building as supply air. Chemical and radioactive particulate monitors continuously check the effluent air quality and will alarm in the central utilities control room if anything is abnormal. Each ventilation sub-system is equipped with two fans and duplicate primary control loops for reliability. Valving on the exhaust ducting permits one exhaust filter plenum to act as standby for another. Both the supply and exhaust are equipped with isolation valves which can be closed if it is necessary to seal the building off from the outside. The exhaust isolation valves will also close automatically to a preset position to moderate the effects of the high velocities and negative pressures which can be caused by a tornado. The supply ductwork has heavy duty backdraft dampers for the same purpose.

The glovebox exhaust air from all of the "wet" gloveboxes, about 570 m<sup>3</sup> (22,000 CFM), is exhausted through scrubbers before it enters the filter plenums. Air vented directly off of the processes is passed through additional scrubbers before entering these main scrubbers. This provides one and two stages of scrubbing for air containing acid fumes.

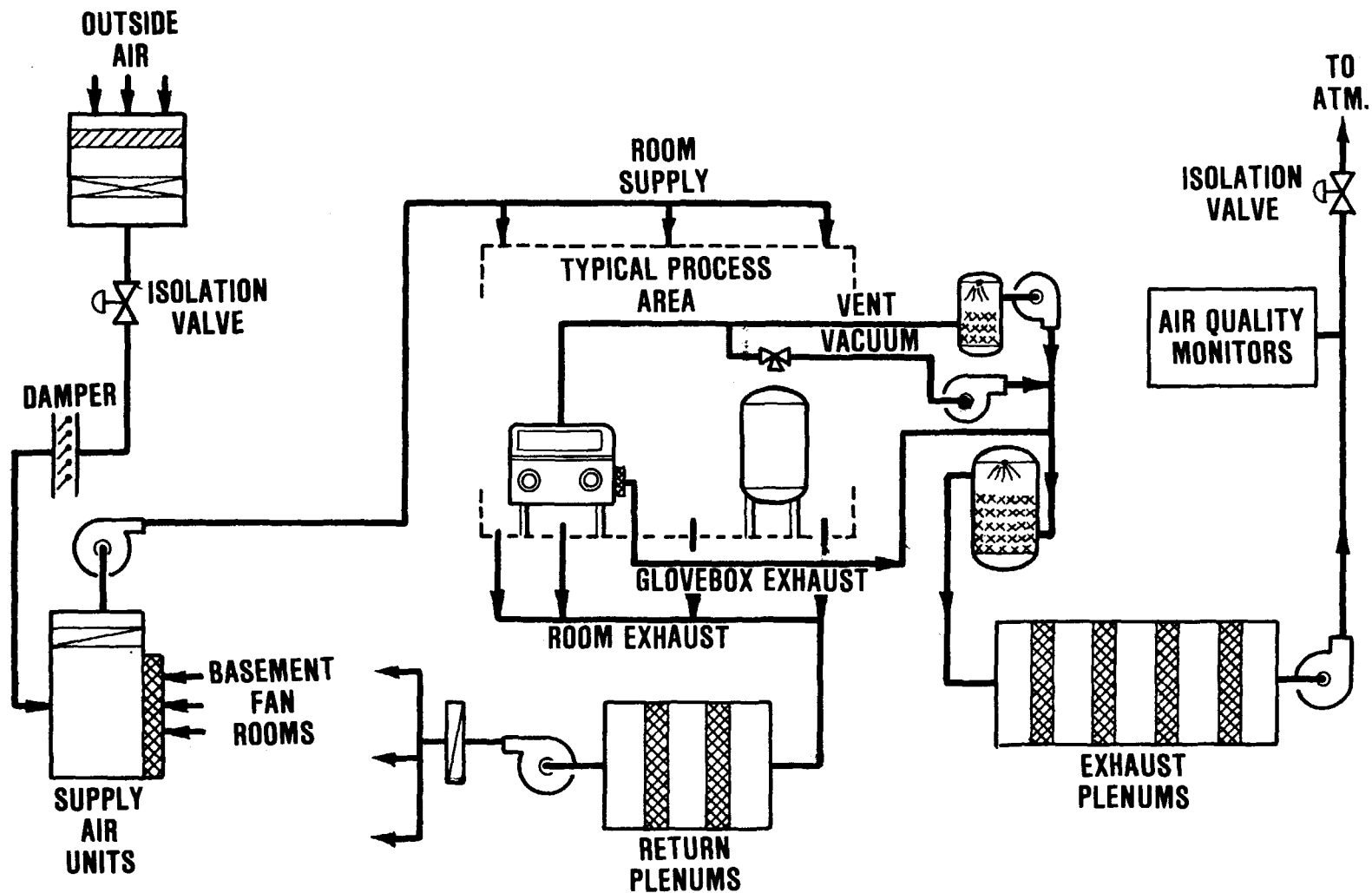

FIGURE 1. SIMPLIFIED VENTILATION SYSTEM FLOW DIAGRAM

## 17th DOE NUCLEAR AIR CLEANING CONFERENCE

Building pressures are controlled by controllers on the central control board to maintain the pressure zones shown in Figure 2. The pressures are monitored on the Data Acquisition System (DAS) and critical ones are alarmed if they deviate from acceptable limits. Air change rates are high in the mechanical equipment areas (about 10 air changes per hour) to remove the heat generated by the equipment, particularly the ventilation fans. Air change rates are high in the process areas (about 15 air changes per hour) to remove chemical fumes or minimize the spread of contamination in the event of a glovebox breach. Air change rates in the gloveboxes are even higher (30 air changes per hour) to remove chemical fumes, to remove heat generated by equipment, or to prevent the buildup of moisture in the gloveboxes whose operations are sensitive to excessive moisture.

A large nitrogen atmosphere storage vault, shown schematically in Figure 3, and several nitrogen atmosphere gloveboxes use recirculated nitrogen for ventilation. This "inerted" system maintains oxygen levels to less than 5% by bringing in pure nitrogen from an on site nitrogen plant as needed to compensate for in-leakage air. Although no attempt is made to dry the recirculating gas, it remains dry because of the dryness of the fresh nitrogen and the limited amount of moisture infusion.

### Startup Testing

The initial testing was divided into two phases:

1. Testing not requiring operation of equipment was considered as construction component, or "CC" testing and was performed by the construction contractor. Examples of this type of work are leak testing, pressure testing, and continuity checking. This work was witnessed by both Rockwell and the architect-engineer.
2. Testing requiring the operation of equipment was considered as system operation, or "SO" testing and was performed by Rockwell with the architect-engineer witnessing the tests.

The tests of the HVAC and Utilities were written by the architect-engineer and reviewed by Rockwell and DOE. Testing of the process equipment was developed and performed in a different manner.

The HVAC and Utilities for the entire three-function facility included the 8 ventilation systems and nitrogen recirculating system mentioned before, a vacuum system, process vent system, heating hot water and several chilled water and cooling water systems. These systems had 39 SO tests involving over 1,000 pages of test instructions and data sheets. Preliminary operating procedures were completed by this time and these were used along with the instructions in the tests to start the systems. Where deviations were required from normal startup procedures or system modifications



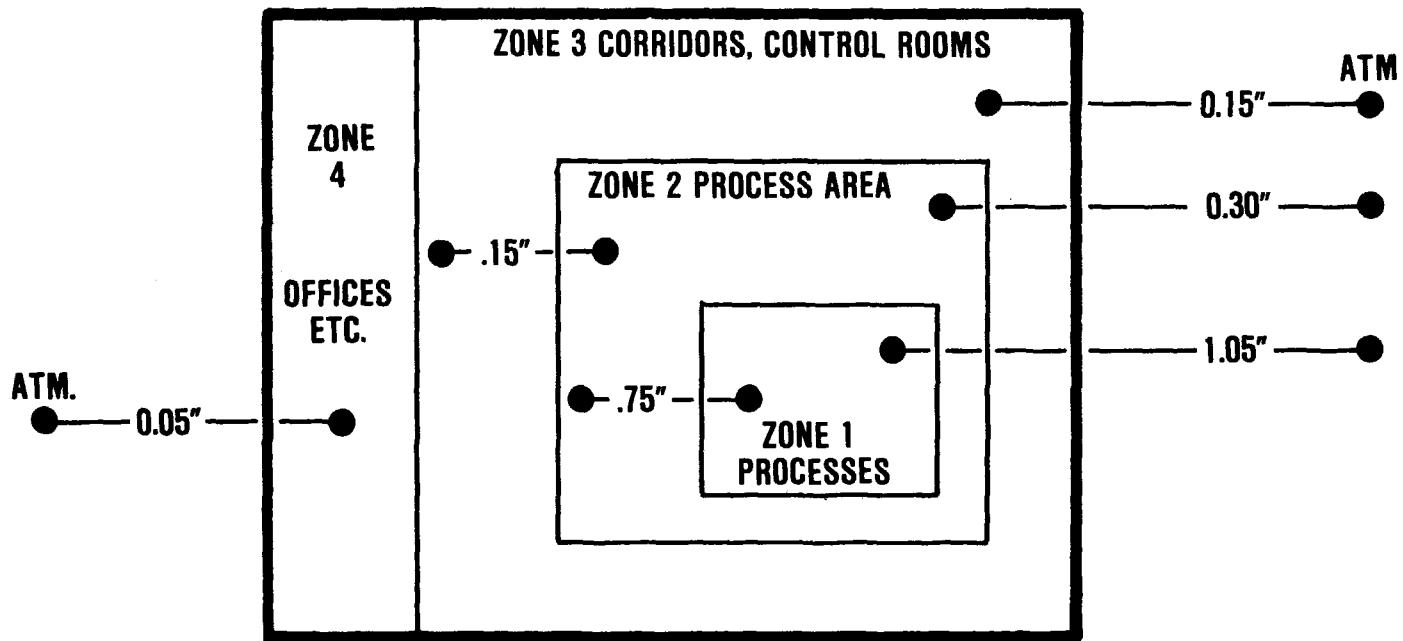
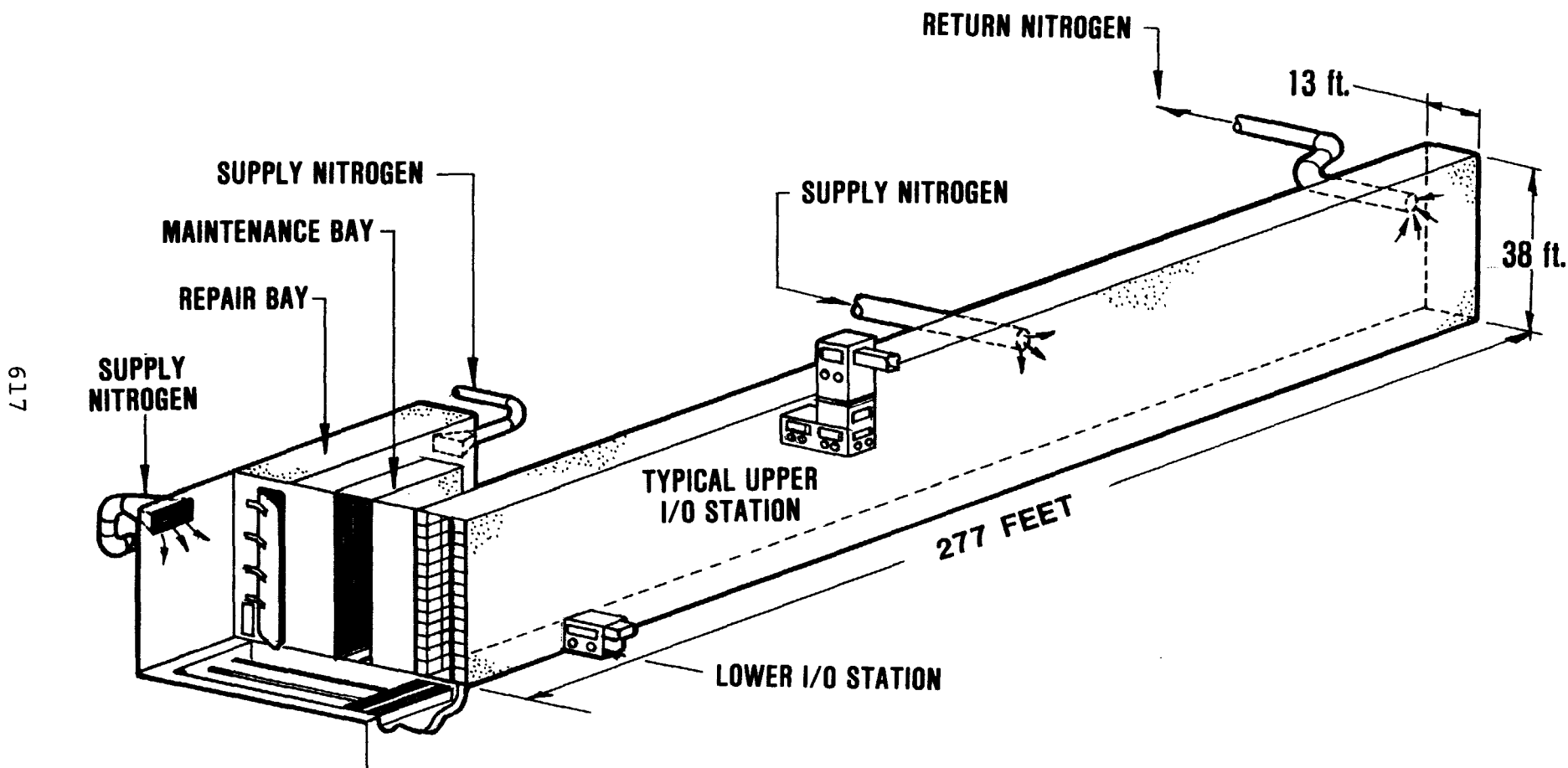

FIGURE 2. BUILDING PRESSURE ZONES

**EIGHT INPUT/OUTPUT (I/O) STATIONS  
210,000 FT<sup>3</sup> OF VAULT SPACE  
FIVE AIR CHANGES PER HOUR**



617

17th DOE NUCLEAR AIR CLEANING CONFERENCE

**FIGURE 3. CENTRAL STORAGE VAULT**

## 17th DOE NUCLEAR AIR CLEANING CONFERENCE

necessary to install temporary measuring equipment, the changes were given in the tests.

The systems were started as they became available from construction. Testing was complicated by the condition of having to start some systems, such as ventilation, prior to completion in order to support construction. In these cases, testing had to be staged or deferred until the entire system was completed.

Testing of the HVAC systems involved checking fan performance, proper controller operation and valve sequencing, heating and cooling coil balancing, air balancing for the various operating modes, and checkout under abnormal and emergency power conditions. The air balancing turned out to be exceptionally easy for such complex systems because of built-in air flow measuring devices and the capability of having the supply and exhaust systems under control of the controllers while balancing. Flow and pressure capabilities were checked as were vibration checks on all rotating equipment. The instrumentation and controls and all safety interlocks, along with all system alarms were also checked. As deficiencies were found, the systems were turned back to construction for correction. In some cases, this stopped the testing on a particular system for several weeks until corrections could be made. All startup testing on the hot and cold water systems was done with water containing corrosion inhibitors.

Following the testing and deficiency correction, the equipment was put into "cold" operation at which time the process chemicals were added (potassium hydroxide solution in the case of the scrubbers). This phase of testing checked for proper materials of construction and proper operation under actual density and viscosity conditions. Glass prefilters were temporarily installed in the HEPA filter plenums to collect construction dirt before the HEPA filters were installed. Based on in-place testing results, approximately 0.5% of the HEPA filters were replaced in the filter plenums containing stainless steel framework, 2.5% of the filters had to be replaced in the plenums containing painted steel framework. Re-testing of the rejected filters at the Q.A. Test Station showed that no more than a third of them had been damaged. The conclusion was reached that the leakage was at the gasket-frame sealing surface and the stainless steel frames were much better than the painted frames.

### Final Testing

Final testing involved an "Integrated Operational Test" which integrated the various systems into one unit by testing the entire building as a single entity. This test demonstrated the interaction between systems by interrupting portions or all of the various supporting utilities as well as the HVAC systems themselves. The test was actually a series of tests involving interrupting the tower water system operation and the building electric power in varying degrees. The various cooling systems as well as plant air and instrument air were shut down. The emergency generator was tested as well as shut down. The ventilation systems were put into their off-normal and emergency operating modes. The emergency ventilation for the Incineration system was tested and the building isolation

## 17th DOE NUCLEAR AIR CLEANING CONFERENCE

valves were completely checked through their operating and failure conditions. This testing was witnessed by Rockwell management and Safety personnel, by the architect-engineer and by DOE operational safety personnel. The tests were done in phases so any problems encountered in one phase could be corrected and retested in a later phase.

During the latter part of the construction work, while the SO testing was proceeding, plant personnel and DOE personnel were running periodic safety surveys. Concurrently with the "Integrated Operational Test" the results of the corrective actions taken as a result of those surveys were reviewed. Items which had become questionable were checked out during the final testing. A few examples of this are:

1. Making certain the building PA system would operate during a total power outage. (Emergency generator off line)
2. Checking the filter plenum fire protection system and its alarms during a total power outage.
3. Checking the exhaust air monitor alarms during a total power outage.
4. Checking the battery life and automatic switching of the Uninterruptible power supplies.

### Problems Encountered

A large number of deficiencies and problems were found as would be expected in a facility of this complexity. Some of the more significant of these are described below:

1. Supply System Windup. The individual room pressure differential controllers would respond to a change in room pressure whenever a door was left open. The damper operators on the ventilation to each process room were split range so the loss of air pressure in the room would cause the supply damper to close and the exhaust damper to open. The reduction in air supply to the room would be sensed by the supply air flow controller and it would respond by opening up the fan vanes. This would unbalance other areas which in turn would close down their supply dampers until the fans were running wide open and the process rooms and their dampers shut. Control rooms and corridors which had no automatic dampers on their supply would be highly pressurized.

This problem was solved by converting the supply air flow controllers to control discharge pressure in the main supply header. The pressure was set to give the correct air flow with the system balanced. The upset of one or more rooms would then not disturb the system.

## 17th DOE NUCLEAR AIR CLEANING CONFERENCE

2. Split Range Damper Oscillation. The damper operators mentioned above had split operating ranges of 20 to 62 kPa (3 to 9 PSI) for the exhaust dampers and 62 to 103 kPa (9 to 15 PSI) for the supply dampers. The narrow range provided so much mechanical feedback to the pilot positioner that the dampers would break into oscillation at any time.

The problem was corrected by installing restricting orifices in the pilot positioners to slow down their response.

3. Wrong Range Actuators Installed. The wrong range actuators were installed in many locations. Rather than change the actuators, it was found easier to change the range springs in the pilot positioners to get the right range actuator on a given damper.

A project is now in process to convert nearly all of the split range control systems to full range. This will eliminate all of the above problems and give better system reliability by eliminating about half of the damper operators.

4. Inert System Pressure Controls. The original control system was a complex cascading system involving the system pressure, oxygen level and makeup nitrogen flow. In addition, system pressure control was attempted using large butterfly valves in the recirculating nitrogen stream. The control system was unstable and in addition, the large valves could not approach the degree of pressure control required.

The entire control loop was modified to eliminate the interaction which caused the instability and to transfer pressure control to a small valve which could provide the necessary accuracy.

5. Low Range Pressure Transmitter Problems. The low range pressure transmitters used to control the room pressures were found to be drifting and shifting zero. These transmitters were a force-beam type and after considerable testing were found to be unacceptable. The mechanical linkages would not permit the degree of accuracy necessary. The transmitters were very susceptible to vibration.

New solid state variable reluctance transmitters were used to replace all of the original low range units. These new units had the additional advantage of being available in lower pressure ranges than the original ones.

6. Valve Leakage. Butterfly valves were installed incorrectly causing tearing of the liner on operation. Construction personnel were cautioned as to the proper way to install the valves. Those already installed were removed and repaired as the damage was discovered.

## 17th DOE NUCLEAR AIR CLEANING CONFERENCE

7. Leaking Instrument Pressure Sensing Lines. Very small leaks were discovered in many of the sensing lines. These leaks were almost undetectible but gave false pressure and flow readings.

All flow and pressure instruments had to be checked to make certain they were reading correctly and if not, the problem corrected.

8. Ductwork Cracking. Vibration, especially downstream of the fan discharge caused the ductwork to fatigue and crack. This occurred despite the fact the ductwork had been designed to high velocity duct standards.

The bad sections were replaced and the new sections were externally reinforced with angle iron.

9. Scrubber Problems. Caustic scrubbers are used to scrub the air from wet glovebox operations to remove the acid fumes. The scrubbers were designed for normal operations but not for any upset conditions:

- a. Foaming from excess caustic causes the release of contaminated water to the room.
- b. The domestic water is used to replace scrubber water evaporated into the air stream. This water is saturated with calcium from the water treatment system. The calcium scales out in the recirculating pump unless blowdown is kept high.
- c. Caustic addition is automatically controlled by pH controllers. The pH probes fail frequently and the system goes acid. The acid then attacks the black iron piping. When proper pH is restored, the rust plugs up strainers and damages the pump bearings.

The scrubbers should have been designed to handle upset or abnormal conditions. Procedural changes have been made to temporarily compensate for most of the problems. Several modifications to the equipment have been made and more are planned to permanently correct the deficiencies.

### III. Conclusions

The plutonium recovery and waste treatment facility was the largest such facility started and tested at Rocky Flats. The testing was more severe than any other done at this plant site. A large number of problems and deficiencies were found and corrected. The few which remain have been compensated for by changing procedures in a manner which does not affect the facility safety. All system safety checks including the "Integrated Operational Test" were successfully performed. The facility HVAC and utility systems are now supporting the building production operations.

DISCUSSION

PAULING: Has your design of the air intakes, including the air intake filters, considered airborne volcanic ash?

LINCK: No. We have had a concrete aggregate plant nearby which went into operation several years ago. It is now closed down but for quite a long time before and after that plant went into operation we ran air samples and found that airborne dust caused by the high winds at Rocky Flats produced a lot more dust than did the aggregate plant. I suspect that the same thing would be true of the volcanic ash although it would possibly be finer. We do not get a tremendous amount of dust during high wind conditions that we have to worry about. Our prefilters will take care of it. Because of the effectiveness of the prefilters, we haven't noticed any significant loading of the supply HEPA filters from this source.

ANON: In France, some believe that when we change the filters there can be a transfer of plutonium that was initially deposited on the dirty side to the downstream. Has any one information about such a transfer when filters are changed, and, if yes, a solution?

FREIBERG: We change many, many thousands of HEPA filters every year. We have a filter changing crew consisting of about 24 people that do nothing but change filters. They use a clamping device, now designed into the filter plenum, that completely blanks-off the downstream side of the filter from the downstream duct. When they change a filter, they seal it and clean the blank-off completely before they put the new filter in place. It works well. We do not now see, as we did in the past, and as France now experiences, increased contamination on the downstream side. At the 13th Air Cleaning Conference there were five or six papers presented by Rocky Flats that included an explanation of why two and four filters are used. These papers also included the clamping devices that we have designed into the filter penums.

CLOSING REMARKS OF SESSION CHAIRMAN:

The first two papers dealt with design of filters, systems, and procedures for use on active facilities. Mr. Prinz described the design of a filter system incorporating cylindrical filters in shielded casings which can be installed blindly while still assuring the seal. The filters can be safely inserted and withdrawn from the casing with less difficulty than rectangular filters. The filter itself is of the radial flow type. A special separate containment cell is used to isolate the filter and the hot area during insertion or withdrawal. Possible variations in the system were also described. The filters can be put into drums for ease of disposal. In the question period it was brought out that they could be compacted for disposal.

The second paper by Messrs. Pratt and Hackney was in three sections. In section I they described a double door concept to facilitate filter insertion and withdrawal in active cells. In addition, they described a secondary containment chamber concept which eliminated the effects of gasket seal integrity on filter efficiency. They are described for square section filters but are applicable to cylindrical filters as well. In section II they described the development of circular filters for the same reason that was given by Mr. Prinz. Pratt and Hackney added additional advantages associated with the use of circular filters, i.e., conventional o-rings can be used to seal the filters into cylindrical housing, mating surfaces are easily machined and are compatible with a double lid concept. The filters themselves were both a conventional radial-flow type and an axial-flow type not usually made in such a large size. An extended life radial-flow filter was described which fills the available space in clever fashion. In section III, they described applications of cylindrical filters, including a push-three system of filter change whereby the old is ejected by the new. In addition, a remote change system for filter canisters was described.

The next three papers addressed filter media and applications. Mr. Klein described the development of metallic fiber media for use in prefilters. He described high porosity mats and low porosity sintered webs. The filtering action of these materials was studied using polystyrene latex monodisperse particles and a LAS-X laser aerosol spectrometer. His studies showed that the dominant filtration mechanism was diffusion under the circumstances investigated. Pressure drop and penetration data were given. He then described tests in which the media were loaded with methylene blue and attempts were made to regenerate the preload characteristics by water washing. The methylene blue particles penetrated the high porosity mat deeply and it required a forceful water spray to wash them out. The loading on the low porosity web was mainly on the surface, as on a sieve, and a low pressure water jet was all that was required to regenerate the filter. During questioning, he commented that these material were not yet in service but that applications in incineration processes would be advantageous.

In the last two papers, Dr. Bergman reported on investigations of the filtration effectiveness of commercial electret filter media. He first described the various manufacturing techniques for forming and setting films and fibers in strong electric fields to form the



## 17th DOE NUCLEAR AIR CLEANING CONFERENCE

electrostatic analog of the permanent magnet. The thin films are shredded to form ribbon-like fibers. Electron micrographs were shown indicating very rough surfaces which Dr. Bergman considered important for performance. Initial results that compared the electret material with previously studied glass fiber media sandwiched between metal screening held at high potential difference appeared promising. Dr. Bergman described the effects of water, salt, surfactant, mixtures of these, and organic solvents on performance. Media recovered from water treatment, alone, but salt water and surfactant permanently neutralized the electret charge. Similarly, hydrocarbon solvents irreversibly neutralized charge. During questioning, Dr. Bergman stated that electret materials might be tailored and optimized to overcome these shortcomings. In the paper on applications, Dr. Bergman described electrofibrous filters and their evaluation in the field.

Mr. Furrer reported on a radioactive solid particle tracer method containing 300 mCi of Ba -139 for testing dissolver offgas cleaning trains required to give a DF of  $10^7$  or better. It brought to mind the type of work that Dr. First mentioned at yesterday's opening session is needed in U.S. This technique is very different than the U.S. procedure using DOP. I think we should look into it and see whether the additional sensitivity of  $10^7$ , which was claimed in the paper, can be used for multiple stages of HEPA filters, such as we have at plutonium facilities.

Dr. DuPoux compared different filter testing methods in the U.S. and Europe and pointed out the pressure drop effects on efficiency of HEPA filters. I think this is important because some U.S. facilities routinely change HEPA filters every year, 18 months, or two years.

Shifting into a very different mode, Mr. Ward talked about the philosophy of air cleaning and ventilation criteria for a plutonium facility to satisfy the DOE ALARA concept. The Rocky Flats facility is sensitive to this because of past problems going back to the 1969 fire. I think it puts into perspective that you must identify where you are trying to go before you start designing detailed requirements. He also pointed out the importance of balancing different considerations ranging from health and environmental protection to cost effectiveness and energy conservation. Lastly, Mr. Linck detailed the operating characteristics of one of the two new DOE plutonium facilities. The one at Rocky Flats is, I am sure, the largest and the most sophisticated. I strongly encourage those who have an interest in this to see the slide show which is scheduled for tomorrow afternoon.